

Statistical Mechanics

Entropy, Order Parameters, and  
Complexity

James P. Sethna

Laboratory of Atomic and Solid State Physics, Cornell University, Ithaca, NY  
14853-2501

The author provides this version of this manuscript with the primary intention of making the text accessible electronically—through web searches and for browsing and study on computers. Oxford University Press retains ownership of the copyright. Hard-copy printing, in particular, is subject to the same copyright rules as they would be for a printed book.

CLARENDON PRESS • OXFORD

2017

Copyright Oxford University Press 2006 v1.0

# Preface

The purview of science grows rapidly with time. It is the responsibility of each generation to join new insights to old wisdom, and to distill the key ideas for the next generation. This is my distillation of the last fifty years of statistical mechanics—a period of grand synthesis and great expansion.

This text is careful to address the interests and background not only of physicists, but of sophisticated students and researchers in mathematics, biology, engineering, computer science, and the social sciences. It therefore does not presume an extensive background in physics, and (except for Chapter 7) explicitly does not assume that the reader knows or cares about quantum mechanics. The text treats the intersection of the interests of all of these groups, while the exercises encompass the union of interests. Statistical mechanics will be taught in all of these fields of science in the next generation, whether wholesale or piecemeal by field. By making statistical mechanics useful and comprehensible to a variety of fields, we enrich the subject for those with backgrounds in physics. Indeed, many physicists in their later careers are now taking excursions into these other disciplines.

To make room for these new concepts and applications, much has been pruned. Thermodynamics no longer holds its traditional key role in physics. Like fluid mechanics in the last generation, it remains incredibly useful in certain areas, but researchers in those areas quickly learn it for themselves. Thermodynamics also has not had significant impact in subjects far removed from physics and chemistry: nobody finds Maxwell relations for the stock market, or Clausius–Clapeyron equations applicable to compression algorithms. These and other important topics in thermodynamics have been incorporated into a few key exercises. Similarly, most statistical mechanics texts rest upon examples drawn from condensed matter physics and physical chemistry—examples which are then treated more completely in other courses. Even I, a condensed-matter physicist, find the collapse of white dwarfs more fun than the low-temperature specific heat of metals, and the entropy of card shuffling still more entertaining.

The first half of the text includes standard topics, treated with an interdisciplinary slant. Extensive exercises develop new applications of statistical mechanics: random matrix theory, stock-market volatility, the KAM theorem, Shannon entropy in communications theory, and Dyson’s speculations about life at the end of the Universe. The second half of the text incorporates Monte Carlo methods, order parameters,

linear response and correlations (including a classical derivation of the fluctuation-dissipation theorem), and the theory of abrupt and continuous phase transitions (critical droplet theory and the renormalization group).

This text is aimed for use by upper-level undergraduates and graduate students. A scientifically sophisticated reader with a familiarity with partial derivatives and introductory classical mechanics should find this text accessible, except for Chapter 4 (which demands Hamiltonian mechanics), Chapter 7 (quantum mechanics), Section 8.2 (linear algebra), and Chapter 10 (Fourier methods, introduced in the Appendix). An undergraduate one-semester course might cover Chapters 1–3, 5–7, and 9. Cornell’s hard-working first-year graduate students covered the entire text and worked through perhaps half of the exercises in a semester. I have tried to satisfy all of these audiences through the extensive use of footnotes: think of them as optional hyperlinks to material that is more basic, more advanced, or a sidelight to the main presentation. The exercises are rated by difficulty, from ① (doable by inspection) to ⑤ (advanced); exercises rated ④ many of them computational laboratories) should be assigned sparingly. Much of Chapters 1–3, 5, and 6 was developed in an sophomore honors ‘waves and thermodynamics’ course; these chapters and the exercises marked ① and ② should be accessible to ambitious students early in their college education. A course designed to appeal to an interdisciplinary audience might focus on entropy, order parameters, and critical behavior by covering Chapters 1–3, 5, 6, 8, 9, and 12. The computational exercises in the text grew out of three different semester-long computational laboratory courses. We hope that the computer exercise hints and instructions on the text web site [129] will facilitate their incorporation into similar courses elsewhere.

The current plan is to make individual chapters available as PDF files on the Internet. I also plan to make the figures in this text accessible in a convenient form to those wishing to use them in course or lecture presentations.

I have spent an entire career learning statistical mechanics from friends and colleagues. Since this is a textbook and not a manuscript, the presumption should be that any ideas or concepts expressed are not mine, but rather have become so central to the field that continued attribution would be distracting. I have tried to include references to the literature primarily when it serves my imagined student. In the age of search engines, an interested reader (or writer of textbooks) can quickly find the key ideas and articles on any topic, once they know what it is called. The textbook is now more than ever only a base from which to launch further learning. My thanks to those who have patiently explained their ideas and methods over the years—either in person, in print, or through the Internet.

I must thank explicitly many people who were of tangible assistance in the writing of this book. I would like to thank the National Science Foundation and Cornell’s Laboratory of Atomic and Solid State Physics for their support during the writing of this text. I would like to thank

Pamela Davis Kivelson for the magnificent cover art. I would like to thank Eanna Flanagan, Eric Siggia, Saul Teukolsky, David Nelson, Paul Ginsparg, Vinay Ambegaokar, Neil Ashcroft, David Mermin, Mark Newman, Kurt Gottfried, Chris Henley, Barbara Mink, Tom Rockwell, Csaba Csaki, Peter Lepage, and Bert Halperin for helpful and insightful conversations. Eric Grannan, Piet Brouwer, Michelle Wang, Rick James, Eanna Flanagan, Ira Wasserman, Dale Fixsen, Rachel Bean, Austin Hedeman, Nick Trefethen, Sarah Shandera, Al Sievers, Alex Gaeta, Paul Ginsparg, John Guckenheimer, Dan Stein, and Robert Weiss were of important assistance in developing various exercises. My approach to explaining the renormalization group (Chapter 12) was developed in collaboration with Karin Dahmen, Chris Myers, and Olga Perković. The students in my class have been instrumental in sharpening the text and debugging the exercises; Jonathan McCoy, Austin Hedeman, Bret Hanlon, and Kaden Hazzard in particular deserve thanks. Adam Becker, Surachate (Yor) Limkummerd, Sarah Shandera, Nick Taylor, Quentin Mason, and Stephen Hicks, in their roles of proof-reading, grading, and writing answer keys, were powerful filters for weeding out infelicities. I would like to thank Joel Shore, Mohit Randeria, Mark Newman, Stephen Langer, Chris Myers, Dan Rokhsar, Ben Widom, and Alan Bray for reading portions of the text, providing invaluable insights, and tightening the presentation. I would like to thank Julie Harris at Oxford University Press for her close scrutiny and technical assistance in the final preparation stages of this book. Finally, Chris Myers and I spent hundreds of hours together developing the many computer exercises distributed through this text; his broad knowledge of science and computation, his profound taste in computational tools and methods, and his good humor made this a productive and exciting collaboration. The errors and awkwardness that persist, and the exciting topics I have missed, are in spite of the wonderful input from these friends and colleagues.

I would especially like to thank Carol Devine, for consultation, insightful comments and questions, and for tolerating the back of her spouse's head for perhaps a thousand hours over the past two years.

James P. Sethna  
Ithaca, NY  
February, 2006



# Contents

<b>Preface</b>	<b>v</b>
<b>Contents</b>	<b>ix</b>
<b>List of figures</b>	<b>xvii</b>
<b>1 What is statistical mechanics?</b>	<b>1</b>
Exercises	4
1.1 Quantum dice	4
1.2 Probability distributions	5
1.3 Waiting times	6
1.4 Stirling's approximation	7
1.5 Stirling and asymptotic series	7
1.6 Random matrix theory	8
1.7 Six degrees of separation	9
1.8 Satisfactory map colorings	12
<b>2 Random walks and emergent properties</b>	<b>15</b>
2.1 Random walk examples: universality and scale invariance	15
2.2 The diffusion equation	19
2.3 Currents and external forces	20
2.4 Solving the diffusion equation	22
2.4.1 Fourier	23
2.4.2 Green	23
Exercises	25
2.1 Random walks in grade space	25
2.2 Photon diffusion in the Sun	26
2.3 Molecular motors and random walks	26
2.4 Perfume walk	27
2.5 Generating random walks	28
2.6 Fourier and Green	28
2.7 Periodic diffusion	29
2.8 Thermal diffusion	30
2.9 Frying pan	30
2.10 Polymers and random walks	30
2.11 Stocks, volatility, and diversification	31
2.12 Computational finance: pricing derivatives	32
2.13 Building a percolation network	33

<b>3</b>	<b>Temperature and equilibrium</b>	<b>37</b>
3.1	The microcanonical ensemble	37
3.2	The microcanonical ideal gas	39
3.2.1	Configuration space	39
3.2.2	Momentum space	41
3.3	What is temperature?	44
3.4	Pressure and chemical potential	47
3.4.1	Advanced topic: pressure in mechanics and statistical mechanics.	48
3.5	Entropy, the ideal gas, and phase-space refinements	51
	Exercises	53
3.1	Temperature and energy	54
3.2	Large and very large numbers	54
3.3	Escape velocity	54
3.4	Pressure computation	54
3.5	Hard sphere gas	55
3.6	Connecting two macroscopic systems	55
3.7	Gas mixture	56
3.8	Microcanonical energy fluctuations	56
3.9	Gauss and Poisson	57
3.10	Triple product relation	58
3.11	Maxwell relations	58
3.12	Solving differential equations: the pendulum	58
<b>4</b>	<b>Phase-space dynamics and ergodicity</b>	<b>63</b>
4.1	Liouville's theorem	63
4.2	Ergodicity	65
	Exercises	69
4.1	Equilibration	69
4.2	Liouville vs. the damped pendulum	70
4.3	Invariant measures	70
4.4	Jupiter! and the KAM theorem	72
<b>5</b>	<b>Entropy</b>	<b>77</b>
5.1	Entropy as irreversibility: engines and the heat death of the Universe	77
5.2	Entropy as disorder	81
5.2.1	Entropy of mixing: Maxwell's demon and osmotic pressure	82
5.2.2	Residual entropy of glasses: the roads not taken	83
5.3	Entropy as ignorance: information and memory	85
5.3.1	Non-equilibrium entropy	86
5.3.2	Information entropy	87
	Exercises	90
5.1	Life and the heat death of the Universe	91
5.2	Burning information and Maxwellian demons	91
5.3	Reversible computation	93
5.4	Black hole thermodynamics	93



5.5	Pressure–volume diagram	94
5.6	Carnot refrigerator	95
5.7	Does entropy increase?	95
5.8	The Arnol'd cat map	95
5.9	Chaos, Lyapunov, and entropy increase	96
5.10	Entropy increases: diffusion	97
5.11	Entropy of glasses	97
5.12	Rubber band	98
5.13	How many shuffles?	99
5.14	Information entropy	100
5.15	Shannon entropy	100
5.16	Fractal dimensions	101
5.17	Deriving entropy	102
<b>6</b>	<b>Free energies</b>	<b>105</b>
6.1	The canonical ensemble	106
6.2	Uncoupled systems and canonical ensembles	109
6.3	Grand canonical ensemble	112
6.4	What is thermodynamics?	113
6.5	Mechanics: friction and fluctuations	117
6.6	Chemical equilibrium and reaction rates	118
6.7	Free energy density for the ideal gas	121
	Exercises	123
6.1	Exponential atmosphere	124
6.2	Two-state system	125
6.3	Negative temperature	125
6.4	Molecular motors and free energies	126
6.5	Laplace	127
6.6	Lagrange	128
6.7	Legendre	128
6.8	Euler	128
6.9	Gibbs–Duhem	129
6.10	Clausius–Clapeyron	129
6.11	Barrier crossing	129
6.12	Michaelis–Menten and Hill	131
6.13	Pollen and hard squares	132
6.14	Statistical mechanics and statistics	133
<b>7</b>	<b>Quantum statistical mechanics</b>	<b>135</b>
7.1	Mixed states and density matrices	135
7.1.1	Advanced topic: density matrices.	136
7.2	Quantum harmonic oscillator	139
7.3	Bose and Fermi statistics	140
7.4	Non-interacting bosons and fermions	141
7.5	Maxwell–Boltzmann ‘quantum’ statistics	144
7.6	Black-body radiation and Bose condensation	146
7.6.1	Free particles in a box	146
7.6.2	Black-body radiation	147

7.6.3	Bose condensation	148
7.7	Metals and the Fermi gas	150
	Exercises	151
7.1	Ensembles and quantum statistics	151
7.2	Phonons and photons are bosons	152
7.3	Phase-space units and the zero of entropy	153
7.4	Does entropy increase in quantum systems?	153
7.5	Photon density matrices	154
7.6	Spin density matrix	154
7.7	Light emission and absorption	154
7.8	Einstein's $A$ and $B$	155
7.9	Bosons are gregarious: superfluids and lasers	156
7.10	Crystal defects	157
7.11	Phonons on a string	157
7.12	Semiconductors	157
7.13	Bose condensation in a band	158
7.14	Bose condensation: the experiment	158
7.15	The photon-dominated Universe	159
7.16	White dwarfs, neutron stars, and black holes	160
<b>8</b>	<b>Calculation and computation</b>	<b>163</b>
8.1	The Ising model	163
8.1.1	Magnetism	164
8.1.2	Binary alloys	165
8.1.3	Liquids, gases, and the critical point	166
8.1.4	How to solve the Ising model	166
8.2	Markov chains	167
8.3	What is a phase? Perturbation theory	171
	Exercises	174
8.1	The Ising model	174
8.2	Ising fluctuations and susceptibilities	174
8.3	Coin flips and Markov	176
8.4	Red and green bacteria	176
8.5	Detailed balance	177
8.6	Metropolis	177
8.7	Implementing Ising	177
8.8	Wolff	177
8.9	Implementing Wolff	178
8.10	Stochastic cells	179
8.11	The repressilator	180
8.12	Entropy increases! Markov chains	183
8.13	Hysteresis and avalanches	183
8.14	Hysteresis algorithms	186
8.15	NP-completeness and kSAT	187
<b>9</b>	<b>Order parameters, broken symmetry, and topology</b>	<b>191</b>
9.1	Identify the broken symmetry	192
9.2	Define the order parameter	192








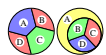



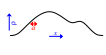























9.3	Examine the elementary excitations	196
9.4	Classify the topological defects	198
	Exercises	203
9.1	Topological defects in nematic liquid crystals	203
9.2	Topological defects in the XY model	204
9.3	Defect energetics and total divergence terms	205
9.4	Domain walls in magnets	206
9.5	Landau theory for the Ising model	206
9.6	Symmetries and wave equations	209
9.7	Superfluid order and vortices	210
9.8	Superfluids: density matrices and ODLRO	211
<b>10</b>	<b>Correlations, response, and dissipation</b>	<b>215</b>
10.1	Correlation functions: motivation	215
10.2	Experimental probes of correlations	217
10.3	Equal-time correlations in the ideal gas	218
10.4	Onsager's regression hypothesis and time correlations	220
10.5	Susceptibility and linear response	222
10.6	Dissipation and the imaginary part	223
10.7	Static susceptibility	224
10.8	The fluctuation-dissipation theorem	227
10.9	Causality and Kramers–Krönig	229
	Exercises	231
10.1	Microwave background radiation	231
10.2	Pair distributions and molecular dynamics	233
10.3	Damped oscillator	235
10.4	Spin	236
10.5	Telegraph noise in nanojunctions	236
10.6	Fluctuation-dissipation: Ising	237
10.7	Noise and Langevin equations	238
10.8	Magnetic dynamics	238
10.9	Quasiparticle poles and Goldstone's theorem	239
<b>11</b>	<b>Abrupt phase transitions</b>	<b>241</b>
11.1	Stable and metastable phases	241
11.2	Maxwell construction	243
11.3	Nucleation: critical droplet theory	244
11.4	Morphology of abrupt transitions	246
11.4.1	Coarsening	246
11.4.2	Martensites	250
11.4.3	Dendritic growth	250
	Exercises	251
11.1	Maxwell and van der Waals	251
11.2	The van der Waals critical point	252
11.3	Interfaces and van der Waals	252
11.4	Nucleation in the Ising model	253
11.5	Nucleation of dislocation pairs	254
11.6	Coarsening in the Ising model	255

11.7	Origami microstructure	255
11.8	Minimizing sequences and microstructure	258
11.9	Snowflakes and linear stability	259
<b>12</b>	<b>Continuous phase transitions</b>	<b>263</b>
12.1	Universality	265
12.2	Scale invariance	272
12.3	Examples of critical points	277
12.3.1	Equilibrium criticality: energy versus entropy	278
12.3.2	Quantum criticality: zero-point fluctuations versus energy	278
12.3.3	Dynamical systems and the onset of chaos	279
12.3.4	Glassy systems: random but frozen	280
12.3.5	Perspectives	281
	Exercises	282
12.1	Ising self-similarity	282
12.2	Scaling and corrections to scaling	282
12.3	Scaling and coarsening	282
12.4	Bifurcation theory	283
12.5	Mean-field theory	284
12.6	The onset of lasing	284
12.7	Renormalization-group trajectories	285
12.8	Superconductivity and the renormalization group	286
12.9	Period doubling	288
12.10	The renormalization group and the central limit theorem: short	291
12.11	The renormalization group and the central limit theorem: long	291
12.12	Percolation and universality	293
12.13	Hysteresis and avalanches: scaling	296
<b>A</b>	<b>Appendix: Fourier methods</b>	<b>299</b>
A.1	Fourier conventions	299
A.2	Derivatives, convolutions, and correlations	302
A.3	Fourier methods and function space	303
A.4	Fourier and translational symmetry	305
	Exercises	307
A.1	Sound wave	307
A.2	Fourier cosines	307
A.3	Double sinusoid	307
A.4	Fourier Gaussians	308
A.5	Uncertainty	309
A.6	Fourier relationships	309
A.7	Aliasing and windowing	310
A.8	White noise	311
A.9	Fourier matching	311
A.10	Gibbs phenomenon	311

<b>References</b>	<b>313</b>
<b>Index</b>	<b>323</b>
<b>EndPapers</b>	<b>350</b>



# List of figures

1.1	Random walks	2		
1.2	Ising model at the critical point	3		
1.3	The onset of chaos	4		
1.4	Quantum dice	5		
1.5	Network	10		
1.6	Small world network	10		
1.7	Betweenness	12		
1.8	Graph coloring	12		
2.1	Drunkard's walk	17		
2.2	Random walk: scale invariance	17		
2.3	S&P 500, normalized	19		
2.4	Continuum limit for random walks	20		
2.5	Conserved current	21		
2.6	Many random walks	24		
2.7	Motor protein	26		
2.8	Effective potential for moving along DNA	26		
2.9	Laser tweezer experiment	27		
2.10	Emergent rotational symmetry	28		
2.11	Initial profile of density	29		
2.12	Bond percolation network	34		
2.13	Site percolation network	35		
3.1	Energy shell	38		
3.2	The energy surface	42		
3.3	Two subsystems	47		
3.4	The surface of state	48		
3.5	Hard sphere gas	55		
3.6	Excluded area around a hard disk	55		
4.1	Conserved currents in 3D	64		
4.2	Incompressible flow	65		
4.3	KAM tori and non-ergodic motion	66		
4.4	Invariant density	72		
4.5	Bifurcation diagram in the chaotic region	72		
4.6	The Earth's trajectory	73		
4.7	Torus	73		
4.8	The Poincaré section	74		

		5.1 Perpetual motion and Carnot	78
		5.2 Prototype heat engine	78
		5.3 Carnot cycle $P$ - $V$ diagram	79
		5.4 Unmixed atoms	82
		5.5 Mixed atoms	82
		5.6 Ion pump	83
		5.7 Double-well potential	84
		5.8 Roads not taken by the glass	85
		5.9 Entropy is concave	88
		5.10 Minimalist digital memory tape	92
		5.11 Expanding piston	92
		5.12 Information-burning engine	92
		5.13 Pistons changing a zero to a one	92
		5.14 Exclusive-or gate	93
		5.15 $P$ - $V$ diagram	94
		5.16 Arnol'd cat transform	96
		5.17 Arnol'd map stretches	96
		5.18 Glass transition specific heat	98
		5.19 Rubber band	98
		5.20 Rational probabilities and conditional entropy	103
		6.1 The canonical ensemble	106
		6.2 Uncoupled systems attached to a common heat bath	109
		6.3 The grand canonical ensemble	112
		6.4 The Gibbs ensemble	116
		6.5 A mass on a spring	117
		6.6 Ammonia collision	118
		6.7 Barrier-crossing potential	120
		6.8 Density fluctuations in space	121
		6.9 Coarse-grained density in space	122
		6.10 Negative temperature	126
		6.11 RNA polymerase molecular motor	126
		6.12 Hairpins in RNA	127
		6.13 Telegraph noise in RNA unzipping	127
		6.14 Generic phase diagram	129
		6.15 Well probability distribution	130
		6.16 Crossing the barrier	130
		6.17 Michaelis-Menten and Hill equation forms	131
		6.18 Square pollen	132
		7.1 The quantum states of the harmonic oscillator	139
		7.2 The specific heat for the quantum harmonic oscillator	140
		7.3 Feynman diagram: identical particles	141
		7.4 Bose-Einstein, Maxwell-Boltzmann, and Fermi-Dirac	142
		7.5 The Fermi distribution $f(\epsilon)$	143
		7.6 Particle in a box	146
		7.7 $k$ -sphere	147
		7.8 The Planck black-body radiation power spectrum	148



7.9 Bose condensation	149		
7.10 The Fermi surface for lithium	150		
7.11 The Fermi surface for aluminum	151		
7.12 Microcanonical three particles	151		
7.13 Canonical three particles	152		
7.14 Grand canonical three particles	152		
7.15 Photon emission from a hole	154		
7.16 Bose–Einstein condensation	158		
7.17 Planck microwave background radiation	159		
8.1 The 2D square-lattice Ising model	164		
8.2 Ising magnetization	164		
8.3 The Ising model as a binary alloy	165		
8.4 P–T phase diagram	166		
8.5 H–T phase diagram for the Ising model	166		
8.6 Bose and Fermi specific heats	171		
8.7 Perturbation theory	172		
8.8 Oil, water, and alcohol	173		
8.9 Cluster flip: before	178		
8.10 Cluster flip: after	178		
8.11 Dimerization reaction	179		
8.12 Biology repressilator	181		
8.13 Computational repressilator	182		
8.14 Barkhausen noise experiment	184		
8.15 Hysteresis loop with subloops	184		
8.16 Tiny jumps: Barkhausen noise	184		
8.17 Avalanche propagation in the hysteresis model	185		
8.18 Avalanche time series	185		
8.19 Using a sorted list	186		
8.20 D–P algorithm	189		
9.1 Quasicrystals	191		
9.2 Which is more symmetric? Cube and sphere	192		
9.3 Which is more symmetric? Ice and water	192		
9.4 Magnetic order parameter	193		
9.5 Nematic order parameter space	194		
9.6 Two-dimensional crystal	194		
9.7 Crystal order parameter space	195		
9.8 One-dimensional sound wave	196		
9.9 Magnets: spin waves	197		
9.10 Nematic liquid crystals: rotational waves	197		
9.11 Dislocation in a crystal	198		
9.12 Loop around the dislocation	199		
9.13 Hedgehog defect	199		
9.14 Defect line in a nematic liquid crystal	200		
9.15 Multiplying two paths	201		
9.16 Two defects: can they cross?	202		
9.17 Pulling off a loop around two defects	202		

		9.18 Non-commuting defects	203
		9.19 Defects in nematic liquid crystals	203
		9.20 XY defect pair	204
		9.21 Looping the defect	205
		9.22 Landau free energy	208
		9.23 Fluctuations on all scales	209
		9.24 Shift symmetry	210
		9.25 Flips and inversion	210
		9.26 Superfluid vortex line	210
		9.27 Delocalization and ODLRO	213
		10.1 Phase separation	216
		10.2 Surface annealing	216
		10.3 Critical fluctuations	217
		10.4 Equal-time correlation function	217
		10.5 Power-law correlations	218
		10.6 X-ray scattering	218
		10.7 Noisy decay of a fluctuation	220
		10.8 Deterministic decay of an initial state	220
		10.9 The susceptibility	226
		10.10 Time-time correlation function	228
		10.11 Cauchy's theorem	230
		10.12 Kramers-Krönig contour	231
		10.13 Map of the microwave background radiation	232
		10.14 Correlation function of microwave radiation	232
		10.15 Pair distribution function	234
		10.16 Telegraph noise in a metallic nanojunction	236
		10.17 Telegraph noise with three metastable states	237
		11.1 $P$ - $T$ and $T$ - $V$ phase diagrams	241
		11.2 Stable and metastable states	242
		11.3 Maxwell equal-area construction	244
		11.4 Vapor bubble	244
		11.5 Free energy barrier	245
		11.6 Equilibrium crystal shape	247
		11.7 Coarsening	247
		11.8 Curvature-driven interface motion	248
		11.9 Coarsening for conserved order parameter	248
		11.10 Logarithmic growth of an interface	249
		11.11 Martensite	250
		11.12 Dendrites	251
		11.13 $P$ - $V$ plot: van der Waals	252
		11.14 Chemical potential: van der Waals	253
		11.15 Dislocation pair	254
		11.16 Paper order parameter space	256
		11.17 Paper crease	256
		11.18 Origami microstructure	257
		11.19 Function with no minimum	258

11.20 Crystal shape coordinates	259	
11.21 Diffusion field ahead of a growing interface	260	
11.22 Snowflake	260	
12.1 The Ising model at $T_c$	263	
12.2 Percolation transition	263	
12.3 Earthquake sizes	265	
12.4 The Burridge–Knopoff model of earthquakes	265	
12.5 A medium-sized avalanche	266	
12.6 Universality	267	
12.7 Universality in percolation	268	
12.8 The renormalization group	269	
12.9 Ising model at $T_c$ : coarse-graining	270	
12.10 Generic and self-organized criticality	271	
12.11 Avalanches: scale invariance	273	
12.12 Scaling near criticality	275	
12.13 Avalanche size distribution	276	
12.14 Superfluid density in helium: scaling plot	278	
12.15 The superconductor–insulator transition	279	
12.16 Self-similarity at the onset of chaos	279	
12.17 Frustration	280	
12.18 Frustration and curvature	281	
12.19 Pitchfork bifurcation diagram	283	
12.20 Fermi liquid theory renormalization-group flows	287	
12.21 Period-eight cycle	288	
12.22 Self-similarity in period-doubling bifurcations	289	
12.23 Renormalization-group transformation	290	
A.1 Approximating the integral as a sum	300	
A.2 The mapping $\mathcal{T}_\Delta$	305	
A.3 Real-space Gaussians	309	
A.4 Fourier matching	312	
A.5 Step function	312	



# What is statistical mechanics?



Many systems in nature are far too complex to analyze directly. Solving for the behavior of all the atoms in a block of ice, or the boulders in an earthquake fault, or the nodes on the Internet, is simply infeasible. Despite this, such systems often show simple, striking behavior. Statistical mechanics explains the simple behavior of complex systems.

The concepts and methods of statistical mechanics have infiltrated into many fields of science, engineering, and mathematics: ensembles, entropy, Monte Carlo, phases, fluctuations and correlations, nucleation, and critical phenomena are central to physics and chemistry, but also play key roles in the study of dynamical systems, communications, bioinformatics, and complexity. Quantum statistical mechanics, although not a source of applications elsewhere, is the foundation of much of physics. Let us briefly introduce these pervasive concepts and methods.

**Ensembles.** The trick of statistical mechanics is not to study a single system, but a large collection or *ensemble* of systems. Where understanding a single system is often impossible, one can often calculate the behavior of a large collection of similarly prepared systems.

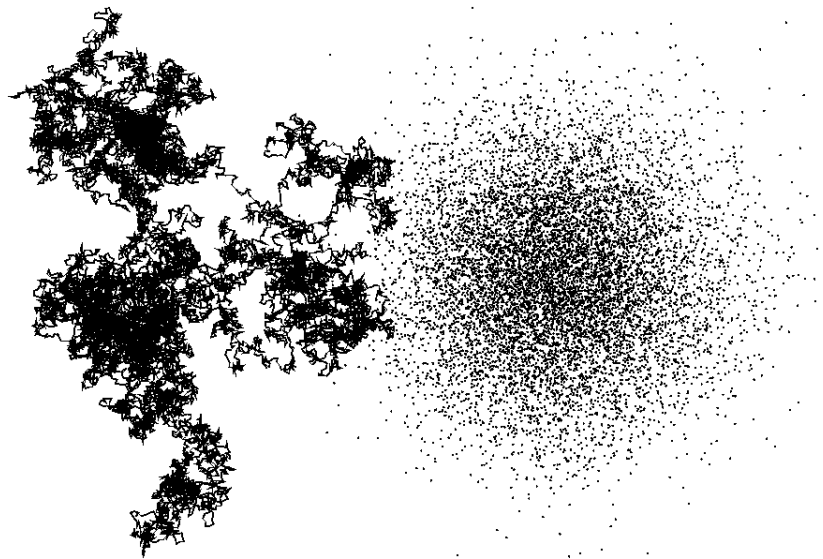
For example, consider a random walk (Fig. 1.1). (Imagine it as the trajectory of a particle in a gas, or the configuration of a polymer in solution.) While the motion of any given walk is irregular and typically impossible to predict, Chapter 2 derives the elegant laws which describe the set of all possible random walks.

Chapter 3 uses an ensemble of all system states of constant energy to derive equilibrium statistical mechanics; the collective properties of temperature, entropy, and pressure emerge from this ensemble. In Chapter 4 we provide the best existing mathematical arguments for this constant-energy ensemble. In Chapter 6 we develop *free energies* which describe parts of systems; by focusing on the important bits, we find new laws that emerge from the microscopic complexity.

**Entropy.** Entropy is the most influential concept arising from statistical mechanics (Chapter 5). It was originally understood as a thermodynamic property of heat engines that inexorably increases with time. Entropy has become science's fundamental measure of disorder and information—quantifying everything from compressing pictures on the Internet to the heat death of the Universe.

**Quantum statistical mechanics**, confined to Chapter 7, provides the microscopic underpinning to much of astrophysics and condensed

**Fig. 1.1 Random walks.** The motion of molecules in a gas, and bacteria in a liquid, and photons in the Sun, are described by *random walks*. Describing the specific trajectory of any given random walk (left) is not feasible. Describing the statistical properties of a large number of random walks is straightforward (right, showing endpoints of many walks starting at the origin). The deep principle underlying statistical mechanics is that it is often easier to understand the behavior of these *ensembles* of systems.



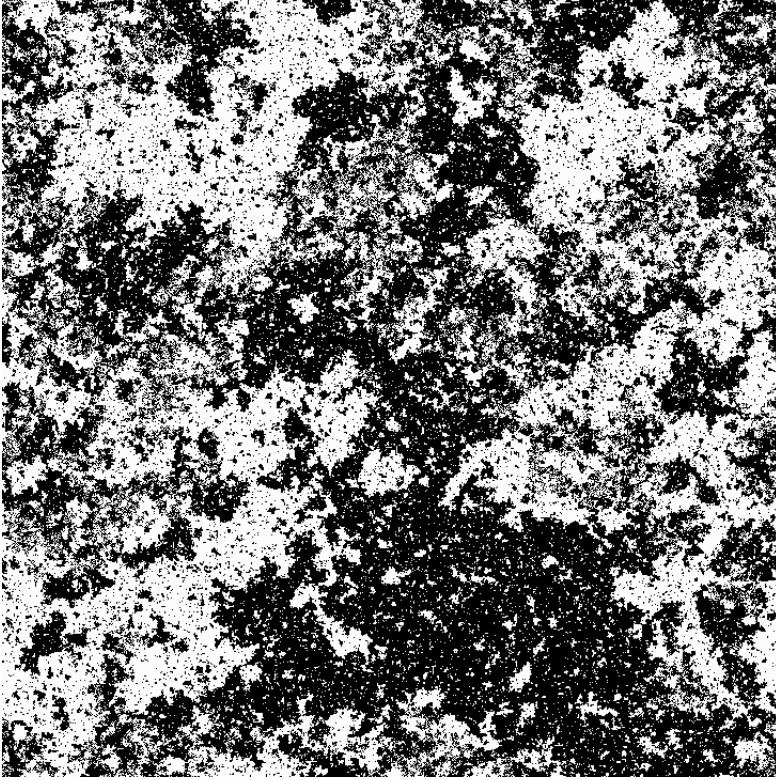
matter physics. There we use it to explain metals, insulators, lasers, stellar collapse, and the microwave background radiation patterns from the early Universe.

**Monte Carlo** methods allow the computer to find ensemble averages in systems far too complicated to allow analytical evaluation. These tools, invented and sharpened in statistical mechanics, are used everywhere in science and technology—from simulating the innards of particle accelerators, to studies of traffic flow, to designing computer circuits. In Chapter 8, we introduce Monte Carlo methods, the Ising model, and the mathematics of Markov chains.

**Phases.** Statistical mechanics explains the existence and properties of phases. The three common phases of matter (solids, liquids, and gases) have multiplied into hundreds: from superfluids and liquid crystals, to vacuum states of the Universe just after the Big Bang, to the pinned and sliding ‘phases’ of earthquake faults. We explain the deep connection between phases and perturbation theory in Section 8.3. In Chapter 9 we introduce the *order parameter field*, which describes the properties, excitations, and topological defects that emerge in a given phase.

**Fluctuations and correlations.** Statistical mechanics not only describes the average behavior of an ensemble of systems, it describes the entire distribution of behaviors. We describe how systems fluctuate and evolve in space and time using *correlation functions* in Chapter 10. There we also derive powerful and subtle relations between correlations, response, and dissipation in equilibrium systems.

**Abrupt Phase Transitions.** Beautiful spatial patterns arise in statistical mechanics at the transitions between phases. Most such transitions are abrupt; ice is crystalline and solid until (at the edge of the ice cube) it becomes unambiguously liquid. We study the nucleation



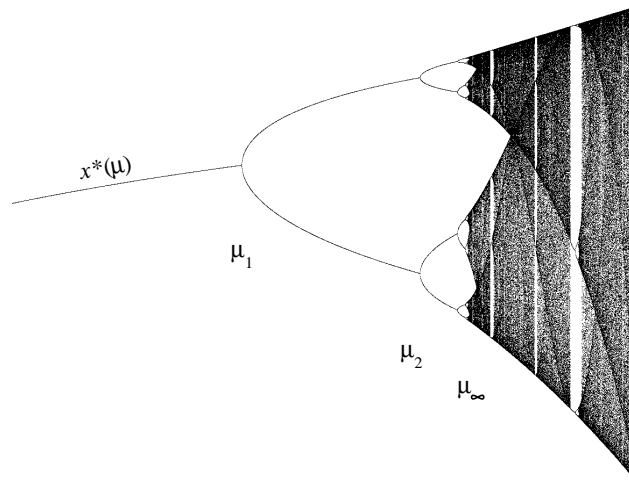
**Fig. 1.2 Ising model at the critical point.** The two-dimensional Ising model of magnetism at its transition temperature  $T_c$ . At higher temperatures, the system is non-magnetic; the magnetization is on average zero. At the temperature shown, the system is just deciding whether to magnetize upward (white) or downward (black).

of new phases and the exotic structures that can form at abrupt phase transitions in Chapter 11.

**Criticality.** Other phase transitions are continuous. Figure 1.2 shows a snapshot of a particular model at its phase transition temperature  $T_c$ . Notice the self-similar, fractal structures; the system cannot decide whether to stay gray or to separate into black and white, so it fluctuates on all scales, exhibiting *critical phenomena*. A random walk also forms a self-similar, fractal object; a blow-up of a small segment of the walk looks statistically similar to the original (Figs 1.1 and 2.2). Chapter 12 develops the scaling and renormalization-group techniques that explain these self-similar, fractal properties. These techniques also explain *universality*; many properties at a continuous transition are surprisingly system independent.

Science grows through accretion, but becomes potent through distillation. Statistical mechanics has grown tentacles into much of science and mathematics (see, e.g., Fig. 1.3). The body of each chapter will provide the distilled version: those topics of fundamental importance to all fields. The accretion is addressed in the exercises: in-depth introductions to applications in mesoscopic physics, astrophysics, dynamical systems, information theory, low-temperature physics, statistics, biology, lasers, and complexity theory.

**Fig. 1.3 The onset of chaos.** Mechanical systems can go from simple, predictable behavior (left) to a chaotic state (right) as some external parameter  $\mu$  is tuned. Many disparate systems are described by a common, *universal* scaling behavior near the onset of chaos (note the replicated structures near  $\mu_\infty$ ). We understand this scaling and universality using tools developed to study continuous transitions in liquids and gases. Conversely, the study of chaotic motion provides statistical mechanics with our best explanation for the increase of entropy.



## Exercises

The first three exercises provide a brief review of probability and probability distributions, mathematical concepts that are central to statistical mechanics. *Quantum dice* explores discrete distributions and also acts as a preview to Bose and Fermi statistics. *Probability distributions* introduces the form and moments for the key distributions for continuous variables and then introduces convolutions and multidimensional distributions. *Waiting times* shows the paradoxes one can concoct by confusing different ensemble averages.

*Stirling's approximation* derives the useful approximation  $n! \sim \sqrt{2\pi n}(n/e)^n$ ; more advanced students can continue with *Stirling and asymptotic series* to explore the zero radius of convergence for this series, often found in perturbative statistical mechanics calculations.

The last three exercises are more challenging: they demand no background in statistical mechanics, yet illustrate both general themes of the subject and the broad range of its applications. *Random matrix theory* briefly introduces an entire active field of research, with applications in nuclear physics, mesoscopic physics, and number theory; part (a) provides a good exercise in histograms and ensembles, and the remaining more advanced parts illustrate level repulsion, the Wigner surmise, universality, and emergent symmetry. *Six degrees of separation*

introduces the ensemble of *small world networks*, popular in the social sciences and epidemiology for modeling the interconnectedness in groups. This computational project introduces network data structures, breadth-first search algorithms, a continuum limit, and our first glimpse of *scaling*. In *Satisfactory map colorings* we introduce the challenging computer science problems of *graph colorability* and *logical satisfiability*: these search through an ensemble of different choices just as statistical mechanics averages over an ensemble of states.

Finally, much of statistical mechanics focuses on the average and typical behavior in an ensemble. There are many applications, however, when it is the extreme case that is of most interest. If a bridge strut has  $N$  microcracks, each with a different failure stress, the engineer is not concerned with the average failure stress but the minimum. Similarly, the insurance company is most interested, not in the typical weather, but the largest likely hurricane. This introduces the study of *extreme value statistics*, and the *Weibull* and *Gumbel* distributions. A post-publication exercise on this subject is planned for the book web site [126].

(1.1) **Quantum dice.**<sup>1</sup> (Quantum) ②

You are given several unusual ‘three-sided’ dice which, when rolled, show either one, two, or three

<sup>1</sup>This exercise was developed in collaboration with Sarah Shandera.



spots. There are three games played with these dice: *Distinguishable*, *Bosons*, and *Fermions*. In each turn in these games, the player rolls one die at a time, starting over if required by the rules, until a legal combination occurs. In *Distinguishable*, all rolls are legal. In *Bosons*, a roll is legal only if the new number is larger or equal to the preceding number. In *Fermions*, a roll is legal only if the new number is strictly larger than the preceding number. See Fig. 1.4 for a table of possibilities after rolling two dice.

Our dice rules are the same ones that govern the quantum statistics of identical particles.

	1	2	3
3	4	5	6
2	3	4	5
1	2	3	4
	1	2	3

**Fig. 1.4 Quantum dice.** Rolling two dice. In *Bosons*, one accepts only the rolls in the shaded squares, with equal probability 1/6. In *Fermions*, one accepts only the rolls in the darkly-shaded squares (not including the diagonal from lower left to upper right), with probability 1/3.

(a) Presume the dice are fair: each of the three numbers of dots shows up 1/3 of the time. For a legal turn rolling a die twice in *Bosons*, what is the probability  $\rho(4)$  of rolling a 4? Similarly, among the legal *Fermion* turns rolling two dice, what is the probability  $\rho(4)$ ?

(b) For a legal turn rolling three ‘three-sided’ dice in *Fermions*, what is the probability  $\rho(6)$  of rolling a 6? (Hint: There is a Fermi exclusion principle: when playing *Fermions*, no two dice can have the same number of dots showing.) Electrons are fermions; no two electrons can be in exactly the same state.

When rolling two dice in *Bosons*, there are six different legal turns (11), (12), (13), . . . , (33); half of them are doubles (both numbers equal), while for plain old *Distinguishable* turns only one-third would be doubles<sup>2</sup>; the probability of getting doubles is enhanced by 1.5 times in two-roll *Bosons*. When rolling three dice in *Bosons*, there are ten

different legal turns (111), (112), (113), . . . , (333). When rolling  $M$  dice each with  $N$  sides in *Bosons*, one can show that there are

$$\binom{N + M - 1}{M} = \frac{(N + M - 1)!}{M!(N - 1)!}$$

legal turns.

(c) In a turn of three rolls, what is the factor by which the probability of getting triples in *Bosons* is enhanced over that in *Distinguishable*? In a turn of  $M$  rolls, what is the enhancement factor for generating an  $M$ -tuple (all rolls having the same number of dots showing)?

Notice that the states of the dice tend to cluster together in *Bosons*. Examples of real bosons clustering into the same state include Bose condensation (Section 7.6.3) and lasers (Exercise 7.9).

(1.2) **Probability distributions.** ②

Most people are more familiar with probabilities for discrete events (like coin flips and card games), than with probability distributions for continuous variables (like human heights and atomic velocities). The three continuous probability distributions most commonly encountered in physics are: (i) *uniform*:  $\rho_{\text{uniform}}(x) = 1$  for  $0 \leq x < 1$ ,  $\rho(x) = 0$  otherwise (produced by random number generators on computers); (ii) *exponential*:  $\rho_{\text{exponential}}(t) = e^{-t/\tau}/\tau$  for  $t \geq 0$  (familiar from radioactive decay and used in the collision theory of gases); and (iii) *Gaussian*:  $\rho_{\text{gaussian}}(v) = e^{-v^2/2\sigma^2}/(\sqrt{2\pi}\sigma)$ , (describing the probability distribution of velocities in a gas, the distribution of positions at long times in random walks, the sums of random variables, and the solution to the diffusion equation).

(a) Likelihoods. What is the probability that a random number uniform on  $[0, 1)$  will happen to lie between  $x = 0.7$  and  $x = 0.75$ ? That the waiting time for a radioactive decay of a nucleus will be more than twice the exponential decay time  $\tau$ ? That your score on an exam with a Gaussian distribution of scores will be greater than  $2\sigma$  above the mean? (Note:  $\int_2^\infty (1/\sqrt{2\pi}) \exp(-v^2/2) dv = (1 - \text{erf}(\sqrt{2}))/2 \sim 0.023$ .)

(b) Normalization, mean, and standard deviation. Show that these probability distributions are normalized:  $\int \rho(x) dx = 1$ . What is the mean  $x_0$  of each distribution? The standard deviation  $\sqrt{\int (x - x_0)^2 \rho(x) dx}$ ? (You may use

<sup>2</sup>For *Fermions*, of course, there are no doubles.

the formulæ  $\int_{-\infty}^{\infty} (1/\sqrt{2\pi}) \exp(-v^2/2) dv = 1$  and  $\int_{-\infty}^{\infty} v^2(1/\sqrt{2\pi}) \exp(-v^2/2) dv = 1.$

(c) Sums of variables. Draw a graph of the probability distribution of the sum  $x + y$  of two random variables drawn from a uniform distribution on  $[0, 1]$ . Argue in general that the sum  $z = x + y$  of random variables with distributions  $\rho_1(x)$  and  $\rho_2(y)$  will have a distribution given by  $\rho(z) = \int \rho_1(x)\rho_2(z - x) dx$  (the convolution of  $\rho$  with itself).

*Multidimensional probability distributions.* In statistical mechanics, we often discuss probability distributions for many variables at once (for example, all the components of all the velocities of all the atoms in a box). Let us consider just the probability distribution of one molecule's velocities. If  $v_x, v_y,$  and  $v_z$  of a molecule are independent and each distributed with a Gaussian distribution with  $\sigma = \sqrt{kT/M}$  (Section 3.2.2) then we describe the combined probability distribution as a function of three variables as the product of the three Gaussians:

$$\begin{aligned} \rho(v_x, v_y, v_z) &= \frac{1}{(2\pi(kT/M))^{3/2}} \exp(-M\mathbf{v}^2/2kT) \\ &= \sqrt{\frac{M}{2\pi kT}} \exp\left(\frac{-Mv_x^2}{2kT}\right) \\ &\quad \times \sqrt{\frac{M}{2\pi kT}} \exp\left(\frac{-Mv_y^2}{2kT}\right) \\ &\quad \times \sqrt{\frac{M}{2\pi kT}} \exp\left(\frac{-Mv_z^2}{2kT}\right). \end{aligned} \quad (1.1)$$

(d) Show, using your answer for the standard deviation of the Gaussian in part (b), that the mean kinetic energy is  $kT/2$  per dimension. Show that the probability that the speed is  $v = |\mathbf{v}|$  is given by a Maxwellian distribution

$$\rho_{\text{Maxwell}}(v) = \sqrt{2/\pi}(v^2/\sigma^3) \exp(-v^2/2\sigma^2). \quad (1.2)$$

(Hint: What is the shape of the region in 3D velocity space where  $|\mathbf{v}|$  is between  $v$  and  $v + \delta v$ ? The surface area of a sphere of radius  $R$  is  $4\pi R^2$ .)

(1.3) **Waiting times.**<sup>3</sup> (Mathematics) ③

On a highway, the average numbers of cars and buses going east are equal: each hour, on average, there are 12 buses and 12 cars passing by. The buses are scheduled: each bus appears exactly 5 minutes after the previous one. On the

other hand, the cars appear at random: in a short interval  $dt$ , the probability that a car comes by is  $dt/\tau$ , with  $\tau = 5$  minutes. An observer is counting the cars and buses.

(a) Verify that each hour the average number of cars passing the observer is 12.

(b) What is the probability  $P_{\text{bus}}(n)$  that  $n$  buses pass the observer in a randomly chosen 10 minute interval? And what is the probability  $P_{\text{car}}(n)$  that  $n$  cars pass the observer in the same time interval? (Hint: For the cars, one way to proceed is to divide the interval into many small slivers of time  $dt$ ; in each sliver the probability is  $dt/\tau$  that a car passes, and  $1 - dt/\tau \approx e^{-dt/\tau}$  that no car passes. However you do it, you should get a Poisson distribution,  $P_{\text{car}}(n) = a^n e^{-a}/n!$ . See also Exercise 3.9.)

(c) What are the probability distributions  $\rho_{\text{bus}}$  and  $\rho_{\text{car}}$  for the time interval  $\Delta$  between two successive buses and cars, respectively? What are the means of these distributions? (Hint: To write the probability distribution for the bus, you will need to use the Dirac  $\delta$ -function.<sup>4</sup>)

(d) If another observer arrives at the road at a randomly chosen time, what is the probability distribution for the time  $\Delta$  she has to wait for the first bus to arrive? What is the probability distribution for the time she has to wait for the first car to pass by? (Hint: What would the distribution of waiting times be just after a car passes by? Does the time of the next car depend at all on the previous car?) What are the means of these distributions?

The mean time between cars is 5 minutes. The mean time to the next car should be 5 minutes. A little thought should convince you that the mean time since the last car should also be 5 minutes. But  $5 + 5 \neq 5$ ; how can this be?

The same physical quantity can have different means when averaged in different ensembles! The mean time between cars in part (c) was a gap average: it weighted all gaps between cars equally. The mean time to the next car from part (d) was a time average: the second observer arrives with equal probability at every time, so is twice as likely to arrive during a gap between cars that is twice as long.

(e) In part (c),  $\rho_{\text{car}}^{\text{gap}}(\Delta)$  was the probability that a randomly chosen gap was of length  $\Delta$ . Write a

<sup>3</sup>This exercise was developed in collaboration with Piet Brouwer.

<sup>4</sup>The  $\delta$ -function  $\delta(x-x_0)$  is a probability density which has 100% probability of being in any interval containing  $x_0$ ; thus  $\delta(x-x_0)$  is zero unless  $x = x_0$ , and  $\int f(x)\delta(x-x_0) dx = f(x_0)$  so long as the domain of integration includes  $x_0$ . Mathematically, this is not a function, but rather a distribution or a measure.

formula for  $\rho_{\text{car}}^{\text{time}}(\Delta)$ , the probability that the second observer, arriving at a randomly chosen time, will be in a gap between cars of length  $\Delta$ . (Hint: Make sure it is normalized.) From  $\rho_{\text{car}}^{\text{time}}(\Delta)$ , calculate the average length of the gaps between cars, using the time-weighted average measured by the second observer.

(1.4) **Stirling's approximation.** (Mathematics) ② Stirling's approximation [123] for  $n!$ , valid for large  $n$ , is extremely useful in statistical mechanics.

Show, by converting the sum to an integral, that  $\log(n!) = \sum_1^n \log n \sim (n + \frac{1}{2}) \log(n + \frac{1}{2}) - n - \frac{1}{2} \log(\frac{1}{2})$ . (As always in this book,  $\log$  represents the natural logarithm, not  $\log_{10}$ .) Show that this is compatible with the more precise and traditional formula  $n! \approx (n/e)^n \sqrt{2\pi n}$ ; in particular, show that the difference between the logs of the two formulae goes to a constant as  $n \rightarrow \infty$ . Show that the latter is compatible with the first term in the series we use in Exercise 1.5,  $n! \sim (2\pi/(n+1))^{\frac{1}{2}} e^{-(n+1)} (n+1)^{n+1}$ , in that the difference between the logs goes to zero as  $n \rightarrow \infty$ . (Related formulae:  $\int \log x dx = x \log x - x$ , and  $\log(n+1) - \log(n) = \log(1 + 1/n) \sim 1/n$  up to terms of order  $1/n^2$ .)

(1.5) **Stirling and asymptotic series.** (Mathematics) ③

Stirling's formula (which is actually originally due to de Moivre) can be improved upon by extending it into an entire series. It is not a traditional Taylor expansion; rather, it is an *asymptotic series*. Asymptotic series are important in many fields of applied mathematics, statistical mechanics [121], and field theory [122].

We want to expand  $n!$  for large  $n$ ; to do this, we need to turn it into a continuous function, interpolating between the integers. This continuous function, with its argument perversely shifted by one, is  $\Gamma(z) = (z-1)!$ . There are many equivalent formulae for  $\Gamma(z)$ ; indeed, any formula giving an analytic function satisfying the recursion relation  $\Gamma(z+1) = z\Gamma(z)$  and the normalization  $\Gamma(1) = 1$  is equivalent (by theorems of complex analysis). We will not use it here, but a typical definition is  $\Gamma(z) = \int_0^\infty e^{-t} t^{z-1} dt$ ; one can integrate by parts to show that  $\Gamma(z+1) = z\Gamma(z)$ .

(a) Show, using the recursion relation  $\Gamma(z+1) = z\Gamma(z)$ , that  $\Gamma(z)$  has a singularity (goes to infinity) at all the negative integers.

Stirling's formula is extensible [13, p. 218] into a nice expansion of  $\Gamma(z)$  in powers of  $1/z = z^{-1}$ :

$$\begin{aligned} \Gamma[z] &= (z-1)! \\ &\sim (2\pi/z)^{\frac{1}{2}} e^{-z} z^z (1 + (1/12)z^{-1} \\ &\quad + (1/288)z^{-2} - (139/51840)z^{-3} \\ &\quad - (571/2488320)z^{-4} \\ &\quad + (163879/209018880)z^{-5} \\ &\quad + (5246819/75246796800)z^{-6} \\ &\quad - (534703531/902961561600)z^{-7} \\ &\quad - (4483131259/86684309913600)z^{-8} \\ &\quad + \dots). \end{aligned} \tag{1.3}$$

This looks like a Taylor series in  $1/z$ , but is subtly different. For example, we might ask what the radius of convergence [125] of this series is. The radius of convergence is the distance to the nearest singularity in the complex plane (see note 27 on p. 173 and Fig. 8.7(a)).

(b) Let  $g(\zeta) = \Gamma(1/\zeta)$ ; then Stirling's formula is something times a Taylor series in  $\zeta$ . Plot the poles (singularities) of  $g(\zeta)$  in the complex  $\zeta$  plane that you found in part (a). Show that the radius of convergence of Stirling's formula applied to  $g$  must be zero, and hence no matter how large  $z$  is Stirling's formula eventually diverges.

Indeed, the coefficient of  $z^{-j}$  eventually grows rapidly; Bender and Orszag [13, p. 218] state that the odd coefficients ( $A_1 = 1/12$ ,  $A_3 = -139/51840$ , ...) asymptotically grow as

$$A_{2j+1} \sim (-1)^j 2(2j)! / (2\pi)^{2(j+1)}. \tag{1.4}$$

(c) Show explicitly, using the ratio test applied to formula 1.4, that the radius of convergence of Stirling's formula is indeed zero.<sup>5</sup>

This in no way implies that Stirling's formula is not valuable! An asymptotic series of length  $n$  approaches  $f(z)$  as  $z$  gets big, but for fixed  $z$  it can diverge as  $n$  gets larger and larger. In fact, asymptotic series are very common, and often are useful for much larger regions than are Taylor series.

(d) What is  $0!$ ? Compute  $0!$  using successive terms in Stirling's formula (summing to  $A_N$  for

<sup>5</sup>If you do not remember about radius of convergence, see [125]. Here you will be using every other term in the series, so the radius of convergence is  $\sqrt{|A_{2j-1}/A_{2j+1}|}$ .

the first few  $N$ ). Considering that this formula is expanding about infinity, it does pretty well! Quantum electrodynamics these days produces the most precise predictions in science. Physicists sum enormous numbers of Feynman diagrams to produce predictions of fundamental quantum phenomena. Dyson argued that quantum electrodynamics calculations give an asymptotic series [122]; the most precise calculation in science takes the form of a series which cannot converge. Many other fundamental expansions are also asymptotic series; for example, Hooke's law and elastic theory have zero radius of convergence [21, 22].

(1.6) **Random matrix theory.**<sup>6</sup> (Mathematics, Quantum) ③

One of the most active and unusual applications of ensembles is *random matrix theory*, used to describe phenomena in nuclear physics, mesoscopic quantum mechanics, and wave phenomena. Random matrix theory was invented in a bold attempt to describe the statistics of energy level spectra in nuclei. In many cases, the statistical behavior of systems exhibiting complex wave phenomena—almost any correlations involving eigenvalues and eigenstates—can be quantitatively modeled using ensembles of matrices with completely random, uncorrelated entries!

To do this exercise, you will need to find a software environment in which it is easy to (i) make histograms and plot functions on the same graph, (ii) find eigenvalues of matrices, sort them, and collect the differences between neighboring ones, and (iii) generate symmetric random matrices with Gaussian and integer entries. Mathematica, Matlab, Octave, and Python are all good choices. For those who are not familiar with one of these packages, I will post hints on how to do these three things under 'Random matrix theory' in the computer exercises section of the book web site [129]. The most commonly explored ensemble of matrices is the Gaussian orthogonal ensemble (GOE). Generating a member  $H$  of this ensemble of size  $N \times N$  takes two steps.

- Generate an  $N \times N$  matrix whose elements are independent random numbers with Gaussian distributions of mean zero and standard deviation  $\sigma = 1$ .

- Add each matrix to its transpose to symmetrize it.

As a reminder, the Gaussian or normal probability distribution of mean zero gives a random number  $x$  with probability

$$\rho(x) = \frac{1}{\sqrt{2\pi}\sigma} e^{-x^2/2\sigma^2}. \quad (1.5)$$

One of the most striking properties that large random matrices share is the distribution of level splittings.

(a) Generate an ensemble with  $M = 1000$  or so GOE matrices of size  $N = 2, 4,$  and  $10$ . (More is nice.) Find the eigenvalues  $\lambda_n$  of each matrix, sorted in increasing order. Find the difference between neighboring eigenvalues  $\lambda_{n+1} - \lambda_n$ , for  $n$ , say, equal to  $\frac{7}{8} N/2$ . Plot a histogram of these eigenvalue splittings divided by the mean splitting, with bin size small enough to see some of the fluctuations. (Hint: Debug your work with  $M = 10$ , and then change to  $M = 1000$ .)

What is this dip in the eigenvalue probability near zero? It is called *level repulsion*.

For  $N = 2$  the probability distribution for the eigenvalue splitting can be calculated pretty simply. Let our matrix be  $M = \begin{pmatrix} a & b \\ b & c \end{pmatrix}$ .

(b) Show that the eigenvalue difference for  $M$  is  $\lambda = \sqrt{(c-a)^2 + 4b^2} = 2\sqrt{d^2 + b^2}$  where  $d = (c-a)/2$ , and the trace  $c+a$  is irrelevant. Ignoring the trace, the probability distribution of matrices can be written  $\rho_M(d, b)$ . What is the region in the  $(b, d)$  plane corresponding to the range of eigenvalue splittings  $(\lambda, \lambda + \Delta)$ ? If  $\rho_M$  is continuous and finite at  $d = b = 0$ , argue that the probability density  $\rho(\lambda)$  of finding an eigenvalue splitting near  $\lambda = 0$  vanishes (level repulsion). (Hint: Both  $d$  and  $b$  must vanish to make  $\lambda = 0$ . Go to polar coordinates, with  $\lambda$  the radius.)

(c) Calculate analytically the standard deviation of a diagonal and an off-diagonal element of the GOE ensemble (made by symmetrizing Gaussian random matrices with  $\sigma = 1$ ). You may want to check your answer by plotting your predicted Gaussians over the histogram of  $H_{11}$  and  $H_{12}$  from your ensemble in part (a). Calculate analytically the standard deviation of  $d = (c-a)/2$  of the  $N = 2$  GOE ensemble of part (b), and show that it equals the standard deviation of  $b$ .

(d) Calculate a formula for the probability dis-

<sup>6</sup>This exercise was developed with the help of Piet Brouwer.

<sup>7</sup>Why not use all the eigenvalue splittings? The mean splitting can change slowly through the spectrum, smearing the distribution a bit.

tribution of eigenvalue spacings for the  $N = 2$  GOE, by integrating over the probability density  $\rho_M(d, b)$ . (Hint: Polar coordinates again.)

If you rescale the eigenvalue splitting distribution you found in part (d) to make the mean splitting equal to one, you should find the distribution

$$\rho_{\text{Wigner}}(s) = \frac{\pi s}{2} e^{-\pi s^2/4}. \quad (1.6)$$

This is called the *Wigner surmise*; it is within 2% of the correct answer for larger matrices as well.<sup>8</sup>

(e) Plot eqn 1.6 along with your  $N = 2$  results from part (a). Plot the Wigner surmise formula against the plots for  $N = 4$  and  $N = 10$  as well.

Does the distribution of eigenvalues depend in detail on our GOE ensemble? Or could it be *universal*, describing other ensembles of real symmetric matrices as well? Let us define a  $\pm 1$  ensemble of real symmetric matrices, by generating an  $N \times N$  matrix whose elements are independent random variables, each  $\pm 1$  with equal probability.

(f) Generate an ensemble of  $M = 1000$  symmetric matrices filled with  $\pm 1$  with size  $N = 2, 4,$  and  $10$ . Plot the eigenvalue distributions as in part (a). Are they universal (independent of the ensemble up to the mean spacing) for  $N = 2$  and  $4$ ? Do they appear to be nearly universal<sup>9</sup> (the same as for the GOE in part (a)) for  $N = 10$ ? Plot the Wigner surmise along with your histogram for  $N = 10$ .

The GOE ensemble has some nice statistical properties. The ensemble is invariant under orthogonal transformations:

$$H \rightarrow R^T H R \quad \text{with} \quad R^T = R^{-1}. \quad (1.7)$$

(g) Show that  $\text{Tr}[H^T H]$  is the sum of the squares of all elements of  $H$ . Show that this trace is invariant under orthogonal coordinate transformations (that is,  $H \rightarrow R^T H R$  with  $R^T = R^{-1}$ ). (Hint: Remember, or derive, the cyclic invariance of the trace:  $\text{Tr}[ABC] = \text{Tr}[CAB]$ .)

Note that this trace, for a symmetric matrix, is the sum of the squares of the diagonal elements plus *twice* the squares of the upper triangle of off-diagonal elements. That is convenient, because in our GOE ensemble the variance (squared standard deviation) of the off-diagonal elements is half that of the diagonal elements (part (c)).

(h) Write the probability density  $\rho(H)$  for finding GOE ensemble member  $H$  in terms of the trace

formula in part (g). Argue, using your formula and the invariance from part (g), that the GOE ensemble is invariant under orthogonal transformations:  $\rho(R^T H R) = \rho(H)$ .

This is our first example of an *emergent symmetry*. Many different ensembles of symmetric matrices, as the size  $N$  goes to infinity, have eigenvalue and eigenvector distributions that are invariant under orthogonal transformations *even though the original matrix ensemble did not have this symmetry*. Similarly, rotational symmetry emerges in random walks on the square lattice as the number of steps  $N$  goes to infinity, and also emerges on long length scales for Ising models at their critical temperatures.

(1.7) **Six degrees of separation.**<sup>10</sup> (Complexity, Computation) ④

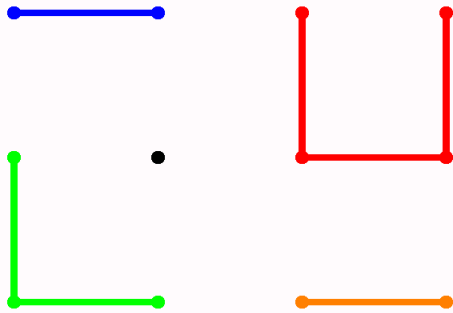
One of the more popular topics in random network theory is the study of how connected they are. ‘Six degrees of separation’ is the phrase commonly used to describe the interconnected nature of human acquaintances: various somewhat uncontrolled studies have shown that any random pair of people in the world can be connected to one another by a short chain of people (typically around six), each of whom knows the next fairly well. If we represent people as nodes and acquaintanceships as neighbors, we reduce the problem to the study of the relationship network.

Many interesting problems arise from studying properties of randomly generated networks. A network is a collection of *nodes* and *edges*, with each edge connected to two nodes, but with each node potentially connected to any number of edges (Fig. 1.5). A random network is constructed probabilistically according to some definite rules; studying such a random network usually is done by studying the entire ensemble of networks, each weighted by the probability that it was constructed. Thus these problems naturally fall within the broad purview of statistical mechanics.

<sup>8</sup>The distribution for large matrices is known and universal, but is much more complicated to calculate.

<sup>9</sup>Note the spike at zero. There is a small probability that two rows or columns of our matrix of  $\pm 1$  will be the same, but this probability vanishes rapidly for large  $N$ .

<sup>10</sup>This exercise and the associated software were developed in collaboration with Christopher Myers.



**Fig. 1.5 Network.** A network is a collection of nodes (circles) and edges (lines between the circles).

In this exercise, we will generate some random networks, and calculate the distribution of distances between pairs of points. We will study *small world networks* [95,142], a theoretical model that suggests how a small number of shortcuts (unusual international and intercultural friendships) can dramatically shorten the typical chain lengths. Finally, we will study how a simple, universal scaling behavior emerges for large networks with few shortcuts.

In the computer exercises section on the book web site [129], you will find some hint files and graphic routines to facilitate working this exercise. We plan to support a variety of languages and systems.

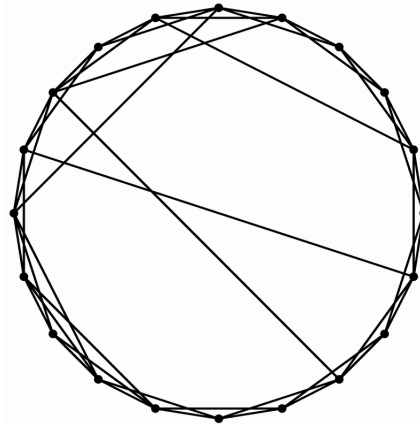
*Constructing a small world network.* The  $L$  nodes in a small world network are arranged around a circle. There are two kinds of edges. Each node has  $Z$  short edges connecting it to its nearest neighbors around the circle (up to a distance  $Z/2$ ). In addition, there are  $p \times L \times Z/2$  shortcuts added to the network, which connect nodes at random (see Fig. 1.6). (This is a more tractable version [95] of the original model [142], which rewired a fraction  $p$  of the  $LZ/2$  edges.)

(a) Define a network object on the computer. For this exercise, the nodes will be represented by integers. Implement a network class, with five functions:

- (1) `HasNode(node)`, which checks to see if a node is already in the network;
- (2) `AddNode(node)`, which adds a new node to the

system (if it is not already there);

- (3) `AddEdge(node1, node2)`, which adds a new edge to the system;
- (4) `GetNodes()`, which returns a list of existing nodes; and
- (5) `GetNeighbors(node)`, which returns the neighbors of an existing node.



**Fig. 1.6 Small world network** with  $L = 20$ ,  $Z = 4$ , and  $p = 0.2$ .<sup>11</sup>

Write a routine to construct a small world network, which (given  $L$ ,  $Z$ , and  $p$ ) adds the nodes and the short edges, and then randomly adds the shortcuts. Use the software provided to draw this small world graph, and check that you have implemented the periodic boundary conditions correctly (each node  $i$  should be connected to nodes  $(i - Z/2) \bmod L, \dots, (i + Z/2) \bmod L$ ).<sup>12</sup>

*Measuring the minimum distances between nodes.* The most studied property of small world graphs is the distribution of shortest paths between nodes. Without the long edges, the shortest path between  $i$  and  $j$  will be given by hopping in steps of length  $Z/2$  along the shorter of the two arcs around the circle; there will be no paths of length longer than  $L/Z$  (half-way around the circle), and the distribution  $\rho(\ell)$  of path lengths  $\ell$  will be constant for  $0 < \ell < L/Z$ . When we add shortcuts, we expect that the distribution will be shifted to shorter path lengths.

<sup>11</sup>There are seven new shortcuts, where  $pLZ/2 = 8$ ; one of the added edges overlapped an existing edge or connected a node to itself.

<sup>12</sup>Here  $(i - Z/2) \bmod L$  is the integer  $0 \leq n \leq L - 1$  which differs from  $i - Z/2$  by a multiple of  $L$ .

(b) Write the following three functions to find and analyze the path length distribution.

(1) `FindPathLengthsFromNode(graph, node)`, which returns for each `node2` in the graph the shortest distance from `node` to `node2`. An efficient algorithm is a breadth-first traversal of the graph, working outward from `node` in shells. There will be a `currentShell` of nodes whose distance will be set to  $\ell$  unless they have already been visited, and a `nextShell` which will be considered after the current one is finished (looking sideways before forward, breadth first), as follows.

- Initialize  $\ell = 0$ , the distance from `node` to itself to zero, and `currentShell = [node]`.
- While there are nodes in the new `currentShell`:
  - \* start a new empty `nextShell`;
  - \* for each neighbor of each node in the current shell, if the distance to `neighbor` has not been set, add the node to `nextShell` and set the distance to  $\ell + 1$ ;
  - \* add one to  $\ell$ , and set the current shell to `nextShell`.
- Return the distances.

This will sweep outward from `node`, measuring the shortest distance to every other node in the network. (Hint: Check your code with a network with small  $N$  and small  $p$ , comparing a few paths to calculations by hand from the graph image generated as in part (a).)

- (2) `FindAllPathLengths(graph)`, which generates a list of all lengths (one per pair of nodes in the graph) by repeatedly using `FindPathLengthsFromNode`. Check your function by testing that the histogram of path lengths at  $p = 0$  is constant for  $0 < \ell < L/Z$ , as advertised. Generate graphs at  $L = 1000$  and  $Z = 2$  for  $p = 0.02$  and  $p = 0.2$ ; display the circle graphs and plot the histogram of path lengths. Zoom in on the histogram; how much does it change with  $p$ ? What value of  $p$  would you need to get ‘six degrees of separation’?
- (3) `FindAveragePathLength(graph)`, which computes the mean  $\langle \ell \rangle$  over all pairs of nodes.

Compute  $\ell$  for  $Z = 2$ ,  $L = 100$ , and  $p = 0.1$  a few times; your answer should be around  $\ell = 10$ . Notice that there are substantial statistical fluctuations in the value from sample to sample. Roughly how many long bonds are there in this system? Would you expect fluctuations in the distances?

(c) Plot the average path length between nodes  $\ell(p)$  divided by  $\ell(p = 0)$  for  $Z = 2$ ,  $L = 50$ , with  $p$  on a semi-log plot from  $p = 0.001$  to  $p = 1$ . (Hint: Your curve should be similar to that of Watts and Strogatz [142, fig. 2], with the values of  $p$  shifted by a factor of 100; see the discussion of the continuum limit below.) Why is the graph fixed at one for small  $p$ ?

*Large  $N$  and the emergence of a continuum limit.* We can understand the shift in  $p$  of part (c) as a continuum limit of the problem. In the limit where the number of nodes  $N$  becomes large and the number of shortcuts  $pLZ/2$  stays fixed, this network problem has a nice limit where distance is measured in radians  $\Delta\theta$  around the circle. Dividing  $\ell$  by  $\ell(p = 0) \approx L/(2Z)$  essentially does this, since  $\Delta\theta = \pi Z\ell/L$ .

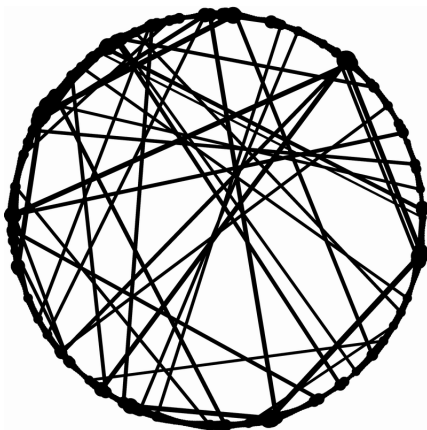
(d) Create and display a circle graph of your geometry from part (c) ( $Z = 2$ ,  $L = 50$ ) at  $p = 0.1$ ; create and display circle graphs of Watts and Strogatz’s geometry ( $Z = 10$ ,  $L = 1000$ ) at  $p = 0.1$  and  $p = 0.001$ . Which of their systems looks statistically more similar to yours? Plot (perhaps using the scaling collapse routine provided) the rescaled average path length  $\pi Z\ell/L$  versus the total number of shortcuts  $pLZ/2$ , for a range  $0.001 < p < 1$ , for  $L = 100$  and  $200$ , and for  $Z = 2$  and  $4$ .

In this limit, the average bond length  $\langle \Delta\theta \rangle$  should be a function only of  $M$ . Since Watts and Strogatz [142] ran at a value of  $ZL$  a factor of 100 larger than ours, our values of  $p$  are a factor of 100 larger to get the same value of  $M = pLZ/2$ . Newman and Watts [99] derive this continuum limit with a renormalization-group analysis (Chapter 12).

(e) *Real networks.* From the book web site [129], or through your own research, find a real network<sup>13</sup> and find the mean distance and histogram of distances between nodes.

<sup>13</sup>Examples include movie-actor costars, ‘Six degrees of Kevin Bacon’, or baseball players who played on the same team.

In the small world network, a few long edges are crucial for efficient transfer through the system (transfer of information in a computer network, transfer of disease in a population model, ...). It is often useful to measure how crucial a given node or edge is to these shortest paths. We say a node or edge is ‘between’ two other nodes if it is along a shortest path between them. We measure the ‘betweenness’ of a node or edge as the total number of such shortest paths passing through it, with (by convention) the initial and final nodes included in the ‘between’ nodes; see Fig. 1.7. (If there are  $K$  multiple shortest paths of equal length between two nodes, each path adds  $1/K$  to its intermediates.) The efficient algorithm to measure betweenness is a depth-first traversal quite analogous to the shortest-path-length algorithm discussed above.



**Fig. 1.7 Betweenness** Small world network with  $L = 500$ ,  $K = 2$ , and  $p = 0.1$ , with node and edge sizes scaled by the square root of their betweenness.

(f) *Betweenness (advanced)*. Read [46, 96], which discuss the algorithms for finding the betweenness. Implement them on the small world network, and perhaps the real world network you analyzed in part (e). Visualize your answers by using the graphics software provided on the book web site [126].

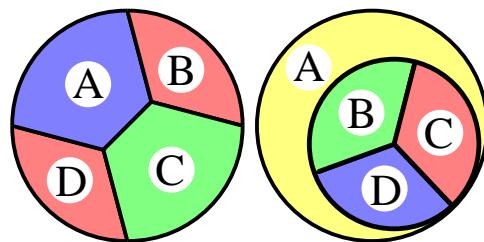
<sup>14</sup>This exercise and the associated software were developed in collaboration with Christopher Myers, with help from Bart Selman and Carla Gomes.

<sup>15</sup>The famous four-color theorem, that any map of countries on the world can be colored in four colors, shows that all planar graphs are 4-colorable.

<sup>16</sup>Because 3-colorability is NP-complete (see Exercise 8.15), finding such a polynomial-time algorithm would allow one to solve traveling salesman problems and find spin-glass ground states in polynomial time too.

(1.8) **Satisfactory map colorings.**<sup>14</sup> (Computer science, Computation, Mathematics) ③

Many problems in computer science involve finding a good answer among a large number of possibilities. One example is *3-colorability* (Fig. 1.8). Can the  $N$  nodes of a graph be colored in three colors (say red, green, and blue) so that no two nodes joined by an edge have the same color?<sup>15</sup> For an  $N$ -node graph one can of course explore the entire ensemble of  $3^N$  colorings, but that takes a time exponential in  $N$ . Sadly, there are no known shortcuts that fundamentally change this; there is no known algorithm for determining whether a given  $N$ -node graph is three-colorable that guarantees an answer in a time that grows only as a power of  $N$ .<sup>16</sup>



**Fig. 1.8 Graph coloring.** Two simple examples of graphs with  $N = 4$  nodes that can and cannot be colored with three colors.

Another good example is *logical satisfiability* (SAT). Suppose one has a long logical expression involving  $N$  boolean variables. The logical expression can use the operations NOT ( $\neg$ ), AND ( $\wedge$ ), and OR ( $\vee$ ). It is *satisfiable* if there is some assignment of *True* and *False* to its variables that makes the expression *True*. Can we solve a general satisfiability problem with  $N$  variables in a worst-case time that grows less quickly than exponentially in  $N$ ? In this exercise, you will show that logical satisfiability is in a sense computationally at least as hard as 3-colorability. That is, you will show that a 3-colorability problem with  $N$  nodes can be mapped onto a logical satisfiability problem with  $3N$  variables, so a polynomial-time (non-exponential) algorithm for the SAT



would imply a (hitherto unknown) polynomial-time solution algorithm for 3-colorability.

If we use the notation  $A_R$  to denote a variable which is true when node  $A$  is colored red, then  $\neg(A_R \wedge A_G)$  is the statement that node  $A$  is not colored both red and green, while  $A_R \vee A_G \vee A_B$  is true if node  $A$  is colored one of the three colors.<sup>17</sup>

There are three types of expressions needed to write the colorability of a graph as a logical satisfiability problem:  $A$  has some color (above),  $A$  has only one color, and  $A$  and a neighbor  $B$  have different colors.

(a) Write out the logical expression that states that  $A$  is colored with only a single color. Write out the logical expression that states that  $A$  and  $B$  are not colored with the same color. Hint: Both should be a conjunction (AND,  $\wedge$ ) of three clauses each involving two variables.

Any logical expression can be rewritten into a standard format, the *conjunctive normal form*. A *literal* is either one of our boolean variables or its negation; a logical expression is in conjunctive normal form if it is a conjunction of a series of clauses, each of which is a disjunction (OR,  $\vee$ ) of literals.

(b) Show that, for two boolean variables  $X$  and  $Y$ , that  $\neg(X \wedge Y)$  is equivalent to a disjunction of literals  $(\neg X) \vee (\neg Y)$ . (Hint: Test each of the four cases). Write your answers to part (a) in conjunctive normal form. What is the maximum number of literals in each clause you used? Is it

the maximum needed for a general 3-colorability problem?

In part (b), you showed that any 3-colorability problem can be mapped onto a logical satisfiability problem in conjunctive normal form with at most three literals in each clause, and with three times the number of boolean variables as there were nodes in the original graph. (Consider this a hint for part (b).) Logical satisfiability problems with at most  $k$  literals per clause in conjunctive normal form are called **kSAT** problems.

(c) Argue that the time needed to translate the 3-colorability problem into a **3SAT** problem grows at most quadratically in the number of nodes  $M$  in the graph (less than  $\alpha M^2$  for some  $\alpha$  for large  $M$ ). (Hint: the number of edges of a graph is at most  $M^2$ .) Given an algorithm that guarantees a solution to any  $N$ -variable **3SAT** problem in a time  $T(N)$ , use it to give a bound on the time needed to solve an  $M$ -node 3-colorability problem. If  $T(N)$  were a polynomial-time algorithm (running in time less than  $N^x$  for some integer  $x$ ), show that 3-colorability would be solvable in a time bounded by a polynomial in  $M$ .

We will return to logical satisfiability, **kSAT**, and **NP**-completeness in Exercise 8.15. There we will study a statistical ensemble of **kSAT** problems, and explore a phase transition in the fraction of satisfiable clauses, and the divergence of the typical computational difficulty near that transition.

<sup>17</sup>The operations AND ( $\wedge$ ) and NOT  $\neg$  correspond to common English usage ( $\wedge$  is true only if both are true,  $\neg$  is true only if the expression following is false). However, OR ( $\vee$ ) is an *inclusive or*—false only if both clauses are false. In common English usage ‘or’ is usually *exclusive*, false also if both are true. (‘Choose door number one or door number two’ normally does not imply that one may select both.)



# Random walks and emergent properties



What makes physics possible? Why are the mathematical laws that describe our macroscopic world so simple? Our physical laws are not direct statements about the underlying reality of the Universe. Rather, our laws emerge out of far more complex microscopic behavior.<sup>1</sup> Statistical mechanics provides a set of powerful tools for understanding simple behavior that emerges from underlying complexity.

In this chapter, we will explore the emergent behavior for *random walks*. Random walks are paths that take successive steps in random directions. They arise often in statistical mechanics: as partial sums of fluctuating quantities, as trajectories of particles undergoing repeated collisions, and as the shapes for long, linked systems like polymers. They introduce two kinds of emergent behavior. First, an individual random walk, after a large number of steps, becomes *fractal* or *scale invariant* (explained in Section 2.1). Secondly, the endpoint of the random walk has a probability distribution that obeys a simple continuum law, the *diffusion equation* (introduced in Section 2.2). Both of these behaviors are largely independent of the microscopic details of the walk; they are *universal*. Random walks in an external field provide our first examples of *conserved currents*, *linear response*, and *Boltzmann distributions* (Section 2.3). Finally we use the diffusion equation to introduce *Fourier* and *Green's function* techniques (Section 2.4). Random walks neatly illustrate many of the themes and methods of statistical mechanics.

## 2.1 Random walk examples: universality and scale invariance

Statistical mechanics often demands sums or averages of a series of fluctuating quantities:  $s_N = \sum_{i=1}^N \ell_i$ . The energy of a material is a sum over the energies of the molecules composing the material; your grade on a statistical mechanics exam is the sum of the scores on many individual questions. Imagine adding up this sum one term at a time. The path  $s_1, s_2, \dots$  forms an example of a one-dimensional random walk. We illustrate random walks with three examples: coin flips, the drunkard's walk, and polymers.

**Coin flips.** For example, consider flipping a coin and recording the difference  $s_N$  between the number of heads and tails found. Each coin

**2.1 Random walk examples: universality and scale invariance**  
15

**2.2 The diffusion equation** 19

**2.3 Currents and external forces**  
20

**2.4 Solving the diffusion equation**  
22

<sup>1</sup>You may think that Newton's law of gravitation, or Einstein's refinement to it, is more fundamental than the diffusion equation. You would be correct; gravitation applies to everything. But the simple macroscopic law of gravitation emerges, presumably, from a quantum exchange of immense numbers of virtual gravitons just as the diffusion equation emerges from large numbers of long random walks. The diffusion equation and other continuum statistical mechanics laws are special to particular systems, but they emerge from the microscopic theory in much the same way as gravitation and the other fundamental laws of nature do. This is the source of many of the surprisingly simple mathematical laws describing nature [145].

flip contributes  $\ell_i = \pm 1$  to the total. How big a sum  $s_N = \sum_{i=1}^N \ell_i =$  (heads – tails) do you expect after  $N$  flips?

The average of  $s_N$  is not a good measure for the sum, because it is zero (positive and negative steps are equally likely). We could measure the average<sup>2</sup> absolute value  $\langle |s_N| \rangle$ , but it turns out that a nicer characteristic distance is the root-mean-square (RMS) of the sum,  $\sqrt{\langle s_N^2 \rangle}$ . After one coin flip, the mean square

$$\langle s_1^2 \rangle = 1 = \frac{1}{2}(-1)^2 + \frac{1}{2}(1)^2; \tag{2.1}$$

and after two and three coin flips

$$\begin{aligned} \langle s_2^2 \rangle &= 2 = \frac{1}{4}(-2)^2 + \frac{1}{2}(0)^2 + \frac{1}{4}(2)^2, \\ \langle s_3^2 \rangle &= 3 = \frac{1}{8}(-3)^2 + \frac{3}{8}(-1)^2 + \frac{3}{8}(1)^2 + \frac{1}{8}(3)^2 \end{aligned} \tag{2.2}$$

(for example, the probability of having two heads in three coin flips is three out of eight, HHT, THT, and TTT). Can you guess what  $\langle s_7^2 \rangle$  will be, without computing it?

Does this pattern continue? We can try writing the RMS after  $N$  steps in terms of the RMS after  $N - 1$  steps, plus the last step. Because the average of the sum is the sum of the average, we find

$$\langle s_N^2 \rangle = \langle (s_{N-1} + \ell_N)^2 \rangle = \langle s_{N-1}^2 \rangle + 2\langle s_{N-1} \ell_N \rangle + \langle \ell_N^2 \rangle. \tag{2.3}$$

Now,  $\ell_N$  is  $\pm 1$  with equal probability, independent of what happened earlier (and thus independent of  $s_{N-1}$ ). Thus  $\langle s_{N-1} \ell_N \rangle = \frac{1}{2}s_{N-1}(+1) + \frac{1}{2}s_{N-1}(-1) = 0$ . We also know that  $\ell_N^2 = 1$ , so

$$\langle s_N^2 \rangle = \langle s_{N-1}^2 \rangle + 2\langle \cancel{s_{N-1} \ell_N} \rangle + \langle \ell_N^2 \rangle = \langle s_{N-1}^2 \rangle + 1. \tag{2.4}$$

If we assume  $\langle s_{N-1}^2 \rangle = N - 1$  we have proved by induction on  $N$  that  $\langle s_N^2 \rangle = N$ .<sup>3</sup>

Hence the square root of the mean square (RMS) of (heads – tails) is equal to the square root of the number of coin flips:

$$\sigma_s = \sqrt{\langle s_N^2 \rangle} = \sqrt{N}. \tag{2.5}$$

**Drunkard’s walk.** Random walks also arise as trajectories that undergo successive random collisions or turns; for example, the trajectory of a perfume molecule in a sample of air<sup>4</sup> (Exercise 2.4). Because the air is dilute and the interactions are short ranged, the molecule will basically travel in straight lines, with sharp changes in velocity during infrequent collisions. After a few substantial collisions, the molecule’s velocity will be uncorrelated with its original velocity. The path taken by the molecule will be a jagged, random walk through three dimensions.

The random walk of a perfume molecule involves random directions, random velocities, and random step sizes. It is more convenient to study steps at regular time intervals, so we will instead consider the classic problem of a drunkard’s walk (Fig. 2.1). The drunkard is presumed to

<sup>2</sup>We use angle brackets  $\langle \cdot \rangle$  to denote averages over ensembles. Here our ensemble contains all  $2^N$  possible sequences of  $N$  coin flips.

<sup>3</sup>The mean of the absolute value  $\langle |s_N| \rangle$  is not nearly as simple to calculate. This is why we generally measure fluctuations by using the mean square, and then taking the square root.

<sup>4</sup>Real perfume in a real room will primarily be transported by convection; in liquids and gases, diffusion dominates usually only on short length scales. Solids do not convect, so thermal or electrical conductivity would be a more accurate—but less vivid—illustration of random walks.

start at a lamp-post at  $x = y = 0$ . He takes steps  $\ell_N$  each of length  $L$ , at regular time intervals. Because he is drunk, the steps are in completely random directions, each uncorrelated with the previous steps. This lack of correlation says that the average dot product between any two steps  $\ell_m$  and  $\ell_n$  is zero, since all relative angles  $\theta$  between the two directions are equally likely:  $\langle \ell_m \cdot \ell_n \rangle = L^2 \langle \cos(\theta) \rangle = 0$ .<sup>5</sup> This implies that the dot product of  $\ell_N$  with  $\mathbf{s}_{N-1} = \sum_{m=1}^{N-1} \ell_m$  is zero. Again, we can use this to work by induction:

$$\begin{aligned} \langle \mathbf{s}_N^2 \rangle &= \langle (\mathbf{s}_{N-1} + \ell_N)^2 \rangle = \langle \mathbf{s}_{N-1}^2 \rangle + \langle 2\mathbf{s}_{N-1} \cdot \ell_N \rangle + \langle \ell_N^2 \rangle \\ &= \langle \mathbf{s}_{N-1}^2 \rangle + L^2 = \dots = NL^2, \end{aligned} \tag{2.6}$$

so the RMS distance moved is  $\sqrt{NL}$ .

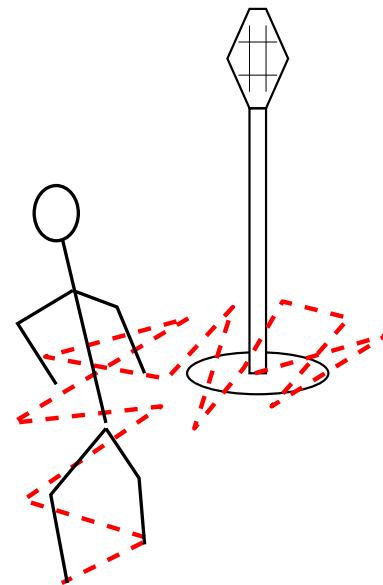
Random walks introduce us to the concepts of *scale invariance* and *universality*.

**Scale invariance.** What kind of path only goes  $\sqrt{N}$  total distance in  $N$  steps? Random walks form paths which look jagged and scrambled. Indeed, they are so jagged that if you blow up a small corner of one, the blown-up version looks just as jagged (Fig. 2.2). Each of the blown-up random walks is different, just as any two random walks of the same length are different, but the ensemble of random walks of length  $N$  looks much like that of length  $N/4$ , until  $N$  becomes small enough that the individual steps can be distinguished. Random walks are *scale invariant*: they look the same on all scales.<sup>6</sup>

**Universality.** On scales where the individual steps are not distinguishable (and any correlations between steps is likewise too small to see) we find that all random walks look the same. Figure 2.2 depicts a drunkard's walk, but any two-dimensional random walk would give the same behavior (statistically). Coin tosses of two coins (penny sums along  $x$ , dime sums along  $y$ ) would produce, statistically, the same random walk ensemble on lengths large compared to the step sizes. In three dimensions, photons<sup>7</sup> in the Sun (Exercise 2.2) or in a glass of milk undergo a random walk with fixed speed  $c$  between collisions. Nonetheless, after a few steps their random walks are statistically indistinguishable from that of our variable-speed perfume molecule. This independence of the behavior on the microscopic details is called *universality*.

Random walks are simple enough that we could show directly that each individual case behaves like the others. In Section 2.2 we will generalize our argument that the RMS distance scales as  $\sqrt{N}$  to simultaneously cover both coin flips and drunkards; with more work we could include variable times between collisions and local correlations to cover the cases of photons and molecules in a gas. We could also calculate properties about the jaggedness of paths in these systems, and show that they too agree with one another after many steps. Instead, we will wait for Chapter 12 (and specifically Exercise 12.11), where we will give a deep but intuitive explanation of why each of these problems is scale invariant, and why all of these problems share the same behavior on long length scales. Universality and scale invariance will be explained there

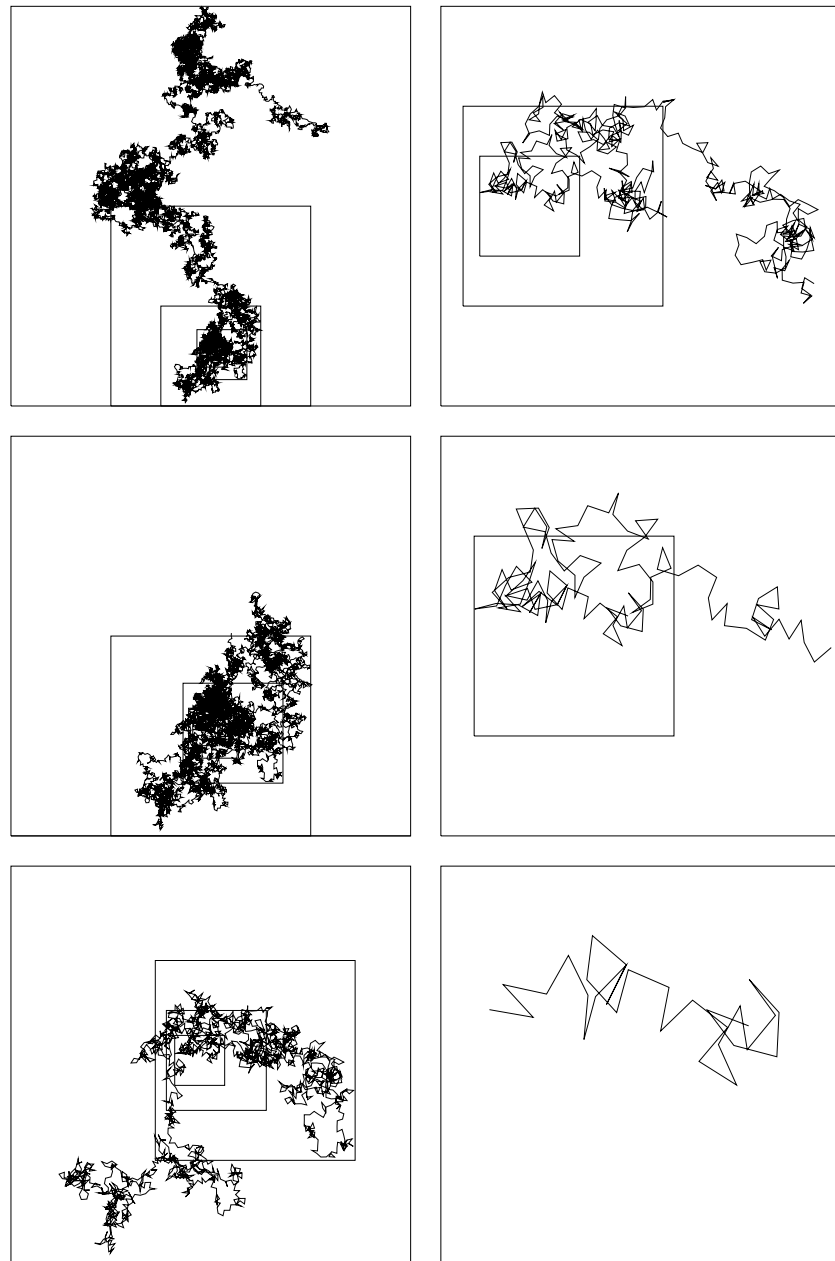
<sup>5</sup>More generally, if two variables are uncorrelated then the average of their product is the product of their averages; in this case this would imply  $\langle \ell_m \cdot \ell_n \rangle = \langle \ell_m \rangle \cdot \langle \ell_n \rangle = \mathbf{0} \cdot \mathbf{0} = 0$ .



**Fig. 2.1 Drunkard's walk.** The drunkard takes a series of steps of length  $L$  away from the lamp-post, but each with a random angle.

<sup>6</sup>They are also fractal with dimension two, in all spatial dimensions larger than two. This just reflects the fact that a random walk of 'volume'  $V = N$  steps roughly fits into a radius  $R \sim s_N \sim N^{1/2}$  (see Fig. 2.2). The fractal dimension  $D$  of the set, defined by  $R^D = V$ , is thus two.

<sup>7</sup>In case you have not heard, a photon is a quantum of light or other electromagnetic radiation.



**Fig. 2.2 Random walk: scale invariance.** Random walks form a jagged, fractal pattern which looks the same when rescaled. Here each succeeding walk is the first quarter of the previous walk, magnified by a factor of two; the shortest random walk is of length 31, the longest of length 32 000 steps. The left side of Fig. 1.1 is the further evolution of this walk to 128 000 steps.

using renormalization-group methods, originally developed to study continuous phase transitions.

**Polymers.** Finally, random walks arise as the shapes for *polymers*. Polymers are long molecules (like DNA, RNA, proteins, and many plastics) made up of many small units (called monomers) attached to one another in a long chain. Temperature can introduce fluctuations in the angle between two adjacent monomers; if these fluctuations dominate over the energy,<sup>8</sup> the polymer shape can form a random walk. Here each step does not increase the time, but rather the number of the monomer along the chain.

The random walks formed by isolated polymers are *not* the same as those in our first two examples; they are in a different *universality class*. This is because the polymer cannot intersect itself; a walk that would cause two monomers to overlap is not allowed. Polymers undergo *self-avoiding* random walks. In two and three dimensions, it turns out that the effects of these self-intersections is not a small, microscopic detail, but changes the properties of the random walk in an essential way.<sup>9</sup> One can show that these forbidden intersections would often arise on far-separated regions of the polymer, and that they change the dependence of squared radius  $\langle s_N^2 \rangle$  on the number of segments  $N$  (Exercise 2.10). In particular, the power law  $\sqrt{\langle s_N^2 \rangle} \sim N^\nu$  changes from the ordinary random walk value  $\nu = 1/2$  to a higher value ( $\nu = 3/4$  in two dimensions and  $\nu \approx 0.59$  in three dimensions [90]). Power laws are central to the study of scale-invariant systems;  $\nu$  is our first example of a *universal critical exponent* (Chapter 12).

## 2.2 The diffusion equation

In the *continuum limit* of long length and time scales, simple behavior emerges from the ensemble of irregular, jagged random walks; their evolution is described by the *diffusion equation*.<sup>10</sup>

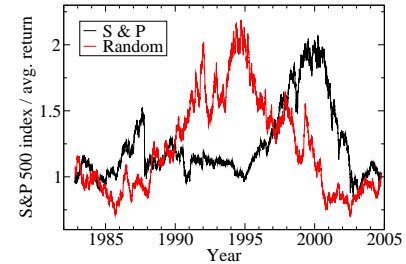
$$\frac{\partial \rho}{\partial t} = D \nabla^2 \rho = D \frac{\partial^2 \rho}{\partial x^2}. \quad (2.7)$$

The diffusion equation can describe the evolving density  $\rho(x, t)$  of a local cloud of perfume as the molecules random walk through collisions with the air molecules. Alternatively, it can describe the probability density of an individual particle as it random walks through space; if the particles are non-interacting, the probability distribution of one particle describes the density of all particles.

In this section, we derive the diffusion equation by taking a continuum limit of the ensemble of random walks. Consider a general, uncorrelated random walk where at each time step  $\Delta t$  the particle's position  $x$  changes by a step  $\ell$ :

$$x(t + \Delta t) = x(t) + \ell(t). \quad (2.8)$$

Let the probability distribution for each step be  $\chi(\ell)$ .<sup>11</sup> We will assume that  $\chi$  has mean zero and standard deviation  $a$ , so the first few



**Fig. 2.3 S&P 500, normalized.** Standard and Poor's 500 stock index daily closing price since its inception, corrected for inflation, divided by the average 6.4% return over this time period. Stock prices are often modeled as a biased random walk (Exercise 2.11). Notice that the fluctuations (risk) in individual stock prices will typically be much higher. By averaging over 500 stocks, the random fluctuations in this index are reduced, while the average return remains the same; see [85, 86]. For comparison, a one-dimensional multiplicative random walk is also shown.

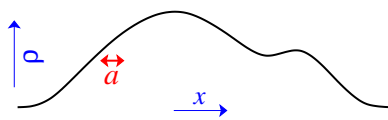
<sup>8</sup>Polymers do not always form random walks. Polymeric plastics at low temperature can form crystals; functional proteins and RNA often pack tightly into well-defined shapes. Molten plastics and denatured proteins, though, do form self-avoiding random walks. Double-stranded DNA is rather stiff; the step size for the random walk of DNA in solution is many nucleic acids long (Exercise 2.10).

<sup>9</sup>Self-avoidance is said to be a *relevant* perturbation that changes the universality class. In (unphysical) spatial dimensions higher than four, self-avoidance is irrelevant; hypothetical hyper-polymers in five dimensions would look like regular random walks on long length scales.

<sup>10</sup>In the remainder of this chapter we specialize for simplicity to one dimension. We also change variables from the sum  $s$  to position  $x$ .

<sup>11</sup>In our two examples the distribution  $\chi(\ell)$  is discrete; we can write it using the Dirac  $\delta$ -function (note 4 on p. 6). For coin flips,  $\chi(\ell) = \frac{1}{2}\delta(\ell + 1) + \frac{1}{2}\delta(\ell - 1)$ ; for the drunkard,  $\chi(\ell) = \delta(|\ell| - L)/(2\pi L)$ , evenly spaced around the circle.

<sup>12</sup>The  $n$ th moment of a function  $\rho(x)$  is defined to be  $\langle x^n \rangle = \int x^n \rho(x) dx$ .



**Fig. 2.4 Continuum limit for random walks.** We suppose the typical step sizes  $a$  are small compared to the broad ranges on which  $\rho(x)$  varies, so we may do a Taylor expansion in gradients of  $\rho$ .

<sup>13</sup>Notice that although  $dz = -dx'$ , the limits of integration  $\int_{-\infty}^{\infty} \rightarrow \int_{\infty}^{-\infty} = -\int_{-\infty}^{\infty}$ , canceling the minus sign. This happens often in calculations; watch out for it.

<sup>14</sup> $D$  must be greater than zero. Random walks and diffusion tend to even out the hills and valleys in the density. Hills have negative second derivatives ( $\partial^2 \rho / \partial x^2 < 0$ ) and should flatten ( $\partial \rho / \partial t < 0$ ), valleys have positive second derivatives and fill up.

<sup>15</sup>Something is locally conserved if its integral (zeroth moment) is independent of time, and if the substance only moves continuously from one place to another (no ‘teleportation’ allowed). For example, the probability density  $\rho(x)$  of a single particle undergoing a random walk is also conserved; like particle density, probability cannot be created or destroyed, it can only ‘slosh around’.

moments<sup>12</sup> of  $\chi$  are

$$\begin{aligned} \int \chi(z) dz &= 1, \\ \int z\chi(z) dz &= 0, \\ \int z^2\chi(z) dz &= a^2. \end{aligned} \tag{2.9}$$

What is the probability distribution  $\rho(x, t + \Delta t)$  at the next time step, given the probability distribution  $\rho(x', t)$ ?

For the particle to go from  $x'$  at time  $t$  to  $x$  at time  $t + \Delta t$ , the step  $\ell(t)$  must be  $x - x'$ . This happens with probability  $\chi(x - x')$  times the probability density  $\rho(x', t)$  that it started at  $x'$ . Integrating over original positions  $x'$ , we have

$$\begin{aligned} \rho(x, t + \Delta t) &= \int_{-\infty}^{\infty} \rho(x', t)\chi(x - x') dx' \\ &= \int_{-\infty}^{\infty} \rho(x - z, t)\chi(z) dz, \end{aligned} \tag{2.10}$$

where we change variables to  $z = x - x'$ .<sup>13</sup>

Now, suppose  $\rho$  is broad; the step size is very small compared to the scales on which  $\rho$  varies (Fig. 2.4). We may then do a Taylor expansion of eqn 2.10 in  $z$ :

$$\begin{aligned} \rho(x, t + \Delta t) &\approx \int \left[ \rho(x, t) - z \frac{\partial \rho}{\partial x} + \frac{z^2}{2} \frac{\partial^2 \rho}{\partial x^2} \right] \chi(z) dz \\ &= \rho(x, t) \int \chi(z) dz - \frac{\partial \rho}{\partial x} \int z\chi(z) dz + \frac{1}{2} \frac{\partial^2 \rho}{\partial x^2} \int z^2\chi(z) dz \\ &= \rho(x, t) + \frac{1}{2} \frac{\partial^2 \rho}{\partial x^2} a^2, \end{aligned} \tag{2.11}$$

using the moments of  $\chi$  in eqn 2.9. Now, if we also assume that  $\rho$  is slow, so that it changes only slightly during this time step, we can approximate  $\rho(x, t + \Delta t) - \rho(x, t) \approx (\partial \rho / \partial t) \Delta t$ , and we find

$$\frac{\partial \rho}{\partial t} = \frac{a^2}{2\Delta t} \frac{\partial^2 \rho}{\partial x^2}. \tag{2.12}$$

This is the diffusion equation<sup>14</sup> (eqn 2.7), with

$$D = a^2 / 2\Delta t. \tag{2.13}$$

The diffusion equation applies to all random walks, so long as the probability distribution is broad and slowly varying compared to the size and time of the individual steps.

### 2.3 Currents and external forces

As the particles in our random walks move around, they are never created or destroyed; they are *locally conserved*.<sup>15</sup> If  $\rho(x)$  is the density of



a conserved quantity, we may write its evolution law (see Fig. 2.5) in terms of the current  $J(x)$  passing a given point  $x$ :

$$\frac{\partial \rho}{\partial t} = -\frac{\partial J}{\partial x}. \tag{2.14}$$

Here the current  $J$  is the rate at which ‘stuff’ flows to the right through the point  $x$ ; since the ‘stuff’ is conserved, the only way the density can change is by flowing from one place to another. The diffusion eqn 2.7 results from current conservation (eqn 2.14) and a current<sup>16</sup> that is proportional to the local gradient in the density:

$$J_{\text{diffusion}} = -D \frac{\partial \rho}{\partial x}, \tag{2.15}$$

as we would expect in general from linear response.<sup>17</sup> Particles diffuse (random walk) on average from regions of high density toward regions of low density.

In many applications one has an average drift term along with a random walk. In some cases (like the total grade in a multiple-choice test, Exercise 2.1) there is naturally a non-zero mean for each step in the random walk. In other cases, there is an external force  $F$  that is biasing the steps to one side; the mean net drift is  $F \Delta t$  times a mobility  $\gamma$ :

$$x(t + \Delta t) = x(t) + F\gamma\Delta t + \ell(t). \tag{2.16}$$

We can derive formulæ for this mobility given a microscopic model. On the one hand, if our air is dense and the diffusing molecule is large, we might treat the air as a viscous fluid of dynamical viscosity  $\eta$ ; if we also simply model the molecule as a sphere of radius  $r$ , a fluid mechanics calculation tells us that the mobility is  $\gamma = 1/(6\pi\eta r)$ . On the other hand, if our air is dilute and the diffusing molecule is small, we can model the trajectory as free acceleration between collisions separated by equal times  $\Delta t$ , and we can assume that the collisions completely scramble the sign of the initial velocity  $v_0$ .<sup>18</sup> In this case, the net motion due to the external force is half the acceleration  $F/m$  times the time squared:  $\frac{1}{2}(F/m)(\Delta t)^2 = F \Delta t(\Delta t/2m)$  so  $\gamma = (\Delta t/2m)$  Using eqn 2.13, we find

$$\gamma = \frac{\Delta t}{2m} \left( D \frac{2\Delta t}{a^2} \right) = \frac{D}{m(a/\Delta t)^2} = \frac{D}{mv_0^2}, \tag{2.17}$$

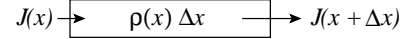
where  $a = v_0\Delta t$  is the size of the unbiased random-walk step.

Starting from eqn 2.16, we can repeat our analysis of the continuum limit (eqns 2.10–2.12) to derive the diffusion equation in an external force:<sup>19</sup>

$$\frac{\partial \rho}{\partial t} = -\gamma F \frac{\partial \rho}{\partial x} + D \frac{\partial^2 \rho}{\partial x^2}, \tag{2.18}$$

which follows from the current

$$J = \gamma F \rho - D \frac{\partial \rho}{\partial x}. \tag{2.19}$$



**Fig. 2.5 Conserved current.** Let  $\rho(x, t)$  be the density of some conserved quantity (number of molecules, mass, energy, probability, etc.) varying in one spatial dimension  $x$ , and  $J(x)$  be the net rate at which the quantity is passing to the right through a point  $x$ . The amount of ‘stuff’ in a small region  $(x, x + \Delta x)$  is  $n = \rho(x) \Delta x$ . The flow of particles into this region from the left is  $J(x)$  and the flow out is  $J(x + \Delta x)$ , so

$$\frac{\partial n}{\partial t} = J(x) - J(x + \Delta x) \approx \frac{\partial \rho}{\partial t} \Delta x,$$

and we derive the conserved current relation:

$$\frac{\partial \rho}{\partial t} = -\frac{J(x + \Delta x) - J(x)}{\Delta x} = -\frac{\partial J}{\partial x}.$$

<sup>16</sup>The diffusion equation implies a current  $J = -D \partial \rho / \partial x + C$ , but a constant background current  $C$  independent of  $\rho$  is not physical for random walks.

<sup>17</sup>See note 43 on page 122.

<sup>18</sup>More realistic models have a distribution of velocities and step sizes.

<sup>19</sup>Warning: If the force is not constant in space, the evolution also depends on the gradient of the force:

$$\begin{aligned} \frac{\partial \rho}{\partial t} &= -\frac{\partial J}{\partial x} = -\gamma \frac{\partial F(x)\rho(x)}{\partial x} + D \frac{\partial^2 \rho}{\partial x^2} \\ &= -\gamma \rho \frac{\partial F}{\partial x} - \gamma F \frac{\partial \rho}{\partial x} + D \frac{\partial^2 \rho}{\partial x^2}. \end{aligned}$$

Similar problems can arise if the diffusion constant depends on space or density. When working with a conserved property, write your equations first in terms of the current, to guarantee that it is conserved:  $J = -D(\rho, \mathbf{x})\nabla\rho + \gamma(\mathbf{x})F(\mathbf{x})\rho(\mathbf{x})$ . The author has observed himself and several graduate students wasting up to a week at a time when this rule is forgotten.

The sign of the new term can be explained intuitively: if  $\rho$  is increasing in space (positive slope  $\partial\rho/\partial x$ ) and the force is dragging the particles forward ( $F > 0$ ), then  $\rho$  will decrease with time because the high-density regions ahead of  $x$  are receding and the low-density regions behind  $x$  are moving in.

The diffusion equation describes how systems of random-walking particles approach equilibrium (see Chapter 3). The diffusion equation in the absence of an external force describes the evolution of perfume density in a room. A time-independent equilibrium state  $\rho^*$  obeying the diffusion eqn 2.7 must have  $\partial^2\rho^*/\partial x^2 = 0$ , so  $\rho^*(x) = \rho_0 + Bx$ . If the perfume cannot penetrate the walls,  $\partial\rho^*/\partial x \propto J = 0$  at the boundaries, so  $B = 0$ . Thus, as one might expect, the perfume evolves to a rather featureless equilibrium state  $\rho^*(x) = \rho_0$ , evenly distributed throughout the room.

In the presence of a constant external force (like gravitation) the equilibrium state is more interesting. Let  $x$  be the height above the ground, and  $F = -mg$  be the force due to gravity. By eqn 2.18, the equilibrium state  $\rho^*$  satisfies

$$0 = \frac{\partial\rho^*}{\partial t} = \gamma mg \frac{\partial\rho^*}{\partial x} + D \frac{\partial^2\rho^*}{\partial x^2}, \quad (2.20)$$

which has general solution  $\rho^*(x) = A \exp[-(\gamma/D)mgx] + B$ . We assume that the density of perfume  $B$  in outer space is zero,<sup>20</sup> so the density of perfume decreases exponentially with height:

$$\rho^*(x) = A \exp\left(-\frac{\gamma}{D}mgx\right). \quad (2.21)$$

The perfume molecules are pulled downward by the gravitational force, and remain aloft only because of the random walk. If we generalize from perfume to oxygen molecules (and ignore temperature gradients and weather) this gives the basic explanation for why it becomes harder to breathe as one climbs mountains.<sup>21</sup>

## 2.4 Solving the diffusion equation

We take a brief mathematical interlude, to review two important methods for solving the diffusion equation: Fourier transforms and Green's functions. Both rely upon the fact that the diffusion equation is linear; if a family of solutions  $\rho_n(x, t)$  are known, then any linear combination of these solutions  $\sum_n a_n \rho_n(x, t)$  is also a solution. If we can then expand the initial density  $\rho(x, 0) = \sum_n a_n \rho_n(x, 0)$ , we have formally found the solution.

Fourier methods are wonderfully effective computationally, because of fast Fourier transform (FFT) algorithms for shifting from the real-space density to the solution space. Green's function methods are more important for analytical calculations and as a source of approximate solutions.<sup>22</sup>

<sup>20</sup>Non-zero  $B$  would correspond to a constant-density rain of perfume.

<sup>21</sup>In Chapter 6 we shall derive the Boltzmann distribution, implying that the probability of having energy  $mgh = E$  in an equilibrium system is proportional to  $\exp(-E/k_B T)$ , where  $T$  is the temperature and  $k_B$  is Boltzmann's constant. This has just the same form as our solution (eqn 2.21), if

$$D/\gamma = k_B T. \quad (2.22)$$

This is called the *Einstein relation*. The constants  $D$  and  $\gamma$  in the (non-equilibrium) diffusion equation are related to one another, because the density must evolve toward the equilibrium distribution dictated by statistical mechanics. Our rough derivation (eqn 2.17) also suggested that  $D/\gamma = mv^2$ , which with eqn 2.22 suggests that  $k_B T$  must equal twice the mean kinetic energy along  $x$ ; this is also true, and is called the *equipartition theorem* (Section 3.2.2).

<sup>22</sup>One should note that much of quantum field theory and many-body quantum mechanics is framed in terms of things also called Green's functions. These are distant, fancier cousins of the simple methods used in linear differential equations (see Exercise 10.9).

### 2.4.1 Fourier

The Fourier transform method decomposes  $\rho$  into a family of *plane wave* solutions  $\tilde{\rho}_k(t)e^{ikx}$ .

The diffusion equation is homogeneous in space; our system is *translationally invariant*. That is, if we have a solution  $\rho(x, t)$ , another equally valid solution is given by  $\rho(x - \Delta, t)$ , which describes the evolution of an initial condition translated by  $\Delta$  in the positive  $x$  direction.<sup>23</sup> Under very general circumstances, a linear differential equation describing a translation-invariant system will have solutions given by plane waves  $\rho(x, t) = \tilde{\rho}_k(t)e^{ikx}$ .

We argue this important truth in detail in the Appendix (Section A.4). Here we just try it. Plugging a plane wave<sup>24</sup> into the diffusion eqn 2.7, we find

$$\frac{\partial \rho}{\partial t} = \frac{d\tilde{\rho}_k}{dt}e^{ikx} = D \frac{\partial^2 \rho}{\partial x^2} = -Dk^2 \tilde{\rho}_k e^{ikx}, \quad (2.23)$$

$$\frac{d\tilde{\rho}_k}{dt} = -Dk^2 \tilde{\rho}_k, \quad (2.24)$$

$$\tilde{\rho}_k(t) = \tilde{\rho}_k(0)e^{-Dk^2 t}. \quad (2.25)$$

Now, these plane wave solutions by themselves are unphysical; we must combine them to get a sensible density. First, they are complex; we must add plane waves at  $k$  and  $-k$  to form cosine waves, or subtract them and divide by  $2i$  to get sine waves. Cosines and sines are also not by themselves densities (because they go negative), but they in turn can be added to one another (for example, added to a  $k = 0$  constant background  $\rho_0$ ) to make for sensible densities. Indeed, we can superimpose all different wavevectors to get the general solution

$$\rho(x, t) = \frac{1}{2\pi} \int_{-\infty}^{\infty} \tilde{\rho}_k(0)e^{ikx}e^{-Dk^2 t} dk. \quad (2.26)$$

Here the coefficients  $\rho_k(0)$  we use are just the Fourier transform of the initial density profile (eqn A.9):

$$\tilde{\rho}_k(0) = \int_{-\infty}^{\infty} \rho(x, 0)e^{-ikx} dx, \quad (2.27)$$

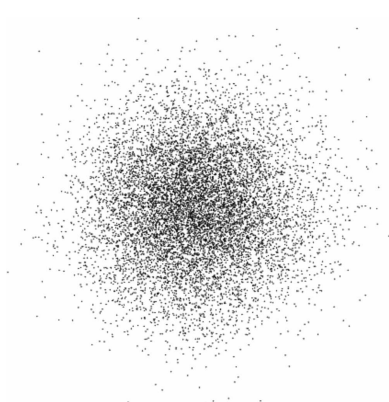
and we recognize eqn 2.26 as the inverse Fourier transform (eqn A.10) of the solution time evolved in Fourier space (eqn 2.25). Thus, by writing  $\rho$  as a superposition of plane waves, we find a simple law: the short-wavelength parts of  $\rho$  are ‘squelched’ as time  $t$  evolves, with wavevector  $k$  being suppressed by a factor  $e^{-Dk^2 t}$ .

### 2.4.2 Green

The Green’s function method decomposes  $\rho$  into a family of solutions  $G(x - y, t)$  where  $G$  describes the evolution of an initial state concentrated at one point, here representing the diffusing particles all starting at a particular point  $y$ .

<sup>23</sup>Make sure you know that  $g(x) = f(x - \Delta)$  shifts the function in the positive direction; for example, the new function  $g(\Delta)$  is at  $\Delta$  what the old one was at the origin,  $g(\Delta) = f(0)$ .

<sup>24</sup>Many readers will recognize this method of calculation from wave equations or Schrödinger’s equation. Indeed, Schrödinger’s equation in free space is the diffusion equation with an imaginary diffusion constant.



**Fig. 2.6 Many random walks.** 10 000 endpoints of random walks, each 1000 steps long. Notice that after 1000 steps, the distribution of endpoints looks quite Gaussian. Indeed after about five steps the distribution is extraordinarily close to Gaussian, except far in the tails.

<sup>25</sup>Physicists call  $\exp(-x^2)$  a Gaussian. In statistics, the corresponding probability distribution  $(1/\sqrt{2\pi}) \exp(-x^2/2)$  is called a *normal distribution*. It is useful to remember that the Fourier transform of a normalized Gaussian  $(1/\sqrt{2\pi}\sigma) \exp(-x^2/2\sigma^2)$  is another Gaussian,  $\exp(-\sigma^2 k^2/2)$  of standard deviation  $1/\sigma$  and with no prefactor (eqn 2.32).

<sup>26</sup>Take the exponent  $ikx - Dk^2t$  in eqn 2.30 and complete the square to  $-Dt(k - ix/(2Dt))^2 - x^2/(4Dt)$ , and then change variables to  $\kappa = k - ix/(2Dt)$ :

$$G(x, t) = \frac{1}{2\pi} e^{-\frac{x^2}{4Dt}} \int_{-\infty - ix/(2Dt)}^{\infty - ix/(2Dt)} e^{-Dt\kappa^2} d\kappa. \tag{2.31}$$

If we could shift the limits of integration downward to the real axis, the integral would give  $\sqrt{\pi/Dt}$ , yielding a derivation of eqn 2.32. This last step (shifting the limits of integration), is not obvious; we must rely on Cauchy's theorem, which allows one to deform the integration contour in the complex plane (Fig. 10.11 in Section 10.9). This is done backward (real to Fourier space) in note 23, Exercise A.4.

Let us first consider the case where all particles start at the origin. Suppose we have one unit of perfume, released at the origin at time  $t = 0$ . What is the initial condition  $\rho(x, t = 0)$ ? It is zero except at  $x = 0$ , but the integral  $\int \rho(x, 0) dx = 1$ , so  $\rho(0, 0)$  must be really, really infinite. This is the Dirac delta-function  $\delta(x)$  (see note 4 on page 6) which mathematically (when integrated) is a linear operator on functions returning the value of the function at zero:

$$\int f(y)\delta(y) dy = f(0). \tag{2.28}$$

Let us define the Green's function  $G(x, t)$  to be the time evolution of the density  $G(x, 0) = \delta(x)$  with all the perfume at the origin. Naturally,  $G(x, t)$  obeys the diffusion equation  $\partial G/\partial t = D\partial^2 G/\partial x^2$ . We can use the Fourier transform methods of the previous section to solve for  $G(x, t)$ . The Fourier transform at  $t = 0$  is

$$\tilde{G}_k(0) = \int G(x, 0)e^{-ikx} dx = \int \delta(x)e^{-ikx} dx = 1 \tag{2.29}$$

(independent of  $k$ ). Hence the time-evolved Fourier transform is  $\tilde{G}_k(t) = e^{-Dk^2t}$ , and the time evolution in real space is

$$G(x, t) = \frac{1}{2\pi} \int e^{ikx} \tilde{G}_k(0)e^{-Dk^2t} dk = \frac{1}{2\pi} \int e^{ikx} e^{-Dk^2t} dk. \tag{2.30}$$

This last integral is the inverse Fourier transform of a Gaussian,<sup>25</sup> which can be performed<sup>26</sup> giving another Gaussian

$$G(x, t) = \frac{1}{\sqrt{4\pi Dt}} e^{-x^2/4Dt}. \tag{2.32}$$

This is the Green's function for the diffusion equation. The Green's function directly tells us the distribution of the endpoints of random walks centered at the origin (Fig. 2.6).

- The Green's function gives us the whole probability distribution of distances. For an  $N$ -step random walk of step size  $a$ , we saw in Section 2.1 that  $\sqrt{\langle x^2 \rangle} = \sqrt{N}a$ ; does this also follow from our Green's function? At time  $t$ , the Green's function (eqn 2.32) is a Gaussian with standard deviation  $\sigma(t) = \sqrt{2Dt}$ ; substituting in our diffusion constant  $D = a^2/2\Delta t$  (eqn 2.13), we find an RMS distance of  $\sigma(t) = a\sqrt{t/\Delta t} = a\sqrt{N}$ , where  $N = t/\Delta t$  is the number of steps taken in the random walk; our two methods do agree.
- Finally, since the diffusion equation has translational symmetry, we can solve for the evolution of random walks centered at any point  $y$ ; the time evolution of an initial condition  $\delta(x - y)$  is  $G(x - y, t)$ . Since we can write any initial condition  $\rho(x, 0)$  as a superposition of  $\delta$ -functions:

$$\rho(x, 0) = \int \rho(y, 0)\delta(x - y) dy = \int \rho(y, 0)G(x - y, 0) dy, \tag{2.33}$$

we can write a general solution  $\rho(x, t)$  to the diffusion equation:

$$\begin{aligned}\rho(x, t) &= \int \rho(y, 0)G(x - y, t) dy \\ &= \int \rho(y, 0) \exp(-(x - y)^2/4Dt)/\sqrt{4\pi Dt} dy.\end{aligned}\quad (2.34)$$

This equation states that the current value of the density is given by the original values of the density in the neighborhood, smeared sideways (convolved) with the function  $G$ . Thus by writing  $\rho$  as a superposition of point sources, we find that the diffusion equation smears out all the sharp features in the initial condition. The distribution after time  $t$  is the initial distribution averaged over a range given by the typical random walk distance  $\sqrt{2Dt}$ .

Equation 2.32 is the *central limit theorem*: the sum of many independent random variables has a probability distribution that converges to a Gaussian.<sup>27</sup>

<sup>27</sup> This is presumably why statisticians call the Gaussian a normal distribution, since under normal circumstances a sum or average of many measurements will have fluctuations described by a Gaussian.

---

## Exercises

*Random walks in grade space*, *Photon diffusion in the Sun*, and *Molecular motors* describe random walks in diverse contexts. *Perfume walk* explores the atomic trajectories in molecular dynamics. *Generating random walks* numerically explores emergent symmetries and the central limit theorem for random walks. *Fourier and Green* and *Periodic diffusion* illustrate the qualitative behavior of the Fourier and Green's function approaches to solving the diffusion equation. *Thermal diffusion* and *Frying pan* derive the diffusion equation for thermal conductivity, and apply it to a practical problem in culinary physics. *Polymers and random walks* explores self-avoiding random walks; in two dimensions, we find that the constraint that the walk must avoid itself gives new critical exponents and a new universality class (see also Chapter 12).

*Stocks, volatility, and diversification* quantifies the fluctuations in the stock-market, and explains why diversification lowers your risk without changing your mean asset growth. *Computational finance: pricing derivatives* focuses on a single step of a random walk in stock prices, to estimate the value of stock option. Finally, *Building a percolation network* introduces another ensemble (percolating networks) that, like random walks, exhibits self-similarity and power-law scaling; we will study the (much more subtle) continuum limit for percolation in Chapter 12 and Exercise 12.12.

Random walks arise in many contexts; post-publication

exercises on two subjects are planned for the book website [126]. (i) Bacteria search for food (*chemotaxis*) using a biased random walk, randomly switching from a swimming state (random walk step) to a tumbling state (scrambling the velocity), see [16]. (ii) Random walks with infrequent, very long steps can form a different universality class, called *Levy flights*, which are not described by the diffusion equation and do not obey the central limit theorem.

### (2.1) Random walks in grade space. ②

Let us make a model of the grade distribution in an exam. Let us imagine a multiple-choice test of ten problems of ten points each. Each problem is identically difficult, and the mean is 70. How much of the point spread on the exam is just luck, and how much reflects the differences in skill and knowledge of the people taking the exam? To test this, let us imagine that all students are identical, and that each question is answered at random with a probability 0.7 of getting it right.

(a) *What is the expected mean and standard deviation for the exam? (Work it out for one question, and then use our theorems for a random walk with ten steps.)*

A typical exam with a mean of 70 might have a standard deviation of about 15.

(b) *What physical interpretation do you make of the ratio of the random standard deviation and the observed one?*

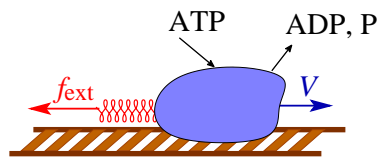
(2.2) **Photon diffusion in the Sun.** (Astrophysics) ②

Most of the fusion energy generated by the Sun is produced near its center. The Sun is  $7 \times 10^5$  km in radius. Convection probably dominates heat transport in approximately the outer third of the Sun, but it is believed that energy is transported through the inner portions (say to a radius  $R = 5 \times 10^8$  m) through a random walk of X-ray photons. (A photon is a quantized package of energy; you may view it as a particle which always moves at the speed of light  $c$ . Ignore for this exercise the index of refraction of the Sun.) Assume that the mean free path  $\ell$  for the photon is  $\ell = 5 \times 10^{-5}$  m.

*About how many random steps  $N$  will the photon take of length  $\ell$  to get to the radius  $R$  where convection becomes important? About how many years  $\Delta t$  will it take for the photon to get there? (You may assume for this exercise that the photon takes steps in random directions, each of equal length given by the mean free path.)* Related formulae:  $c = 3 \times 10^8$  m/s;  $\langle x^2 \rangle \sim 2Dt$ ;  $\langle s_n^2 \rangle = n\sigma^2 = n\langle s_1^2 \rangle$ .

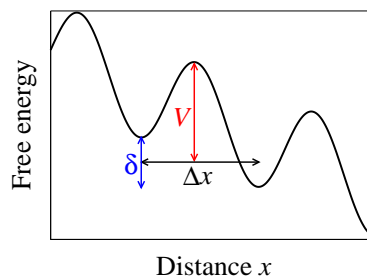
There are  $31\,556\,925.9747 \sim \pi \times 10^7 \sim 3 \times 10^7$  s in a year.

(2.3) **Molecular motors and random walks.**<sup>28</sup> (Biology) ②



**Fig. 2.7 Motor protein.** As it carries some cargo along the way (or builds an RNA or protein, ...) it moves against an external force  $f_{\text{ext}}$  and consumes ATP molecules, which are hydrolyzed to ADP and phosphate (P).

Inside your cells, there are several different molecular motors, which move and pull and copy (Fig. 2.7). There are molecular motors which contract your muscles, there are motors which copy (*transcribe*) your DNA into RNA and copy (*translate*) your RNA into protein, there are motors which transport biomolecules around in the cell. All of these motors share some common features: (1) they move along some linear track (microtubule, DNA, ...), hopping forward in discrete jumps between low-energy positions; (2) they consume energy (burning ATP or NTP) as they move, generating an effective force pushing them forward; and (3) their mechanical properties can be studied by seeing how their motion changes as the external force on them is changed.



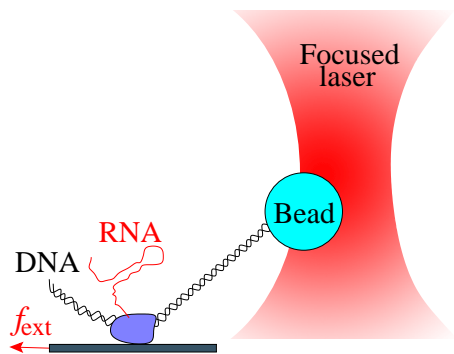
**Fig. 2.8 Effective potential for moving along DNA.** The energy (or rather the Gibbs free energy) for the molecular motor as a function of distance along the DNA. The motor is in a low-energy state just after it transcribes one nucleotide into RNA. The energy barrier  $V$  needs to be crossed in order to transcribe the next nucleotide. The energy asymmetry  $\delta$  is a sum of contributions from the bonding of the RNA nucleotide, the burning of ATP, and the detachment of the apparatus at the completed end. The experiment changes this asymmetry by adding an external force tilting the potential to the left, retarding the transcription.

For transcription of DNA into RNA, the motor moves on average one base pair (A, T, G, or C) per step;  $\Delta x$  is about 0.34 nm. The motor must cross an asymmetric energy barrier as it attaches another nucleotide to the RNA (Fig. 2.8). Wang and co-authors (Fig. 2.9) showed that the motor stalls at an external force of about 27 pN (pico-Newton).

(a) *At that force, what is the energy difference between neighboring wells due to the external force*

<sup>28</sup>This exercise was developed with the assistance of Michelle Wang.

from the bead? Let us assume that this stall force is what is needed to balance the natural force downhill that the motor develops to propel the transcription process. What does this imply about the ratio of the forward rate to the backward rate, in the absence of the external force from the laser tweezers, at a temperature of 300 K? ( $k_B = 1.381 \times 10^{-23}$  J/K.) (Hints: If the population was in thermal equilibrium the net flux would be equal going forward and backward, the net flux out of a well is the population in that well times the rate, and a given motor does not know whether it is part of an equilibrium ensemble.)



**Fig. 2.9 Laser tweezer experiment.** The laser beam is focused at a point (the *laser trap*); the polystyrene bead is pulled (from dielectric effects) into the intense part of the light beam. The *track* is a DNA molecule attached to the bead, the motor is an RNA polymerase molecule, and the force is applied by a glass cover slip to which the motor is attached. As the motor copies DNA onto RNA, it pulls the DNA track toward itself, dragging the bead out of the trap, generating a force resisting the motion.

The natural force downhill is coming from the chemical reactions which accompany the motor moving one base pair; the motor burns up an NTP molecule into a  $PP_i$  molecule, and attaches a nucleotide onto the RNA. The net energy from this reaction depends on details, but varies between about 2 and 5 times  $10^{-20}$  J. This is actu-

ally a Gibbs free energy difference, but for this exercise treat it as just an energy difference.

(b) The motor is not perfectly efficient; not all the chemical energy is available as motor force. From your answer to part (a), give the efficiency of the motor as the ratio of force-times-distance produced to energy consumed, for the range of consumed energies given.

Many of the models for these motors are based on Feynman's *Ratchet and pawl* discussion [41, I.46], where he (presciently) speculates about how gears and ratchets would work on a molecular level.

#### (2.4) Perfume walk.<sup>29</sup> (Computation) ②

The trajectory of a perfume molecule in still air, or more generally any molecule in a dilute gas, is a chaotic path of nearly straight segments followed by collisions—a random walk. You may download our molecular dynamics software [10] from the text web site [129].

Run a simulation of an interacting dilute gas, setting the average velocity of the atoms to zero.<sup>30</sup> Watch the motion of a single 'perfume' atom. Notice that as it passes the edge of the container, it reappears at the opposite face; this simulation uses *periodic boundary conditions*.<sup>31</sup> Your software should have options to plot and analyze the trajectory  $\mathbf{r}_u = (x_u, y_u, z_u)$  of a given atom 'unfolded' into a continuous path which ignores the periodic boundary conditions. (a) Does the trajectory of the perfume atom appear qualitatively like a random walk? Plot  $x_u(t)$  versus  $t$ , and  $x_u(t)$  versus  $y_u(t)$ . The time it takes the atom to completely change direction (lose memory of its original velocity) is the collision time, and the distance it takes is the collision length. Crudely estimate these.

(b) Plot  $\mathbf{r}_u^2(t)$  versus  $t$ , for several individual particles (making sure the average velocity is zero). Do they individually grow with time in a regular fashion? Plot  $\langle \mathbf{r}_u^2 \rangle$  versus  $t$ , averaged over all particles in your simulation. Does it grow linearly with time? Estimate the diffusion constant  $D$ .

<sup>29</sup>This exercise and the associated software were developed in collaboration with Christopher Myers.

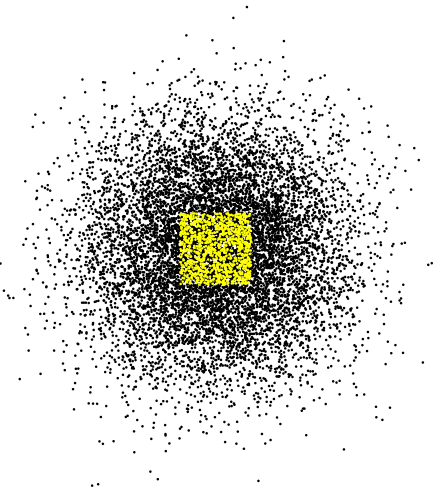
<sup>30</sup>The atoms interact via a Lennard–Jones pair potential, which is a good approximation for the forces between noble gas molecules like argon.

<sup>31</sup>Periodic boundary conditions are an artificial method which allows a small simulation to mimic infinite space, by mathematically identifying the opposite faces of a square region;  $(x, y, z) \equiv (x \pm L, y, z) \equiv (x, y \pm L, z) \equiv (x, y, z \pm L)$ .

(2.5) **Generating random walks.**<sup>32</sup> (Computation) ③

One can efficiently generate and analyze random walks on the computer.

(a) Write a routine to generate an  $N$ -step random walk in  $d$  dimensions, with each step uniformly distributed in the range  $(-1/2, 1/2)$  in each dimension. (Generate the steps first as an  $N \times d$  array, then do a cumulative sum.) Plot  $x_t$  versus  $t$  for a few 10 000-step random walks. Plot  $x$  versus  $y$  for a few two-dimensional random walks, with  $N = 10, 1000,$  and  $100\,000$ . (Try to keep the aspect ratio of the  $XY$  plot equal to one.) Does multiplying the number of steps by one hundred roughly increase the net distance by ten?



**Fig. 2.10 Emergent rotational symmetry.** Endpoints of many random walks, with one step (central square of bright dots) and ten steps (surrounding pattern). Even though the individual steps in a random walk break rotational symmetry (the steps are longer along the diagonals), multi-step random walks are spherically symmetric. The rotational symmetry emerges as the number of steps grows.

Each random walk is different and unpredictable, but the ensemble of random walks has elegant, predictable properties.

(b) Write a routine to calculate the endpoints of  $W$  random walks with  $N$  steps each in  $d$  dimensions. Do a scatter plot of the endpoints of 10 000 random walks with  $N = 1$  and 10, superimposed on the same plot. Notice that the

longer random walks are distributed in a circularly symmetric pattern, even though the single step random walk  $N = 1$  has a square probability distribution (Fig. 2.10).

This is an emergent symmetry; even though the walker steps longer distances along the diagonals of a square, a random walk several steps long has nearly perfect rotational symmetry.<sup>33</sup>

The most useful property of random walks is the central limit theorem. The endpoints of an ensemble of  $N$  step one-dimensional random walks with root-mean-square (RMS) step-size  $a$  has a Gaussian or normal probability distribution as  $N \rightarrow \infty$ ,

$$\rho(x) = \frac{1}{\sqrt{2\pi}\sigma} \exp(-x^2/2\sigma^2), \quad (2.35)$$

with  $\sigma = \sqrt{N}a$ .

(c) Calculate the RMS step-size  $a$  for one-dimensional steps uniformly distributed in  $(-1/2, 1/2)$ . Write a routine that plots a histogram of the endpoints of  $W$  one-dimensional random walks with  $N$  steps and 50 bins, along with the prediction of eqn 2.35 for  $x$  in  $(-3\sigma, 3\sigma)$ . Do a histogram with  $W = 10\,000$  and  $N = 1, 2, 3,$  and  $5$ . How quickly does the Gaussian distribution become a good approximation to the random walk?

(2.6) **Fourier and Green.** ②

An initial density profile  $\rho(x, t = 0)$  is perturbed slightly away from a uniform density  $\rho_0$ , as shown in Fig. 2.11. The density obeys the diffusion equation  $\partial\rho/\partial t = D\partial^2\rho/\partial x^2$ , where  $D = 0.001 \text{ m}^2/\text{s}$ . The lump centered at  $x = 5$  is a Gaussian  $\exp(-x^2/2)/\sqrt{2\pi}$ , and the wiggle centered at  $x = 15$  is a smooth envelope function multiplying  $\cos(10x)$ .

(a) Fourier. As a first step in guessing how the pictured density will evolve, let us consider just a cosine wave. If the initial wave were  $\rho_{\cos}(x, 0) = \cos(10x)$ , what would it be at  $t = 10 \text{ s}$ ? Related formulae:  $\tilde{\rho}(k, t) = \tilde{\rho}(k, t')\tilde{G}(k, t - t')$ ;  $\tilde{G}(k, t) = \exp(-Dk^2t)$ .

(b) Green. As a second step, let us check how long it would take to spread out as far as the Gaussian on the left. If the wave at some earlier time  $-t_0$  were a  $\delta$ -function at  $x = 0$ ,  $\rho(x, -t_0) = \delta(x)$ , what choice of the time elapsed  $t_0$  would

<sup>32</sup>This exercise and the associated software were developed in collaboration with Christopher Myers.

<sup>33</sup>The square asymmetry is an irrelevant perturbation on long length and time scales (Chapter 12). Had we kept terms up to fourth order in gradients in the diffusion equation  $\partial\rho/\partial t = D\nabla^2\rho + E\nabla^2(\nabla^2\rho) + F(\partial^4\rho/\partial x^4 + \partial^4\rho/\partial y^4)$ , then  $F$  is square symmetric but not isotropic. It will have a typical size  $\Delta t/a^4$ , so is tiny on scales large compared to  $a$ .



yield a Gaussian  $\rho(x, 0) = \exp(-x^2/2)/\sqrt{2\pi}$  for the given diffusion constant  $D = 0.001 \text{ m}^2/\text{s}$ ? Related formulæ:  $\rho(x, t) = \int \rho(y, t')G(y - x, t - t') dy$ ;  $G(x, t) = (1/\sqrt{4\pi Dt}) \exp(-x^2/(4Dt))$ .

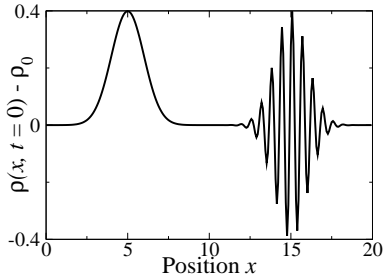
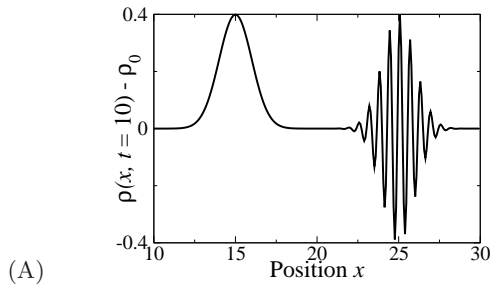
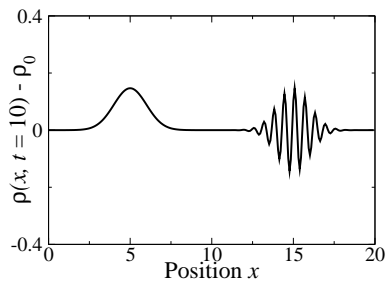


Fig. 2.11 Initial profile of density deviation from average.

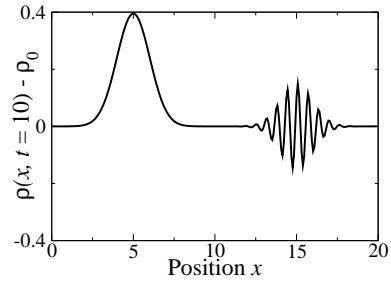
(c) Pictures. Now consider time evolution for the next ten seconds. The initial density profile  $\rho(x, t = 0)$  is as shown in Fig. 2.11. Which of the choices (A)–(E) represents the density at  $t = 10 \text{ s}$ ? (Hint: Compare  $t = 10 \text{ s}$  to the time  $t_0$  from part (b).) Related formulæ:  $\langle x^2 \rangle \sim 2Dt$ .



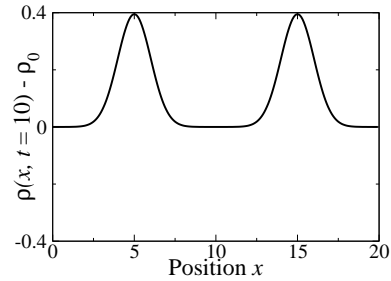
(A)



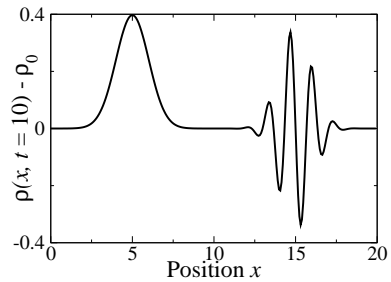
(B)



(C)



(D)



(E)

(2.7) Periodic diffusion. ②

Consider a one-dimensional diffusion equation  $\partial\rho/\partial t = D\partial^2\rho/\partial x^2$ , with initial condition periodic in space with period  $L$ , consisting of a  $\delta$ -function at every  $x_n = nL$ :  $\rho(x, 0) = \sum_{n=-\infty}^{\infty} \delta(x - nL)$ .

(a) Using the Green's function method, give an approximate expression for the the density, valid at short times and for  $-L/2 < x < L/2$ , involving only one term (not an infinite sum). (Hint: How many of the Gaussians are important in this region at early times?)

(b) Using a Fourier series,<sup>34</sup> give an approximate expression for the density, valid at long times, involving only two terms (not an infinite

<sup>34</sup>You can use a Fourier transform, but you will find  $\tilde{\rho}(k, 0)$  is zero except at the values  $k = 2\pi m/L$ , where it is a  $\delta$ -function.

sum). (Hint: How many of the wavelengths are important at late times?)

(c) Give a characteristic time  $\tau$  in terms of  $L$  and  $D$ , such that your answer in (a) is valid for  $t \ll \tau$  and your answer in (b) is valid for  $t \gg \tau$ .

(2.8) **Thermal diffusion.** ②

The rate of energy flow in a material with thermal conductivity  $k_t$  and a temperature field  $T(x, y, z, t) = T(\mathbf{r}, t)$  is  $\mathbf{J} = -k_t \nabla T$ .<sup>35</sup> Energy is locally conserved, so the energy density  $E$  satisfies  $\partial E / \partial t = -\nabla \cdot \mathbf{J}$ .

(a) If the material has constant specific heat  $c_p$  and density  $\rho$ , so  $E = c_p \rho T$ , show that the temperature  $T$  satisfies the diffusion equation  $\partial T / \partial t = k_t / (c_p \rho) \nabla^2 T$ .

(b) By putting our material in a cavity with microwave standing waves, we heat it with a periodic modulation  $T = \sin(kx)$  at  $t = 0$ , at which time the microwaves are turned off. Show that the amplitude of the temperature modulation decays exponentially in time. How does the amplitude decay rate depend on wavelength  $\lambda = 2\pi/k$ ?

(2.9) **Frying pan.** ②

An iron frying pan is quickly heated on a stove top to 400 degrees Celsius. Roughly how long it will be before the handle is too hot to touch (within, say, a factor of two)? (Adapted from [114, p. 40].)

Do this three ways.

(a) Guess the answer from your own experience. If you have always used aluminum pans, consult a friend or parent.

(b) Get a rough answer by a dimensional argument. You need to transport heat  $c_p \rho V \Delta T$  across an area  $A = V / \Delta x$ . How much heat will flow across that area per unit time, if the temperature gradient is roughly assumed to be  $\Delta T / \Delta x$ ? How long  $\delta t$  will it take to transport the amount needed to heat up the whole handle?

(c) Model the problem as the time needed for a pulse of heat at  $x = 0$  on an infinite rod to spread out a root-mean-square distance  $\sigma(t)$  equal to the length of the handle, and use the Green's function for the heat diffusion equation (Exercise 2.8).

Note: For iron, the specific heat  $c_p = 450 \text{ J}/(\text{kg C})$ , the density  $\rho = 7900 \text{ kg}/\text{m}^3$ , and the thermal conductivity  $k_t = 80 \text{ W}/(\text{m C})$ .

(2.10) **Polymers and random walks.** (Computation, Condensed matter) ③

Polymers are long molecules, typically made of identical small molecules called *monomers* that are bonded together in a long, one-dimensional chain. When dissolved in a solvent, the polymer chain configuration often forms a good approximation to a random walk. Typically, neighboring monomers will align at relatively small angles; several monomers are needed to lose memory of the original angle. Instead of modeling all these small angles, we can produce an equivalent problem focusing all the bending in a few hinges; we approximate the polymer by an uncorrelated random walk of straight segments several monomers in length. The equivalent segment size is called the *persistence length*.<sup>36</sup>

(a) If the persistence length to bending of DNA is 50 nm, with 3.4 Å per nucleotide base pair, what will the root-mean-square distance  $\sqrt{\langle R^2 \rangle}$  be between the ends of a gene in solution with 100 000 base pairs, if the DNA is accurately represented as a random walk?

Polymers are not accurately represented as pure random walks, however. Random walks, particularly in low dimensions, often intersect themselves. Polymers are best represented as *self-avoiding* random walks: a polymer samples only those configurations that do not cross themselves.

Let us investigate whether self-avoidance will change the basic nature of the polymer configuration in two dimensions. In particular, does the end-to-end typical distance continue to scale with the square root of the length  $L$  of the polymer,  $R \sim \sqrt{L}$ ?

(b) Two-dimensional self-avoiding random walk. Give a convincing, short argument explaining whether or not a typical, non-self-avoiding random walk in two dimensions will come back after large numbers of monomers and cross itself. (Hint: How big a radius does it extend to? How many times does it traverse this radius?)

Run the code linked to from our web site [129] under 'Self-avoiding random walks' (currently [90]). This site models a two-dimensional random walk as a connected line between nearest-neighbor neighboring lattice points on the square lattice of integers. They

<sup>35</sup>We could have derived this law of thermal conductivity from random walks of phonons, but we have not

<sup>36</sup>Some seem to define the persistence length with a different constant factor.

start random walks at the origin, grow them without allowing backtracking, and discard them when they hit the same lattice point twice. As long as they survive, they average the squared length as a function of the number of steps.

(c) Measure for a reasonable length of time, print out the current state, and enclose it. Did the simulation give  $R \sim \sqrt{L}$ ? If not, what is the estimate that your simulation gives for the exponent  $\nu$  relating  $R$  to  $L$ ? How does it compare with the two-dimensional theoretical exponent  $\nu = 3/4$ ?

(2.11) **Stocks, volatility, and diversification.** (Finance, Computation) ②

Stock prices are fairly good approximations to random walks. The Standard and Poor's 500 index is a weighted average of the prices of five hundred large companies in the United States stock-market.

From the 'Stock market' link on the computer exercises web site [129], download SandPCConstantDollars.dat and the hints files for your preferred programming language. Each line in the data file represents a weekday (no prices are listed on Saturday or Sunday). The first column is time  $t$  (in days, since mid-October 1982), and the second column is the Standard and Poor's index  $SP(t)$  for that day, corrected for inflation (using the consumer price index for that month). Are the random fluctuations in the stock-market due to external events?

(a) Plot the price index versus time. Notice the large peak near year 2000. On September 11, 2001 the World Trade Center was attacked (day number 6903 in the list). Does it seem that the drop in the stock-market after 2000 is due mostly to this external event?

Sometimes large fluctuations are due to external events; the fluctuations in ecological populations and species are also quite random, but the dinosaur extinction was surely caused by a meteor.

What do the steps look like in the random walk of Standard and Poor's index? This depends on how we define a step; do we ask how much it has changed after a year, a month, a week, or a day? A technical question arises: do we measure time in days, or in trading days? We shall follow the finance community, and consider only trading days. So, we will define the lag variable  $\ell$  to be one trading day for a daily percentage change (even if there is a weekend or holiday in between), five for a weekly percentage change, and

252 for a yearly percentage change (the number of trading days in a typical year).

(b) Write a function  $P_\ell$  that finds all pairs of time points from our data file separated by a time interval  $\Delta t = \ell$  and returns a list of per cent changes

$$P_\ell(t) = 100 \frac{SP(t + \ell) - SP(t)}{SP(t)}$$

over that time interval. Plot a histogram of the daily changes, the weekly changes, and the yearly changes. Which of the three represents a reasonable time for you to stay invested in the Standard and Poor's index (during which you have mean percentage growth larger than a tiny fraction of the fluctuations)? Also, why do you think the yearly changes look so much more complicated than the other distributions? (Hint for the latter question: How many years are there in the data sample? Are the steps  $SP(n) - SP(n - \ell)$  independent from  $SP(m) - SP(m - \ell)$  for  $n - m < \ell$ ? The fluctuations are determined not by the total number of steps, but by the effective number of independent steps in the random walk.)

The distributions you found in part (b) for the shorter lags should have looked quite close to Gaussian—corresponding nicely to our Green's function analysis of random walks, or more generally to the central limit theorem. Those in mathematical finance, though, are interested in the deviations from the expected behavior. They have noticed that the tails of the distribution deviate from the predicted Gaussian.

(c) Show that the logarithm of a Gaussian is an inverted parabola. Plot the logarithm of the histogram of the weekly percentage changes from part (b). Are there more large percentage changes than expected from a Gaussian distribution (fat tails) or fewer? (Hint: Far in the tails the number of measurements starts becoming sparse, fluctuating between zero and one. Focus on the region somewhat closer in to the center, where you have reasonable statistics.)

Some stocks, stock funds, or indices are more risky than others. This is not to say that one on average loses money on risky investments; indeed, they usually on average pay a better return than conservative investments. Risky stocks have a more variable return; they sometimes grow faster than anticipated but sometimes decline steeply. Risky stocks have a high standard deviation in their percentage return. In finance, the standard deviation of the percentage return

is called the *volatility*

$$v_\ell = \sqrt{\langle (P_\ell(t) - \bar{P}_\ell)^2 \rangle}.$$

(d) Calculate the daily volatility, the weekly volatility, and the monthly volatility of the inflation-corrected Standard and Poor's 500 data. Plot the volatility as a function of lag, and the volatility squared as a function of lag, for lags from zero to 100 days. Does it behave as a random walk should?

The volatility of a stock is often calculated from the price fluctuations within a single day, but it is then *annualized* to estimate the fluctuations after a year, by multiplying by the square root of 252.

The individual stocks in the Standard and Poor's 500 index will mostly have significantly higher volatility than the index as a whole.

(e) Suppose these five hundred stocks had mean annual percentage returns  $m_i$  and each had mean volatility  $\sigma_i$ . Suppose they were equally weighted in the index, and their fluctuations were uncorrelated. What would the return and volatility for the index be? Without inside information<sup>37</sup> or insight as to which stocks will have higher mean returns, is there any average disadvantage of buying portions of each stock over buying the index? Which has lower volatility?

Investment advisers emphasize the importance of *diversification*. The fluctuations of different stocks are not independent, especially if they are in the same industry; one should have investments spread out between different sectors of the economy, and between stocks and bonds and other types of investments, in order to avoid risk and volatility.

(2.12) **Computational finance: pricing derivatives.**<sup>38</sup> (Finance) ②

Suppose you hope to buy a particular house in two years when you get your degree. You are worried about it going way up in price (you have budgeted 'only' \$100,000), but you do not wish to purchase it now. Furthermore, your plans may change. What you want is a *call option*,<sup>39</sup>

where you pay a few thousand dollars to the current owner, who promises (if you choose to exercise your option) to sell the house to you in two years for \$100,000. Your mother, who plans to retire in fifteen years, might want a *put* option, which for a fee gives her the option to sell the house at a fixed price in fifteen years. Since these options are not tangible property, but they *derive* their value from something else (here a house), these options are called *derivatives*. Derivatives are not common in housing transactions, but they are big business in stocks and in foreign currencies.<sup>40</sup>

The buyer of the option is shielding themselves from risk; the seller of the option gets cash now in exchange for risking an unusual price rise or drop in the future. What price should the seller of the option charge you for incurring this risk? The rather elegant answer to this question is given by the *Black-Scholes* model [101], and launched a multi-trillion dollar industry.

Black and Scholes make several assumptions: no jumps in stock prices, instant trading, etc. These assumed, there is a risk-free strategy and a *fair price* for the derivative, at which no net profit is made. (The 1987 market crash may have been caused by traders using the model, a seeming conspiracy to punish those who think they can eliminate risk.) We treat a special case.

- There are only two investments in the world: a risky asset (which we will call a stock) and cash (a risk-free investment). Initially the stock is worth  $X_0$ ; cash is worth 1.
- The stock has one of two values at the date of the option (the expiration date),  $X_u > X_d$ .<sup>41</sup>
- The interest rates are zero, so the cash at the expiration date is still worth 1. (This does not change anything fundamental.)
- We can borrow and lend any amount of cash at the prevailing interest rate (that is, zero) and can buy or sell stock (even if we do not own any; this is called *selling short*). There are no transaction costs.

<sup>37</sup>Insider trading is illegal.

<sup>38</sup>This exercise was developed in collaboration with Eric Grannan, based on Hull [61].

<sup>39</sup>Technically, this is a European-style call option; an American-style option would allow you to buy the house at any time in the next two years, not just at the end date.

<sup>40</sup>If you sell widgets for dollars, but pay salaries in pesos, you are likely to want to buy insurance to help out if the dollar falls dramatically with respect to the peso between now and when you are paid for the widgets.

<sup>41</sup>Having only two final prices makes the calculation less complicated. The subscripts  $u$  and  $d$  stand for up and down.

Let the two possible values of the option at the expiration date be  $V_u$  and  $V_d$ .<sup>42</sup> Let  $V_0$  be the fair initial price of the derivative that we wish to determine.

Consider a portfolio  $\mathcal{P}$  that includes the derivative and a certain amount  $\alpha$  of the stock. Initially the value of  $\mathcal{P}$  is  $P_0 = V_0 + \alpha X_0$ . At the expiration date the value will either be  $V_u + \alpha X_u$  or  $V_d + \alpha X_d$ .

(a) What value of  $\alpha$  makes these two final portfolio values equal? What is this common final value  $P_F$ ?

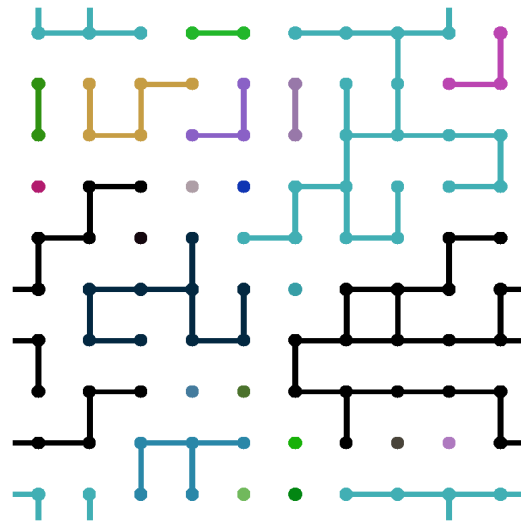
(b) What initial value  $V_0$  of the derivative makes the initial value of the portfolio equal to the final value? (Express your answer first in terms of  $P_F$ ,  $\alpha$ , and  $X_0$ , before substituting in your answers for part (a).) This is the value at which no net profit is made by either buyer or seller of the derivative; on average, the derivative gives the same return as cash.

(c) Does your answer depend upon the probabilities  $p_u$  and  $p_d$  of going up or down?

This portfolio is a weighted average of derivative and stock that makes the owner indifferent as to whether the stock goes up or down. It becomes a risk-free asset, and so its value must increase at the risk-free rate; this is the fundamental insight of *arbitrage* pricing. (An arbitrage is roughly a situation where there is free money to be made; a strategy for updating a portfolio where some final states have positive value and no final states have negative value with respect to risk-free investments. In an *efficient market*, there are no opportunities for arbitrage; large investors have bought and sold until no free money is available.) You can run exactly the same argument for more than one time step, starting at the final state where the values of the derivative are known, and working your way back to the initial state; this is the *binomial tree* method of pricing options. If the market is efficient, the average growth in the value of the stock must also grow at the risk-free rate, so the only unknown is the volatility of the stock (how large the fluctuations are in the stock price, Exercise 2.11). In the continuum limit this tree becomes the famous Black–Scholes partial differential equation.

(2.13) **Building a percolation network.**<sup>43</sup> (Complexity, Computation) ④

Figure 2.12 shows what a large sheet of paper, held at the edges, would look like if small holes were successively punched out at random locations. Here the ensemble averages over the different choices of random locations for the holes; this figure shows the sheet just before it fell apart. Certain choices of hole positions would cut the sheet in two far earlier (a straight line across the center) or somewhat later (checkerboard patterns), but for the vast majority of members of our ensemble the paper will have the same kinds of hole patterns seen here. Again, it is easier to analyze all the possible patterns of punches than to predict a particular pattern.



**Fig. 2.12 Bond percolation network.** Each bond on a  $10 \times 10$  square lattice is present with probability  $p = 0.4$ . This is below the percolation threshold  $p = 0.5$  for the infinite lattice, and indeed the network breaks up into individual clusters (each shaded separately). Note the periodic boundary conditions. Note there are many small clusters, and only a few large ones; here twelve clusters of size  $S = 1$ , three of size  $S = 2$ , and one cluster of size  $S = 29$  (black). For a large lattice near the percolation threshold the probability distribution of cluster sizes  $\rho(S)$  forms a power law (Exercise 12.12).

<sup>42</sup>For example, if the derivative is a call option allowing the buyer to purchase the stock at  $X_f$  with  $X_u > X_f > X_d$ , the value of the derivative at the expiration date will either be  $V_u = X_u - X_f$  or  $V_d = 0$  (since in the latter case the buyer would choose not to exercise the option).

<sup>43</sup>This exercise and the associated software were developed in collaboration with Christopher Myers.

Percolation theory is the study of the qualitative change in connectivity of a large system as its components are randomly removed. Outside physics, it has become an archetype of criticality at continuous transitions, presumably because the problem is simple to state and the analysis does not demand a background in equilibrium statistical mechanics.<sup>44</sup> In this exercise, we will study bond percolation and site percolation (Figs 2.12 and 2.13) in two dimensions.

In the computer exercises portion of the web site for this book [129], you will find some hint files and graphic routines to facilitate the working of this exercise.

*Bond percolation on a square lattice.*

(a) Define a 2D bond percolation network with periodic boundary conditions on the computer, for size  $L \times L$  and bond probability  $p$ . For this exercise, the nodes will be represented by pairs of integers  $(i, j)$ . You will need the method `GetNeighbors(node)`, which returns the neighbors of an existing node. Use the bond-drawing software provided to draw your bond percolation network for various  $p$  and  $L$ , and use it to check that you have implemented the periodic boundary conditions correctly. (There are two basic approaches. You can start with an empty network and use `AddNode` and `AddEdge` in loops to generate the nodes, vertical bonds, and horizontal bonds (see Exercise 1.7). Alternatively, and more traditionally, you can set up a 2D array of vertical and horizontal bonds, and implement `GetNeighbors(node)` by constructing the list of neighbors from the bond networks when the site is visited.)

*The percolation threshold and duality.* In most continuous phase transitions, one of the challenges is to find the location of the transition. We chose bond percolation on the square lattice because one can argue, in the limit of large systems, that the percolation threshold  $p_c = 1/2$ . The argument makes use of the *dual lattice*.

The nodes of the dual lattice are the centers of the squares between nodes in the original lattice. The edges of the dual lattice are those which do not cross an edge of the original lattice. Since every potential dual edge crosses exactly one edge of the original lattice, the probability  $p^*$  of having bonds on the dual lattice is  $1 - p$ , where  $p$  is

the probability of bonds for the original lattice. If we can show that the dual lattice percolates if and only if the original lattice does not, then  $p_c = 1/2$ . This is easiest to see graphically.

(b) Generate and print a small lattice with  $p = 0.4$ , picking one where the largest cluster does not span across either the vertical or the horizontal direction (or print Fig. 2.12). Draw a path on the dual lattice spanning the system from top to bottom and from left to right. (You will be emulating a rat running through a maze.) Is it clear for large systems that the dual lattice will percolate if and only if the original lattice does not?

*Finding the clusters.*

(c) Write the following two functions that together find the clusters in the percolation network.

- (1) `FindClusterFromNode(graph, node, visited)`, which returns the cluster in `graph` containing `node`, and marks the sites in the cluster as having been visited. The cluster is the union of `node`, the neighbors, the neighbors of the neighbors, etc. The trick is to use the set of visited sites to avoid going around in circles. The efficient algorithm is a breadth-first traversal of the graph, working outward from `node` in shells. There will be a `currentShell` of nodes whose neighbors have not yet been checked, and a `nextShell` which will be considered after the current one is finished (hence breadth first), as follows.
  - Initialize `visited[node] = True`, `cluster = [node]`, and `currentShell = graph.GetNeighbors(node)`.
  - While there are nodes in the new `currentShell`:
    - \* start a new empty `nextShell`;
    - \* for each node in the current shell, if the node has not been visited,
      - add the node to the cluster,
      - mark the node as visited,
      - and add the neighbors of the node to the `nextShell`;
    - \* set the current shell to `nextShell`.

<sup>44</sup>Percolation is, in a formal sense, an equilibrium phase transition. One can show that percolation is the  $q \rightarrow 1$  limit of an equilibrium  $q$ -state Potts model—a model where each site has a spin which can take  $q$  different states (so  $q = 2$  is the Ising model) [25, section 8.4]. But you do not need partition functions and the Boltzmann distribution to define the problem, or to study it.

- Return the cluster.
- (2) `FindAllClusters(graph)`, which sets up the `visited` set to be `False` for all nodes, and calls `FindClusterFromNode(graph, node, visited)` on all nodes that have not been visited, collecting the resulting clusters. Optionally, you may want to order the clusters from largest to smallest, for convenience in the graphics (and in finding the largest cluster).

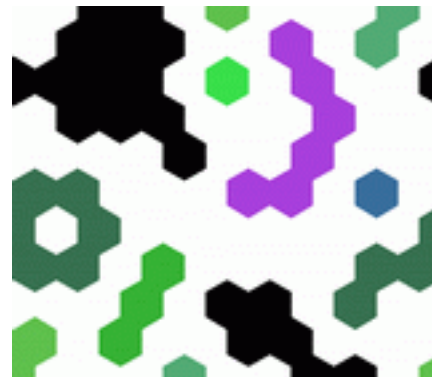
Check your code by running it for small  $L$  and using the graphics software provided. Are the clusters, drawn in different colors, correct?

*Site percolation on a triangular lattice.* Universality states that the statistical behavior of the percolation clusters at long length scales should be independent of the microscopic detail. That is, removing bonds from a square lattice should leave the same fractal patterns of holes, near  $p_c$ , as punching out circular holes in a sheet just before it falls apart. Nothing about your algorithms from part (c) depended on their being four neighbors of a node, or their even being nodes at all sites. Let us implement site percolation on a triangular lattice (Fig. 2.13); nodes are occupied with probability  $p$ , with each node connected to any of its six neighbor sites that are also filled (punching out hexagons from a sheet of paper). The triangular site lattice also has a duality transformation, so again  $p_c = 0.5$ .

It is computationally convenient to label the site at  $(x, y)$  on a triangular lattice by  $[i, j]$ , where  $x = i + j/2$  and  $y = (\sqrt{3}/2)j$ . If we again use periodic boundary conditions with  $0 \leq i < L$  and  $0 \leq j < L$ , we cover a region in the shape of a  $60^\circ$  rhombus.<sup>45</sup> Each site  $[i, j]$  has six neighbors, at  $[i, j] + e$  with  $e = [1, 0], [0, 1], [-1, 1]$  upward and to the right, and minus the same three downward and to the left.

- (d) Generate a site percolation network on a triangular lattice. You can treat the sites one at a time, using `AddNode` with probability  $p$ , and check `HasNode(neighbor)` to bond to all existing neigh-

bors. Alternatively, you can start by generating a whole matrix of random numbers in one sweep to determine which sites are occupied by nodes, add those nodes, and then fill in the bonds. Check your resulting network by running it for small  $L$  and using the graphics software provided. (Notice the shifted periodic boundary conditions at the top and bottom, see Fig. 2.13.) Use your routine from part (c) to generate the clusters, and check these (particularly at the periodic boundaries) using the graphics software.



**Fig. 2.13 Site percolation network.** Each site on a  $10 \times 10$  triangular lattice is present with probability  $p = 0.5$ , the percolation threshold for the infinite lattice. Note the periodic boundary conditions at the sides, and the shifted periodic boundaries at the top and bottom.

- (e) Generate a small square-lattice bond percolation cluster, perhaps  $30 \times 30$ , and compare with a small triangular-lattice site percolation cluster. They should look rather different in many ways. Now generate a large<sup>46</sup> cluster of each, perhaps  $1000 \times 1000$  (or see Fig. 12.7). Stepping back and blurring your eyes, do the two look substantially similar?

Chapter 12 and Exercise 12.12 will discuss percolation theory in more detail.

<sup>45</sup>The graphics software uses the periodic boundary conditions to shift this rhombus back into a rectangle.

<sup>46</sup>Your code, if written properly, should run in a time of order  $N$ , the number of nodes. If it seems to slow down more than a factor of 4 when you increase the length of the side by a factor of two, then check for inefficiencies.





# Temperature and equilibrium



We now turn to equilibrium statistical mechanics—a triumph of the nineteenth century. Equilibrium statistical mechanics provided them the fundamental definition for temperature and the laws determining the behavior of all common liquids and gases.<sup>1</sup> We will switch in this chapter between discussing the general theory and applying it to a particular system—the ideal gas. The ideal gas provides a tangible example of the formalism, and its analysis will provide a preview of material coming in the next few chapters.

A system which is not acted upon by the external world<sup>2</sup> is said to approach *equilibrium* if and when it settles down<sup>3</sup> at long times to a state which is independent of the initial conditions (except for conserved quantities like the total energy). Statistical mechanics describes the equilibrium state as an average over all states in *phase space* consistent with the conservation laws; this *microcanonical ensemble* is introduced in Section 3.1. In Section 3.2, we shall calculate the properties of the ideal gas using the microcanonical ensemble. In Section 3.3 we shall define *entropy* and *temperature* for equilibrium systems, and argue from the microcanonical ensemble that heat flows to maximize the entropy and equalize the temperature. In Section 3.4 we will derive the formula for the *pressure* in terms of the entropy, and define the *chemical potential*. Finally, in Section 3.5 we calculate the entropy, temperature, and pressure for the ideal gas, and introduce two refinements to our definitions of phase-space volume.

<b>3.1 The microcanonical ensemble</b>	<b>37</b>
<b>3.2 The microcanonical ideal gas</b>	<b>39</b>
<b>3.3 What is temperature?</b>	<b>44</b>
<b>3.4 Pressure and chemical potential</b>	<b>47</b>
<b>3.5 Entropy, the ideal gas, and phase-space refinements</b>	<b>51</b>

<sup>1</sup>Quantum statistical mechanics is necessary to understand solids at low temperatures.

<sup>2</sup>If the system is driven (i.e., there are externally imposed forces or currents) we instead call this final condition the *steady state*.

<sup>3</sup>If the system is large, the equilibrium state will also usually be time independent and ‘calm’, hence the name. Small systems will continue to fluctuate substantially even in equilibrium.

## 3.1 The microcanonical ensemble

Statistical mechanics allows us to solve *en masse* many problems that are impossible to solve individually. In this chapter we address the general equilibrium behavior of  $N$  atoms in a box of volume  $V$ —any kinds of atoms, in an arbitrary external potential.<sup>4</sup> Let us presume for simplicity that the walls of the box are smooth and rigid, so that energy is conserved when atoms bounce off the walls. This makes our system *isolated*, independent of the world around it.

How can we solve for the behavior of our atoms? We can in principle determine the positions<sup>5</sup>  $\mathbb{Q} = (x_1, y_1, z_1, x_2, \dots, x_N, y_N, z_N) = (q_1, \dots, q_{3N})$  and momenta  $\mathbb{P} = (p_1, \dots, p_{3N})$  of the particles at any

<sup>4</sup>However, we do ignore quantum mechanics until Chapter 7.

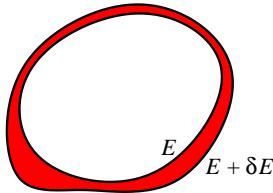
<sup>5</sup>The  $3N$ -dimensional space of positions  $\mathbb{Q}$  is called *configuration space*. The  $3N$ -dimensional space of momenta  $\mathbb{P}$  is called *momentum space*. The  $6N$ -dimensional space  $(\mathbb{P}, \mathbb{Q})$  is called *phase space*.

<sup>6</sup>Here  $\mathbf{m}$  is a diagonal matrix if the particles are not all the same mass.

<sup>7</sup>This scrambling is precisely the approach to equilibrium.

<sup>8</sup>In an infinite system, total momentum and angular momentum would also be conserved; the box breaks rotation and translation invariance.

<sup>9</sup>What about quantum mechanics, where the energy levels in a finite system are discrete? In that case (Chapter 7), we will need to keep  $\delta E$  large compared to the spacing between energy eigenstates, but small compared to the total energy.



**Fig. 3.1 Energy shell.** The shell of energies between  $E$  and  $E + \delta E$  can have an irregular ‘thickness’. The volume of this shell in  $6N$ -dimensional phase space, divided by  $\delta E$ , is the definition of  $\Omega(E)$ . Notice that the microcanonical average weights the thick regions more heavily. In Section 4.1 we will show that, just as a water drop in a river spends more time in the deep sections where the water flows slowly, so also a trajectory in phase space spends more time in the thick regions.

future time given their initial positions and momenta using Newton’s laws:

$$\dot{\mathbf{Q}} = \mathbf{m}^{-1}\mathbb{P}, \quad \dot{\mathbf{P}} = \mathbb{F}(\mathbf{Q}) \tag{3.1}$$

(where  $\mathbb{F}$  is the  $3N$ -dimensional force due to the other particles and the walls, and  $\mathbf{m}$  is the particle mass).<sup>6</sup>

In general, solving these equations is plainly not feasible.

- Many systems of interest involve far too many particles to allow one to solve for their trajectories.
- Most systems of interest exhibit chaotic motion, where the time evolution depends with ever increasing sensitivity on the initial conditions—you cannot know enough about the current state to predict the future.
- Even if it were possible to evolve our trajectory, knowing the solution would for most purposes be useless; we are far more interested in the typical number of atoms striking a wall of the box, say, than the precise time a particular particle hits.

How can we extract the simple, important predictions out of the complex trajectories of these atoms? The chaotic time evolution will rapidly scramble<sup>7</sup> whatever knowledge we may have about the initial conditions of our system, leaving us effectively knowing only the conserved quantities—for our system, just the total energy  $E$ .<sup>8</sup> Rather than solving for the behavior of a particular set of initial conditions, let us hypothesize that the energy is all we need to describe the equilibrium state. This leads us to a statistical mechanical description of the equilibrium state of our system as an ensemble of all possible states with energy  $E$ —the *microcanonical ensemble*.

We calculate the properties of our ensemble by averaging over states with energies in a shell ( $E, E + \delta E$ ) taking the limit<sup>9</sup>  $\delta E \rightarrow 0$  (Fig. 3.1). Let us define the function  $\Omega(E)$  to be the phase-space volume of this thin shell, divided by  $\delta E$ :<sup>10</sup>

$$\Omega(E) \delta E = \int_{E < \mathcal{H}(\mathbb{P}, \mathbb{Q}) < E + \delta E} d\mathbb{P} d\mathbb{Q}. \tag{3.5}$$

<sup>10</sup>More formally, one can write the energy shell  $E < \mathcal{H}(\mathbb{P}, \mathbb{Q}) < E + \delta E$  in terms of the Heaviside step function  $\Theta(x)$ , where  $\Theta(x) = 1$  for  $x \geq 0$ , and  $\Theta(x) = 0$  for  $x < 0$ . We see that  $\Theta(E + \delta E - \mathcal{H}) - \Theta(E - \mathcal{H})$  is one precisely inside the energy shell (Fig. 3.1). In the limit  $\delta E \rightarrow 0$ , we can write  $\Omega(E)$  as a derivative:

$$\Omega(E) \delta E = \int_{E < \mathcal{H}(\mathbb{P}, \mathbb{Q}) < E + \delta E} d\mathbb{P} d\mathbb{Q} = \int d\mathbb{P} d\mathbb{Q} [\Theta(E + \delta E - \mathcal{H}) - \Theta(E - \mathcal{H})] = \delta E \frac{\partial}{\partial E} \int d\mathbb{P} d\mathbb{Q} \Theta(E - \mathcal{H}), \tag{3.2}$$

and the expectation of a general operator  $O$  as

$$\langle O \rangle = \frac{1}{\Omega(E)} \int d\mathbb{P} d\mathbb{Q} [\Theta(E + \delta E - \mathcal{H}) - \Theta(E - \mathcal{H})] O(\mathbb{P}, \mathbb{Q}) = \frac{1}{\Omega(E)} \frac{\partial}{\partial E} \int d\mathbb{P} d\mathbb{Q} \Theta(E - \mathcal{H}) O(\mathbb{P}, \mathbb{Q}). \tag{3.3}$$

It will be important later to note that the derivatives in eqns 3.2 and 3.3 are at constant  $N$  and constant  $V$ :  $(\partial/\partial E)|_{V, N}$ . Finally, we know the derivative of the Heaviside function is the Dirac  $\delta$ -function (see note 4 on p. 6). Thus we have

$$\Omega(E) = \int d\mathbb{P} d\mathbb{Q} \delta(E - \mathcal{H}(\mathbb{P}, \mathbb{Q})), \quad \langle O \rangle = \frac{1}{\Omega(E)} \int d\mathbb{P} d\mathbb{Q} \delta(E - \mathcal{H}(\mathbb{P}, \mathbb{Q})) O(\mathbb{P}, \mathbb{Q}). \tag{3.4}$$

Thus the microcanonical ensemble can be written as a probability density  $\delta(E - \mathcal{H}(\mathbb{P}, \mathbb{Q})) / \Omega(E)$  in phase space.

Here  $\mathcal{H}(\mathbb{P}, \mathbb{Q})$  is the Hamiltonian for our system.<sup>11</sup> Finding the average  $\langle O \rangle$  of a property in the microcanonical ensemble is done by averaging  $O(\mathbb{P}, \mathbb{Q})$  over this same energy shell:

$$\langle O \rangle_E = \frac{1}{\Omega(E)\delta E} \int_{E < \mathcal{H}(\mathbb{P}, \mathbb{Q}) < E + \delta E} O(\mathbb{P}, \mathbb{Q}) \, d\mathbb{P} \, d\mathbb{Q}. \quad (3.6)$$

Notice that, by averaging equally over all states in phase space compatible with our knowledge about the system (that is, the conserved energy), we have made a hidden assumption: all points in phase space (with a given energy) are a priori equally likely, so the average should treat them all with equal weight. In Section 3.2, we will see that this assumption leads to sensible behavior, by solving the case of an ideal gas.<sup>12</sup> We will fully justify this equal-weighting assumption in Chapter 4, where we will also discuss the more challenging question of why so many systems actually reach equilibrium.

The fact that the microcanonical distribution describes equilibrium systems should be amazing to you. The long-time equilibrium behavior of a system is precisely the typical behavior of all systems with the same value of the conserved quantities. This fundamental ‘regression to the mean’ is the basis of statistical mechanics.

## 3.2 The microcanonical ideal gas

We can *talk* about a general collection of atoms, and derive general statistical mechanical truths for them, but to *calculate* specific properties we must choose a particular system. The archetypal statistical mechanical system is the monatomic<sup>13</sup> ideal gas. You can think of helium atoms at high temperatures and low densities as a good approximation to this ideal gas—the atoms have very weak long-range interactions and rarely collide. The ideal gas will be the limit when the interactions between particles vanish.<sup>14</sup>

For the ideal gas, the energy does not depend upon the spatial configuration  $\mathbb{Q}$  of the particles. This allows us to study the positions (Section 3.2.1) separately from the momenta (Section 3.2.2).

### 3.2.1 Configuration space

Since the energy is independent of the position, our microcanonical ensemble must weight all configurations equally. That is to say, it is precisely as likely that all the particles will be within a distance  $\epsilon$  of the middle of the box as it is that they will be within a distance  $\epsilon$  of any other particular configuration.

What is the probability density  $\rho(\mathbb{Q})$  that the ideal gas particles will be in a particular configuration  $\mathbb{Q} \in \mathbb{R}^{3N}$  inside the box of volume  $V$ ? We know  $\rho$  is a constant, independent of the configuration. We know that the gas atoms are in *some* configuration, so  $\int \rho \, d\mathbb{Q} = 1$ . The integral

<sup>11</sup>The Hamiltonian  $\mathcal{H}$  is the function of  $\mathbb{P}$  and  $\mathbb{Q}$  that gives the energy. For our purposes, this will always be

$$\frac{\mathbb{P}^2}{2m} + U(\mathbb{Q}) = \sum_{\alpha=1}^{3N} \frac{p_{\alpha}^2}{2m} + U(q_1, \dots, q_{3N}),$$

where the force in Newton’s laws (eqn 3.1) is  $F_{\alpha} = -\partial U / \partial q_{\alpha}$ .

<sup>12</sup>In Section 3.5, we shall add two refinements to our definition of the energy-shell volume  $\Omega(E)$ .

<sup>13</sup>Air is a mixture of gases, but most of the molecules are diatomic:  $O_2$  and  $N_2$ , with a small admixture of triatomic  $CO_2$  and monatomic Ar. The properties of diatomic ideal gases are only slightly more complicated than the monatomic gas; one must keep track of the internal rotational degree of freedom and, at high temperatures, the vibrational degrees of freedom.

<sup>14</sup>With no interactions, how can the ideal gas reach equilibrium? If the particles never collide, they will forever be going with whatever initial velocity we started them. We imagine delicately taking the long-time limit first, before taking the limit of infinitely weak interactions, so we can presume an equilibrium distribution has been established.

over the positions gives a factor of  $V$  for each of the  $N$  particles, so  $\rho(\mathbb{Q}) = 1/V^N$ .

It may be counterintuitive that unusual configurations, like all the particles on the right half of the box, have the same probability density as more typical configurations. If there are two non-interacting particles in an  $L \times L \times L$  box centered at the origin, what is the probability that both are on the right (have  $x > 0$ )? The probability that two particles are on the right half is the integral of  $\rho = 1/L^6$  over the six-dimensional volume where both particles have  $x > 0$ . The volume of this space is  $(L/2) \times L \times L \times (L/2) \times L \times L = L^6/4$ , so the probability is  $1/4$ , just as one would calculate by flipping a coin for each particle. The probability that  $N$  such particles are on the right is  $2^{-N}$ —just as your intuition would suggest. Do not confuse probability density with probability! The unlikely states for molecules are not those with small probability density. Rather, they are states with small net probability, because their allowed configurations and/or momenta occupy insignificant volumes of the total phase space.

Notice that configuration space typically has dimension equal to several times Avogadro's number.<sup>15</sup> Enormous-dimensional vector spaces have weird properties—which directly lead to important principles in statistical mechanics.

As an example of weirdness, most of configuration space has almost exactly half the  $x$ -coordinates on the right side of the box. If there are  $2N$  non-interacting particles in the box, what is the probability  $P_m$  that  $N + m$  of them will be in the right half? There are  $2^{2N}$  equally likely ways the distinct particles could sit in the two sides of the box. Of these,  $\binom{2N}{N+m} = (2N)!/((N+m)!(N-m)!)$  have  $m$  extra particles in the right half.<sup>16</sup> So,

$$P_m = 2^{-2N} \binom{2N}{N+m} = 2^{-2N} \frac{(2N)!}{(N+m)!(N-m)!}. \quad (3.7)$$

We can calculate the fluctuations in the number on the right using Stirling's formula,<sup>17</sup>

$$n! \sim (n/e)^n \sqrt{2\pi n} \sim (n/e)^n. \quad (3.8)$$

For now, let us use the second, less accurate form; keeping the factor  $\sqrt{2\pi n}$  would fix the prefactor in the final formula (Exercise 3.9) which we will instead derive by normalizing the total probability to one. Using Stirling's formula, eqn 3.7 becomes

$$\begin{aligned} P_m &\approx 2^{-2N} \left(\frac{2N}{e}\right)^{2N} / \left(\frac{N+m}{e}\right)^{N+m} \left(\frac{N-m}{e}\right)^{N-m} \\ &= N^{2N} (N+m)^{-(N+m)} (N-m)^{-(N-m)} \\ &= (1+m/N)^{-(N+m)} (1-m/N)^{-(N-m)} \\ &= ((1+m/N)(1-m/N))^{-N} (1+m/N)^{-m} (1-m/N)^m \\ &= (1-m^2/N^2)^{-N} (1+m/N)^{-m} (1-m/N)^m, \end{aligned} \quad (3.9)$$

<sup>15</sup>A gram of hydrogen has approximately  $N = 6.02 \times 10^{23}$  atoms, known as Avogadro's number. So, a typical  $3N$  will be around  $10^{24}$ .

<sup>16</sup> $\binom{p}{q}$  is the number of ways of choosing an unordered subset of size  $q$  from a set of size  $p$ . There are  $p(p-1) \cdots (p-q+1) = p!/(p-q)!$  ways of choosing an ordered subset, since there are  $p$  choices for the first member and  $p-1$  for the second, ... There are  $q!$  different ordered sets for each unordered one, so  $\binom{p}{q} = p!/(q!(p-q)!)$ .

<sup>17</sup>Stirling's formula tells us that the 'average' number in the product  $n! = n(n-1) \cdots 1$  is roughly  $n/e$ ; see Exercise 1.4.

and, since  $|m| \ll N$  we may substitute  $1 + \epsilon \approx \exp(\epsilon)$ , giving us

$$P_m \approx \left( e^{-m^2/N^2} \right)^{-N} \left( e^{m/N} \right)^{-m} \left( e^{-m/N} \right)^m \approx P_0 \exp(-m^2/N), \tag{3.10}$$

where  $P_0$  is the prefactor we missed by not keeping enough terms in Stirling's formula. We know that the probabilities must sum to one, so again for  $|m| \ll N$ , we have  $1 = \sum_m P_m \approx \int_{-\infty}^{\infty} P_0 \exp(-m^2/N) dm = P_0 \sqrt{\pi N}$ . Hence

$$P_m \approx \sqrt{\frac{1}{\pi N}} \exp\left(-\frac{m^2}{N}\right). \tag{3.11}$$

This is a nice result: it says that the number fluctuations are distributed in a Gaussian or normal distribution<sup>18</sup>  $(1/\sqrt{2\pi}\sigma) \exp(-x^2/2\sigma^2)$  with a standard deviation  $\sigma = \sqrt{N/2}$ . If we have Avogadro's number of particles  $N \sim 10^{24}$ , then the fractional fluctuations  $\sigma/N = 1/\sqrt{2N} \sim 10^{-12} = 0.0000000001\%$ . In almost all the volume of a box in  $\mathbb{R}^{3N}$ , almost exactly half of the coordinates are on the right half of their range. In Section 3.2.2 we will find another weird property of high-dimensional spaces.

In general, the relative fluctuations of most quantities of interest in equilibrium statistical mechanics go as  $1/\sqrt{N}$ . *For many properties of macroscopic systems, statistical mechanical fluctuations about the average value are very small.*<sup>19</sup>

### 3.2.2 Momentum space

Working with the microcanonical momentum distribution is more challenging,<sup>20</sup> but more illuminating, than working with the ideal gas configuration space of the last section. Here we must study the geometry of spheres in high dimensions.

The kinetic energy for particles (whether or not they interact) is

$$\sum_{\alpha=1}^{3N} \frac{1}{2} m_{\alpha} v_{\alpha}^2 = \sum_{\alpha=1}^{3N} \frac{p_{\alpha}^2}{2m_{\alpha}} = \frac{\mathbb{P}^2}{2m}, \tag{3.12}$$

where the last form assumes all of our atoms have the same mass  $m$ . Hence the condition that a system of equal-mass particles has energy  $E$  is that the system lies on a sphere in  $3N$ -dimensional momentum space of radius  $R = \sqrt{2mE}$ . Mathematicians<sup>21</sup> call this the  $3N-1$  sphere,  $\mathbb{S}_R^{3N-1}$ . Specifically, if the energy of the system is known to be in a small range between  $E$  and  $E + \delta E$ , what is the corresponding volume of momentum space? The volume  $\mu(\mathbb{S}_R^{\ell-1})$  of the  $\ell-1$  sphere (in  $\ell$  dimensions) of radius  $R$  is<sup>22</sup>

$$\mu(\mathbb{S}_R^{\ell-1}) = \pi^{\ell/2} R^{\ell} / (\ell/2)!. \tag{3.13}$$

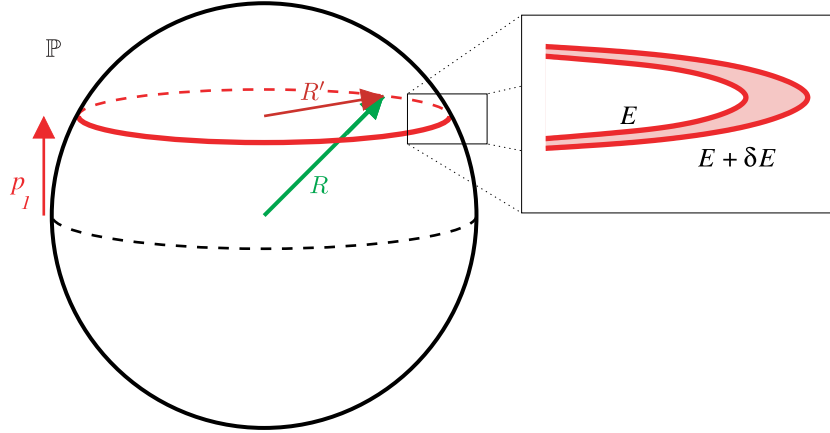
<sup>18</sup>This is the central limit theorem again. We derived it in Section 2.4.2 using random walks and a continuum approximation, instead of Stirling's formula; the Gaussian was the Green's function for the number of heads in  $2N$  coin flips. We will derive it again in Exercise 12.11 using renormalization-group methods.

<sup>19</sup>We will show this in great generality in Section 10.7, see eqn 10.50.

<sup>20</sup>The numerical factors won't be important here: it is just easier to keep them than to explain why we don't need to. Watch the factors of  $R$ . In Section 6.2 we will find that these same derivations are far less complex using the canonical distribution.

<sup>21</sup>Mathematicians like to name surfaces, or manifolds, after the number of dimensions or local coordinates internal to the manifold, rather than the dimension of the space the manifold lives in. After all, one can draw a circle embedded in any number of dimensions (down to two). Thus a basketball is a two sphere  $\mathbb{S}^2$ , the circle is the one sphere  $\mathbb{S}^1$ , and the zero sphere  $\mathbb{S}^0$  consists of the two points  $\pm 1$ .

<sup>22</sup>Does this give the area of a circle in  $\ell = 2$  dimensions? The factorial function can be defined for non-integers (see Exercise 1.5);  $(3/2)! = 3\sqrt{\pi}/4$  and eqn 3.13 imply the correct area of a sphere in three dimensions. The formula in general dimensions is an induction exercise in multiple integration. Hint: It is easiest to do the integrals two dimensions at a time.



**Fig. 3.2** The energy surface in momentum space is the  $3N-1$  sphere of radius  $R = \sqrt{2mE}$ . The conditions that the  $x$ -component of the momentum of atom #1 is  $p_1$  restricts us to a circle (or rather a  $3N-2$  sphere) of radius  $R' = \sqrt{2mE - p_1^2}$ . The condition that the energy is in the shell  $(E, E + \delta E)$  leaves us with the annular region shown in the inset.

<sup>23</sup>Why is this not the surface area? Because its width is an infinitesimal energy  $\delta E$ , and not an infinitesimal thickness  $\delta R \approx \delta E(\partial R/\partial E) = \delta E(R/2E)$ . The distinction does not matter for the ideal gas (both would give uniform probability densities over all directions of  $\mathbb{P}$ ) but it is important for interacting systems (where the thickness of the energy shell varies, see Fig. 3.1).

The volume of the thin shell<sup>23</sup> between  $E$  and  $E + \delta E$  is given by

$$\begin{aligned} \frac{\text{shell volume}}{\delta E} &= \frac{\mu\left(\mathbb{S}^{\frac{3N-1}{\sqrt{2m(E+\delta E)}}}\right) - \mu\left(\mathbb{S}^{\frac{3N-1}{\sqrt{2mE}}}\right)}{\delta E} \\ &= d\mu\left(\mathbb{S}^{\frac{3N-1}{\sqrt{2mE}}}\right) / dE \\ &= \frac{d}{dE} \left( \pi^{3N/2} (2mE)^{3N/2} / (3N/2)! \right) \\ &= \pi^{3N/2} (3Nm) (2mE)^{3N/2-1} / (3N/2)! \\ &= (3Nm) \pi^{3N/2} R^{3N-2} / (3N/2)!. \end{aligned} \tag{3.14}$$

Given our microcanonical ensemble that equally weights all states with energy  $E$ , the probability density for having any particular set of particle momenta  $\mathbb{P}$  is the inverse of this shell volume.

Let us do a tangible calculation with this microcanonical ensemble. Let us calculate the probability density  $\rho(p_1)$  that the  $x$ -component of the momentum of the first atom is  $p_1$ .<sup>24</sup> The probability density that this momentum is  $p_1$  and the energy is in the range  $(E, E + \delta E)$  is proportional to the area of the annular region in Fig. 3.2. The sphere has radius  $R = \sqrt{2mE}$ , so by the Pythagorean theorem, the circle has radius  $R' = \sqrt{2mE - p_1^2}$ . The volume in momentum space of the annulus is given by the difference in areas inside the two ‘circles’ ( $3N-2$  spheres) with momentum  $p_1$  and energies  $E$  and  $E + \delta E$ . We can use eqn 3.13 with  $\ell = 3N - 1$ :

$$\begin{aligned} \frac{\text{annular area}}{\delta E} &= d\mu\left(\mathbb{S}^{\frac{3N-2}{\sqrt{2mE-p_1^2}}}\right) / dE \\ &= \frac{d}{dE} \left( \pi^{(3N-1)/2} (2mE - p_1^2)^{(3N-1)/2} / [(3N-1)/2]! \right) \\ &= \pi^{(3N-1)/2} (3N-1)m(2mE-p_1^2)^{(3N-3)/2} / [(3N-1)/2]!. \\ &= (3N-1)m\pi^{(3N-1)/2} R'^{3N-3} / [(3N-1)/2]! \end{aligned} \tag{3.15}$$

<sup>24</sup>It is a sloppy physics convention to use  $\rho$  to denote probability densities of all sorts. Earlier, we used it to denote probability density in  $3N$ -dimensional configuration space; here we use it to denote probability density in one variable. The argument of the function  $\rho$  tells us which function we are considering.

The probability density  $\rho(p_1)$  of being in the annulus at height  $p_1$  is its area divided by the shell volume in eqn 3.14:

$$\begin{aligned}\rho(p_1) &= \text{annular area} / \text{shell volume} \\ &= \frac{(3N-1)m\pi^{(3N-1)/2}R'^{3N-3}/[(3N-1)/2]!}{3Nm\pi^{3N/2}R^{3N-2}/(3N/2)!} \\ &\propto (R^2/R'^3)(R'/R)^{3N} \\ &= (R^2/R'^3)(1-p_1^2/2mE)^{3N/2}.\end{aligned}\quad (3.16)$$

The probability density  $\rho(p_1)$  will be essentially zero unless  $R'/R = \sqrt{1-p_1^2/2mE}$  is nearly equal to one, since this factor in eqn 3.16 is taken to an enormous power ( $3N$ , around Avogadro's number). We can thus simplify  $R^2/R'^3 \approx 1/R = 1/\sqrt{2mE}$  and  $1-p_1^2/2mE = 1-\epsilon \approx \exp(-\epsilon) = \exp(-p_1^2/2mE)$ , giving us

$$\rho(p_1) \propto \frac{1}{\sqrt{2mE}} \exp\left(\frac{-p_1^2}{2m} \frac{3N}{2E}\right).\quad (3.17)$$

The probability density  $\rho(p_1)$  is a Gaussian distribution of standard deviation  $\sqrt{2mE/3N}$ ; we can again set the constant of proportionality to normalize the Gaussian, leading to

$$\rho(p_1) = \frac{1}{\sqrt{2\pi m(2E/3N)}} \exp\left(\frac{-p_1^2}{2m} \frac{3N}{2E}\right).\quad (3.18)$$

This is the probability distribution for any momentum component of any of our particles; there was nothing special about particle number one. Our ensemble assumption has allowed us to calculate the momentum distribution explicitly in terms of  $E$ ,  $N$ , and  $m$ , without ever considering a particular trajectory; this is what makes statistical mechanics powerful.

Formula 3.18 tells us that most of the surface area of a large-dimensional sphere is very close to the equator! Think of  $p_1$  as the latitude on the sphere. The range of latitudes containing most of the area is  $\delta p \approx \pm\sqrt{2mE/3N}$ , and the total range of latitudes is  $\pm\sqrt{2mE}$ ; the belt divided by the height is the square root of Avogadro's number. This is true *whatever equator you choose*, even intersections of several equators. Geometry is weird in high dimensions.

In the context of statistical mechanics, this seems much less strange; typical configurations of gases have the kinetic energy divided roughly equally among all the components of momentum; configurations where one atom has most of the kinetic energy (far from its equator) are vanishingly rare.

Formula 3.18 foreshadows four key results that will emerge from our systematic study of equilibrium statistical mechanics in the following few chapters.

- (1) **Temperature.** In our calculation, a single momentum component competed for the available energy with the rest of the ideal gas. In

<sup>25</sup>We shall see that temperature is naturally measured in units of energy. Historically we measure temperature in degrees and energy in various other units (Joules, ergs, calories, eV, foot-pounds, ...); Boltzmann's constant  $k_B = 1.3807 \times 10^{-23}$  J/K is the conversion factor between units of temperature and units of energy.

<sup>26</sup>This is different from the probability of the subsystem *having* energy  $E$ , which is the product of the Boltzmann probability and the number of states with that energy.

<sup>27</sup>Molecular gases will have internal vibration modes that are often not well described by classical mechanics. At low temperatures, these are often frozen out; including rotations and translations but ignoring vibrations is a good approximation for air at room temperature (see note 13 on p. 39).

<sup>28</sup>Relativistic effects, magnetic fields, and quantum mechanics will change the velocity distribution. Equation 3.19 will be reasonably accurate for all gases at reasonable temperatures, all liquids but helium, and many solids that are not too cold. Notice that almost all molecular dynamics simulations are done classically: their momentum distributions are given by eqn 3.19.

Section 3.3 we will study the competition in general between two large subsystems for energy, and will discover that the balance is determined by the *temperature*. The temperature  $T$  for our ideal gas will be given (eqn 3.52) by  $k_B T = 2E/3N$ .<sup>25</sup> Equation 3.18 then gives us the important formula

$$\rho(p_1) = \frac{1}{\sqrt{2\pi m k_B T}} \exp\left(-\frac{p_1^2}{2m k_B T}\right). \quad (3.19)$$

- (2) **Boltzmann distribution.** The probability of the  $x$  momentum of the first particle having kinetic energy  $K = p_1^2/2m$  is proportional to  $\exp(-K/k_B T)$  (eqn 3.19). This is our first example of a *Boltzmann distribution*. We shall see in Section 6.1 that the probability of a small subsystem being in a particular state<sup>26</sup> of energy  $E$  will in completely general contexts have probability proportional to  $\exp(-E/k_B T)$ .
- (3) **Equipartition theorem.** The average kinetic energy  $\langle p_1^2/2m \rangle$  from eqn 3.19 is  $k_B T/2$ . This is an example of the *equipartition theorem* (Section 6.2): each harmonic degree of freedom in an equilibrium classical system has average energy  $k_B T/2$ .
- (4) **General classical<sup>27</sup> momentum distribution.** Our derivation was in the context of a monatomic ideal gas. But we could have done an analogous calculation for a system with several gases of different masses; our momentum sphere would become an ellipsoid, but the momentum distribution is given by the same formula. More surprising, we shall see (using the canonical ensemble in Section 6.2) that interactions do not matter either, as long as the system is classical:<sup>28</sup> the probability densities for the momenta are still given by the same formula, independent of the potential energies. The momentum distribution of formula 3.19 is correct for nearly all classical equilibrium systems; interactions will affect only the configurations of such particles, not their velocities.

### 3.3 What is temperature?

Our ordinary experience suggests that heat energy will flow from a hot body into a neighboring cold body until they reach the same temperature. Statistical mechanics insists that the distribution of heat between the two bodies is determined by the microcanonical assumption that all possible states of fixed total energy for the two bodies are equally likely. Can we make these two statements consistent? Can we define the temperature so that two large bodies in equilibrium with one another will have the same temperature?

Consider a general, isolated system of total energy  $E$  consisting of two parts, labeled 1 and 2. Each subsystem has a fixed volume and a fixed number of particles, and is energetically weakly connected to the other subsystem. The connection is weak in that we assume we can neglect



the dependence of the energy  $E_1$  of the first subsystem on the state  $s_2$  of the second one, and vice versa.<sup>29</sup>

Our microcanonical ensemble then asserts that the equilibrium behavior of the total system is an equal weighting of all possible states of the two subsystems having total energy  $E$ . A particular state of the whole system is given by a pair of states  $(s_1, s_2)$  with  $E = E_1 + E_2$ . This immediately implies that a particular configuration or state  $s_1$  of the first subsystem at energy  $E_1$  will occur with probability density<sup>30</sup>

$$\rho(s_1) \propto \Omega_2(E - E_1), \tag{3.20}$$

where  $\Omega_1(E_1) \delta E_1$  and  $\Omega_2(E_2) \delta E_2$  are the phase-space volumes of the energy shells for the two subsystems. The volume of the energy surface for the total system at energy  $E$  will be given by adding up the product of the volumes of the subsystems for pairs of energies summing to  $E$ :

$$\Omega(E) = \int dE_1 \Omega_1(E_1) \Omega_2(E - E_1), \tag{3.21}$$

as should be intuitively clear.<sup>31</sup> Notice that the integrand in eqn 3.21, normalized by the total integral, is just the probability density<sup>32</sup> for the subsystem to have energy  $E_1$ :

$$\rho(E_1) = \Omega_1(E_1) \Omega_2(E - E_1) / \Omega(E). \tag{3.23}$$

If the two subsystems have a large number of particles then it turns out<sup>33</sup> that  $\rho(E_1)$  is a very sharply peaked function near its maximum at  $E_1^*$ . Hence in equilibrium the energy in subsystem 1 is given (apart from small fluctuations) by the maximum in the integrand  $\Omega_1(E_1) \Omega_2(E - E_1)$ . The maximum is found when the derivative  $(d\Omega_1/dE_1) \Omega_2 - \Omega_1 (d\Omega_2/dE_2)$  is zero, which is where

$$\left. \frac{1}{\Omega_1} \frac{d\Omega_1}{dE_1} \right|_{E_1^*} = \left. \frac{1}{\Omega_2} \frac{d\Omega_2}{dE_2} \right|_{E - E_1^*}. \tag{3.24}$$

It is more convenient not to work with  $\Omega$ , but rather to work with its logarithm. We define the *equilibrium entropy*

$$S_{\text{equil}}(E) = k_B \log(\Omega(E)) \tag{3.25}$$

for each of our systems.<sup>34</sup> Like the total energy, volume, and number of particles, the entropy in a large system is ordinarily proportional

<sup>29</sup>A macroscopic system attached to the external world at its boundaries is usually weakly connected, since the interaction energy is only important near the surfaces, a negligible fraction of the total volume. More surprising, the momenta and configurations in a non-magnetic, non-quantum system are two uncoupled subsystems: no terms in the Hamiltonian mix them (although the dynamical evolution certainly does).

<sup>30</sup>That is, if we compare the probabilities of two states  $s_1^a$  and  $s_1^b$  of subsystem 1 with energies  $E_1^a$  and  $E_1^b$ , and if  $\Omega_2(E - E_1^a)$  is 50 times larger than  $\Omega_2(E - E_1^b)$ , then  $\rho(s_1^a) = 50 \rho(s_1^b)$  because the former has 50 times as many partners that it can pair with to get an allotment of probability.

<sup>32</sup>Warning: Again we are being sloppy; we use  $\rho(s_1)$  in eqn 3.20 for the probability density that the subsystem is in a particular state  $s_1$  and we use  $\rho(E_1)$  in eqn 3.23 for the probability density that a subsystem is in any of many particular states with energy  $E_1$ .

<sup>33</sup>Just as for the configurations of the ideal gas, where the number of particles in half the box fluctuated very little, so also the energy  $E_1$  fluctuates very little from the value  $E_1^*$  at which the probability is maximum. We will show this explicitly in Exercise 3.8, and more abstractly in note 37 below.

<sup>34</sup>Again, Boltzmann's constant  $k_B$  is a unit conversion factor with units of [energy]/[temperature]; the entropy would be unitless except for the fact that we measure temperature and energy with different scales (note 25 on p. 44).

<sup>31</sup>It is also easy to derive using the Dirac  $\delta$ -function (Exercise 3.6). We can also derive it, more awkwardly, using energy shells:

$$\begin{aligned} \Omega(E) &= \frac{1}{\delta E} \int_{E < \mathcal{H}_1 + \mathcal{H}_2 < E + \delta E} d\mathbb{P}_1 d\mathbb{Q}_1 d\mathbb{P}_2 d\mathbb{Q}_2 = \int d\mathbb{P}_1 d\mathbb{Q}_1 \left( \frac{1}{\delta E} \int_{E - \mathcal{H}_1 < \mathcal{H}_2 < E + \delta E - \mathcal{H}_1} d\mathbb{P}_2 d\mathbb{Q}_2 \right) \\ &= \int d\mathbb{P}_1 d\mathbb{Q}_1 \Omega_2(E - \mathcal{H}_1(\mathbb{P}_1, \mathbb{Q}_1)) = \sum_n \int_{n\delta E < \mathcal{H}_1 < (n+1)\delta E} d\mathbb{P}_1 d\mathbb{Q}_1 \Omega_2(E - \mathcal{H}_1(\mathbb{P}_1, \mathbb{Q}_1)) \\ &\approx \int dE_1 \left( \frac{1}{\delta E} \int_{E_1 < \mathcal{H}_1 < E_1 + \delta E} d\mathbb{P}_1 d\mathbb{Q}_1 \right) \Omega_2(E - E_1) = \int dE_1 \Omega_1(E_1) \Omega_2(E - E_1), \end{aligned} \tag{3.22}$$

where we have converted the sum to an integral  $\sum_n f(n\delta E) \approx (1/\delta E) \int dE_1 f(E_1)$ .

<sup>35</sup>We can see this by using the fact that most large systems can be decomposed into many small, weakly-coupled subsystems, for which the entropies add. (For systems with long-range forces like gravitation, breaking the system up into many weakly-coupled subsystems may not be possible, and entropy and energy need not be extensive.) This additivity of the entropy for uncoupled systems is exactly true in the canonical ensemble (Section 6.2). It is true for macroscopic systems in the microcanonical ensemble; eqn 3.28 tells us  $\Omega(E) \approx \Omega_1(E_1^*)\Omega_2(E_2^*) \int e^{-(E_1-E_1^*)^2/2\sigma_E} dE_1 = \Omega_1(E_1^*)\Omega_2(E_2^*)(\sqrt{2\pi}\sigma_E)$ , so the entropy of the total system is

$$\begin{aligned} S_{\text{tot}}(E) &= k_B \log \Omega(E) \\ &\approx S_1(E_1^*) + S_2(E - E_1^*) \\ &\quad + k_B \log(\sqrt{2\pi}\sigma_E). \end{aligned}$$

This is extensive up to the microscopic correction  $k_B \log(\sqrt{2\pi}\sigma_E)$  (due to the enhanced energy fluctuations by coupling the two subsystems).

<sup>36</sup>Entropy is a maximum rather than just an extremum because eqn 3.26 is the logarithm of the probability (eqn 3.23) expanded about a maximum.

<sup>38</sup>More correctly, one pays in negative entropy; one must accept entropy  $\delta E/T$  when buying energy  $\delta E$  from the heat bath.

to its size.<sup>35</sup> Quantities like these which scale linearly with the system size are called *extensive*. (Quantities, like the temperature, pressure, and chemical potential defined below, that stay constant as the system grows, are called *intensive*.)

Thus  $dS/dE = k_B(1/\Omega) (d\Omega/dE)$ , and eqn 3.24 simplifies to the statement

$$\frac{d}{dE_1} (S_1(E_1) + S_2(E - E_1)) = \left. \frac{dS_1}{dE_1} \right|_{E_1^*} - \left. \frac{dS_2}{dE_2} \right|_{E-E_1^*} = 0 \quad (3.26)$$

that the total entropy  $S_1 + S_2$  is maximized.<sup>36</sup> We want to define the temperature so that it becomes equal when the two subsystems come to equilibrium. We have seen that

$$\frac{dS_1}{dE_1} = \frac{dS_2}{dE_2} \quad (3.27)$$

in thermal equilibrium. As  $dS/dE$  decreases upon increasing energy, we *define the temperature* in statistical mechanics as  $1/T = dS/dE$ . We have been assuming constant volume and number of particles in our derivation; the formula for a general system is<sup>37</sup>

$$\frac{1}{T} = \left. \frac{\partial S}{\partial E} \right|_{V,N}. \quad (3.29)$$

The inverse of the temperature is the cost of buying energy from the rest of the world. The lower the temperature, the more strongly the energy is pushed downward. Entropy is the currency being paid. For each unit of energy  $\delta E$  bought, we pay  $\delta E/T = \delta E (dS/dE) = \delta S$  in reduced entropy of the outside world. Inverse temperature is the cost in entropy to buy a unit of energy.<sup>38</sup>

The ‘rest of the world’ is often called the *heat bath*; it is a source and sink for heat and fixes the temperature. All heat baths are equivalent, depending only on the temperature. More precisely, the equilibrium behavior of a system weakly coupled to the external world is independent of what the external world is made of—it depends only on the world’s temperature. This is a deep truth.

<sup>37</sup>Is the probability density  $\rho(E_1)$  sharply peaked, as we have assumed? We can Taylor expand the numerator in eqn 3.23 about the maximum  $E_1 = E_1^*$ , and use the fact that the temperatures balance at  $E_1^*$  to remove the terms linear in  $E_1 - E_1^*$ :

$$\begin{aligned} \Omega_1(E_1)\Omega_2(E - E_1) &= \exp(S_1(E_1)/k_B + S_2(E - E_1)/k_B) \\ &\approx \exp \left[ \left( S_1(E_1^*) + \frac{1}{2}(E_1 - E_1^*)^2 \frac{\partial^2 S_1}{\partial E_1^2} + S_2(E - E_1^*) + \frac{1}{2}(E_1 - E_1^*)^2 \frac{\partial^2 S_2}{\partial E_2^2} \right) / k_B \right] \\ &= \Omega_1(E_1^*)\Omega_2(E_2^*) \exp \left( (E_1 - E_1^*)^2 \left( \frac{\partial^2 S_1}{\partial E_1^2} + \frac{\partial^2 S_2}{\partial E_2^2} \right) / (2k_B) \right). \end{aligned} \quad (3.28)$$

Thus the energy fluctuations are Gaussian:  $\rho(E_1) = (1/\sqrt{2\pi}\sigma_E) e^{-(E_1-E_1^*)^2/2\sigma_E^2}$ , with standard deviation  $\sigma_E$  given by  $1/\sigma_E^2 = -(1/k_B) (\partial^2 S_1/\partial E_1^2 + \partial^2 S_2/\partial E_2^2)$ . (Note the minus sign;  $\partial^2 S/\partial E^2 = \partial(1/T)/\partial E$  is typically negative, because  $1/T$  decreases as energy increases. This is also the statement that  $S(E)$  is convex downward.) Since both  $S$  and  $E$  are extensive, they are proportional to the number of particles  $N$ , and  $\sigma_E^2 \propto 1/(\partial^2 S/\partial E^2) \propto N$  (because there is one  $S$  in the numerator and two  $E$ s in the denominator). Hence, the energy fluctuations per particle  $\sigma_E/N$  are tiny; they scale as  $1/\sqrt{N}$ . This is typical of fluctuations in statistical mechanics.

### 3.4 Pressure and chemical potential

The entropy  $S(E, V, N)$  is our first example of a *thermodynamic potential*.<sup>39</sup> In thermodynamics, all the macroscopic properties can be calculated by taking derivatives of thermodynamic potentials with respect to their arguments. It is often useful to think of thermodynamic potentials as surfaces; Fig. 3.4 shows the surface in  $S, E, V$  space (at constant number of particles  $N$ ). The energy  $E(S, V, N)$  is another thermodynamic potential, completely equivalent to  $S(E, V, N)$ ; it is the same surface with a different direction ‘up’.

In Section 3.3 we defined the temperature using  $(\partial S/\partial E)|_{V,N}$ . What about the other two first derivatives,  $(\partial S/\partial V)|_{E,N}$  and  $(\partial S/\partial N)|_{E,V}$ ? That is, how does the entropy change when volume or particles are exchanged between two subsystems? The change in the entropy for a tiny shift  $\Delta E$ ,  $\Delta V$ , and  $\Delta N$  from subsystem 2 to subsystem 1 (Fig. 3.3) is

$$\begin{aligned} \Delta S = & \left( \frac{\partial S_1}{\partial E_1} \Big|_{V,N} - \frac{\partial S_2}{\partial E_2} \Big|_{V,N} \right) \Delta E + \left( \frac{\partial S_1}{\partial V_1} \Big|_{E,N} - \frac{\partial S_2}{\partial V_2} \Big|_{E,N} \right) \Delta V \\ & + \left( \frac{\partial S_1}{\partial N_1} \Big|_{E,V} - \frac{\partial S_2}{\partial N_2} \Big|_{E,V} \right) \Delta N. \end{aligned} \quad (3.30)$$

The first term is, as before,  $(1/T_1 - 1/T_2)\Delta E$ ; exchanging energy to maximize the entropy sets the temperatures equal. Just as for the energy, if the two subsystems are allowed to exchange volume and number then the entropy will maximize itself with respect to these variables as well, with small fluctuations. Equating the derivatives with respect to volume gives us our statistical mechanics definition of the pressure  $P$ :

$$\frac{P}{T} = \frac{\partial S}{\partial V} \Big|_{E,N}, \quad (3.31)$$

and equating the derivatives with respect to number gives us the definition of the chemical potential  $\mu$ .<sup>40</sup>

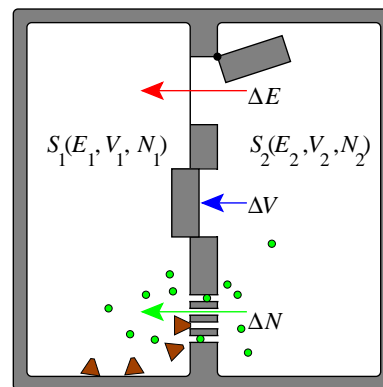
$$-\frac{\mu}{T} = \frac{\partial S}{\partial N} \Big|_{E,V}. \quad (3.32)$$

These definitions are a bit odd; usually we define pressure and chemical potential in terms of the change in energy  $E$ , not the change in entropy  $S$ . We can relate our definitions to the more usual ones using an important mathematical identity that we derive in Exercise 3.10; if  $f$  is a function of  $x$  and  $y$ , then (see Fig. 3.4)<sup>41</sup>

$$\frac{\partial f}{\partial x} \Big|_y \frac{\partial x}{\partial y} \Big|_f \frac{\partial y}{\partial f} \Big|_x = -1. \quad (3.33)$$

Remember also that if we keep all but one variable fixed, partial derivatives are like regular derivatives, so

$$\frac{\partial f}{\partial x} \Big|_y = 1 / \frac{\partial x}{\partial f} \Big|_y. \quad (3.34)$$

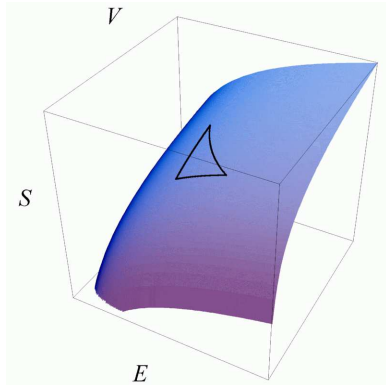


**Fig. 3.3 Two subsystems.** Two subsystems, isolated from the outside world, may exchange energy (open door through the insulation), volume (piston), or particles (tiny uncorked holes).

<sup>39</sup>Most of the other thermodynamic potentials we will use are more commonly called *free energies*.

<sup>40</sup>These relations are usually summarized in the formula  $dS = (1/T)dE + (P/T)dV - (\mu/T)dN$  (see Section 6.4).

<sup>41</sup>Notice that this is exactly minus the result you would have derived by canceling  $\partial f$ ,  $\partial x$ , and  $\partial y$  from ‘numerator’ and ‘denominator’; derivatives are almost like fractions, but not quite.



**Fig. 3.4 The surface of state.** The entropy  $S(E, V, N)$  as a function of energy  $E$  and volume  $V$  (at fixed number  $N$ ). Viewed sideways, this surface also defines the energy  $E(S, V, N)$ . The three curves are lines at constant  $S$ ,  $E$ , and  $V$ ; the fact that they must close yields the relation

$$\left. \frac{\partial S}{\partial E} \right|_{V,N} \left. \frac{\partial E}{\partial V} \right|_{S,N} \left. \frac{\partial V}{\partial S} \right|_{E,N} = -1$$

(see Exercise 3.10).

<sup>42</sup>We do have experience with the chemical potential of one gas. Our lungs exchange carbon dioxide for oxygen. A high chemical potential for  $\text{CO}_2$  in the blood causes us to breathe hard.

Using this for  $S(E, V)$  and fixing  $N$ , we find

$$-1 = \left. \frac{\partial S}{\partial V} \right|_{E,N} \left. \frac{\partial V}{\partial E} \right|_{S,N} \left. \frac{\partial E}{\partial S} \right|_{V,N} = \frac{P}{T} \left( 1 / \left. \frac{\partial E}{\partial V} \right|_{S,N} \right) T, \quad (3.35)$$

so

$$\left. \frac{\partial E}{\partial V} \right|_{S,N} = -P. \quad (3.36)$$

Thus the pressure is minus the energy cost per unit volume at constant entropy. Similarly,

$$-1 = \left. \frac{\partial S}{\partial N} \right|_{E,V} \left. \frac{\partial N}{\partial E} \right|_{S,V} \left. \frac{\partial E}{\partial S} \right|_{N,V} = -\frac{\mu}{T} \left( 1 / \left. \frac{\partial E}{\partial N} \right|_{S,V} \right) T, \quad (3.37)$$

so

$$\left. \frac{\partial E}{\partial N} \right|_{S,V} = \mu; \quad (3.38)$$

the chemical potential is the energy cost of adding a particle at constant entropy.

The chemical potential will be unfamiliar to most of those new to statistical mechanics. We can feel pressure and temperature as our bodies exchange volume with balloons and heat with coffee cups. Most of us have not had comparable tactile experience with exchanging particles.<sup>42</sup> You can view chemical potential as a ‘force’ associated with particle number, in the same spirit as pressure is a force associated with volume and temperature is a ‘force’ associated with energy; differences in  $\mu$ ,  $P$ , and  $T$  will induce transfers of particles, volume, or energy from one subsystem into another. Chemical potentials are crucial to the study of chemical reactions; whether a reaction will proceed depends in part on the relative cost of the products and the reactants, measured by the differences in their chemical potentials (Section 6.6). They drive the osmotic pressure that holds your cell membranes taut. The chemical potential will also play a central role in calculations involving non-interacting quantum systems, where the number of particles in each quantum state can vary (Chapter 7). Your intuition about chemical potentials will improve as you work with them.

### 3.4.1 Advanced topic: pressure in mechanics and statistical mechanics.

Our familiar notion of pressure is from mechanics: the energy of a subsystem increases as the volume decreases, as  $\Delta E = -P\Delta V$ . Our statistical mechanics definition ( $P = -(\partial E/\partial V)|_{S,N}$ , eqn 3.36) states that this energy change is measured at fixed entropy—which may not be so familiar.

Not all mechanical volume changes are acceptable for measuring the pressure. A mechanical measurement of the pressure must not exchange heat with the body. (Changing the volume while adding heat to keep the temperature fixed, for example, is a different measurement.) The

mechanical measurement must also change the volume slowly. If the volume changes fast enough that the subsystem goes out of equilibrium (typically a piston moving near the speed of sound), then the energy needed to change the volume will include the energy for generating the sound and shock waves—energies that are not appropriate to include in a good measurement of the pressure. We call a process *adiabatic* if it occurs without heat exchange and sufficiently slowly that the system remains in equilibrium.

In this section we will show in a microcanonical ensemble that the mechanical definition of the pressure (the rate of change in average internal energy as one slowly varies the volume,  $P_m = -\Delta E/\Delta V$ ) equals the statistical mechanical definition of the pressure ( $P_{\text{stat}} = T(\partial S/\partial V)|_{E,N} = -(\partial E/\partial V)|_{S,N}$ , eqns 3.31 and 3.36). Hence, an adiabatic measurement of the pressure is done at constant entropy.

The argument is somewhat technical and abstract, using methods that will not be needed in the remainder of the text. Why is this question important, beyond justifying our definition of pressure? In Chapter 5, the entropy will become our fundamental measure of irreversibility. Since the system remains in equilibrium under adiabatic changes in the volume, its entropy should not change.<sup>43</sup> Our arguments there will work backward from the macroscopic principle that perpetual motion machines should not exist. Our argument here works forward from the microscopic laws, showing that systems that stay in equilibrium (changed adiabatically, thermally isolated and slowly varying) are consistent with a constant entropy.<sup>44</sup>

We must first use statistical mechanics to find a formula for the mechanical force per unit area  $P_m$ . Consider some general liquid or gas whose volume is changed smoothly from  $V$  to  $V + \Delta V$ , and is otherwise isolated from the rest of the world.

We can find the mechanical pressure if we can find out how much the energy changes as the volume changes. The initial system at  $t = 0$  is an microcanonical ensemble at volume  $V$ , uniformly filling phase space in an energy range  $E < \mathcal{H} < E + \delta E$  with density  $1/\Omega(E, V)$ . A member of this volume-expanding ensemble is a trajectory  $\mathbb{P}(t), \mathbb{Q}(t)$  that evolves in time under the changing Hamiltonian  $\mathcal{H}(\mathbb{P}, \mathbb{Q}, V(t))$ . The amount this particular trajectory changes in energy under the time-dependent Hamiltonian is

$$\frac{d\mathcal{H}(\mathbb{P}(t), \mathbb{Q}(t), V(t))}{dt} = \frac{\partial \mathcal{H}}{\partial \mathbb{P}} \dot{\mathbb{P}} + \frac{\partial \mathcal{H}}{\partial \mathbb{Q}} \dot{\mathbb{Q}} + \frac{\partial \mathcal{H}}{\partial V} \frac{dV}{dt}. \quad (3.39)$$

A Hamiltonian for particles of kinetic energy  $\frac{1}{2}P^2/m$  and potential energy  $U(Q)$  will have  $\partial \mathcal{H}/\partial \mathbb{P} = \mathbb{P}/m = \dot{\mathbb{Q}}$  and  $\partial \mathcal{H}/\partial \mathbb{Q} = \partial U/\partial \mathbb{Q} = -\dot{\mathbb{P}}$ , so the first two terms cancel on the right-hand side of eqn 3.39.<sup>45</sup> Hence the energy change for this particular trajectory is

$$\frac{d\mathcal{H}(\mathbb{P}(t), \mathbb{Q}(t), V(t))}{dt} = \frac{\partial \mathcal{H}}{\partial V}(\mathbb{P}, \mathbb{Q}) \frac{dV}{dt}. \quad (3.40)$$

That is, the energy change of the evolving trajectory is the same as the

<sup>43</sup>It is the entropy of the entire system, including the mechanical instrument that changes the volume, that cannot decrease. We're using the fact that instrument can be made with few moving parts that couple to our system; the entropy of a system with only a few degrees of freedom can be neglected. (You will notice that the entropy is always  $Nk_B$  times a logarithm. The logarithm is an extremely slowly varying function, so the entropy is always a reasonably small constant times  $N$  times  $k_B$ . If a system has only a few moving parts  $N$ , its entropy is only a few  $k_B$ —hence tiny.)

<sup>44</sup>Our argument will not use the fact that the parameter  $V$  is the volume. Any adiabatic change in the system happens at constant entropy.

<sup>45</sup>Some may recognize these as Hamilton's equations of motion: the cancellation works for general Hamiltonian systems, even those not of the standard Newtonian form.

expectation value of  $\partial\mathcal{H}/\partial t$  at the static current point in the trajectory: we need not follow the particles as they zoom around.

We still must average this energy change over the equilibrium ensemble of initial conditions. This is in general not possible, until we make the second assumption involved in the adiabatic measurement of pressure: we assume that the potential energy turns on so slowly that the system remains in equilibrium at the current volume  $V(t)$  and energy  $E(t)$ . This allows us to calculate the ensemble average energy change in terms of an equilibrium average at the fixed, current volume:

$$\frac{d\langle\mathcal{H}\rangle}{dt} = \left\langle \frac{\partial\mathcal{H}}{\partial V} \right\rangle_{E(t),V(t)} \frac{dV}{dt}. \quad (3.41)$$

Since this energy change must equal  $-P_m(dV/dt)$ , we find (eqn 3.4):

$$-P_m = \left\langle \frac{\partial\mathcal{H}}{\partial V} \right\rangle = \frac{1}{\Omega(E)} \int d\mathbb{P} d\mathbb{Q} \delta(E - \mathcal{H}(\mathbb{P}, \mathbb{Q}, V)) \frac{\partial\mathcal{H}}{\partial V}. \quad (3.42)$$

We now turn to calculating the derivative of interest for the statistical mechanical definition of pressure:

$$\left. \frac{\partial S}{\partial V} \right|_{E,N} = \left. \frac{\partial}{\partial V} k_B \log(\Omega) \right|_{E,N} = \frac{k_B}{\Omega} \left. \frac{\partial\Omega}{\partial V} \right|_{E,N}. \quad (3.43)$$

Using eqn 3.2 to write  $\Omega$  in terms of a derivative of the  $\Theta$  function, we can change orders of differentiation:

$$\begin{aligned} \left. \frac{\partial\Omega}{\partial V} \right|_{E,N} &= \left. \frac{\partial}{\partial V} \right|_{E,N} \left. \frac{\partial}{\partial E} \right|_{V,N} \int d\mathbb{P} d\mathbb{Q} \Theta(E - \mathcal{H}(\mathbb{P}, \mathbb{Q}, V)) \\ &= \left. \frac{\partial}{\partial E} \right|_{V,N} \int d\mathbb{P} d\mathbb{Q} \frac{\partial}{\partial V} \Theta(E - \mathcal{H}(\mathbb{P}, \mathbb{Q}, V)) \\ &= - \left. \frac{\partial}{\partial E} \right|_{V,N} \int d\mathbb{P} d\mathbb{Q} \delta(E - \mathcal{H}(\mathbb{P}, \mathbb{Q}, V)) \frac{\partial\mathcal{H}}{\partial V}. \end{aligned} \quad (3.44)$$

But the phase-space integral in the last equation is precisely the same integral that appears in our mechanical formula for the pressure, eqn 3.42: it is  $\Omega(E)(-P_m)$ . Thus

$$\begin{aligned} \left. \frac{\partial\Omega}{\partial V} \right|_{E,N} &= \left. \frac{\partial}{\partial E} \right|_{V,N} (\Omega(E)P_m) \\ &= \left. \frac{\partial\Omega}{\partial E} \right|_{V,N} P_m + \Omega \left. \frac{\partial P_m}{\partial E} \right|_{V,N}, \end{aligned} \quad (3.45)$$

so

$$\begin{aligned} \left. \frac{\partial S}{\partial V} \right|_{E,N} &= \left. \frac{\partial}{\partial V} k_B \log(\Omega) \right|_{E,N} = \frac{k_B}{\Omega} \left( \left. \frac{\partial\Omega}{\partial E} \right|_{V,N} P_m + \Omega \left. \frac{\partial P_m}{\partial E} \right|_{V,N} \right) \\ &= \left. \frac{\partial k_B \log(\Omega)}{\partial E} \right|_{V,N} P_m + k_B \left. \frac{\partial P_m}{\partial E} \right|_{V,N} \\ &= \left. \frac{\partial S}{\partial E} \right|_{V,N} P_m + k_B \left. \frac{\partial P_m}{\partial E} \right|_{V,N} = \frac{P_m}{T} + k_B \left. \frac{\partial P_m}{\partial E} \right|_{V,N}. \end{aligned} \quad (3.46)$$

Now,  $P$  and  $T$  are both intensive variables, but  $E$  is extensive (scales linearly with system size). Hence  $P/T$  is of order one for a large system, but  $k_B(\partial P/\partial E)$  is of order  $1/N$  where  $N$  is the number of particles. (For example, we shall see that for the ideal gas,  $PV = \frac{2}{3}E = Nk_B T$ , so  $k_B(\partial P/\partial E) = 2k_B/3V = 2P/3NT = 2P/3NT \ll P/T$  for large  $N$ .) Hence the second term, for a large system, may be neglected, giving us the desired relation:

$$\left. \frac{\partial S}{\partial V} \right|_{E,N} = \frac{P_m}{T}. \quad (3.47)$$

The derivative of the entropy  $S(E, V, N)$  with respect to  $V$  at constant  $E$  and  $N$  is thus indeed the mechanical pressure divided by the temperature.

### 3.5 Entropy, the ideal gas, and phase-space refinements

Let us find the temperature and pressure for the ideal gas, using our microcanonical ensemble. We will then introduce two subtle refinements to the phase-space volume (one from quantum mechanics, and one for undistinguished particles) which will not affect the temperature or pressure, but will be important for the entropy and chemical potential.

We derived the volume  $\Omega(E)$  of the energy shell in phase space in Section 3.2; it factored<sup>46</sup> into a momentum-shell volume from eqn 3.14 and a configuration-space volume  $V^N$ . Before our refinements, we have

$$\begin{aligned} \Omega_{\text{crude}}(E) &= V^N \left( \frac{3N}{2E} \right) \pi^{3N/2} (2mE)^{3N/2} / (3N/2)! \\ &\approx V^N \pi^{3N/2} (2mE)^{3N/2} / (3N/2)!. \end{aligned} \quad (3.48)$$

Notice that in the second line of eqn 3.48 we have dropped the term  $3N/2E$ ; it divides the phase-space volume by a negligible factor (two-thirds the energy per particle).<sup>47</sup> The entropy and its derivatives are (before our refinements)

$$\begin{aligned} S_{\text{crude}}(E) &= k_B \log \left( V^N \pi^{3N/2} (2mE)^{3N/2} / (3N/2)! \right) \\ &= Nk_B \log(V) + \frac{3Nk_B}{2} \log(2\pi mE) - k_B \log[(3N/2)!], \end{aligned} \quad (3.49)$$

$$\frac{1}{T} = \left. \frac{\partial S}{\partial E} \right|_{V,N} = \frac{3Nk_B}{2E}, \quad (3.50)$$

$$\frac{P}{T} = \left. \frac{\partial S}{\partial V} \right|_{E,N} = \frac{Nk_B}{V}, \quad (3.51)$$

so the temperature and pressure are given by

$$k_B T = \frac{2E}{3N}, \quad (3.52)$$

$$PV = Nk_B T. \quad (3.53)$$

<sup>46</sup>It factors only because the potential energy is zero.

<sup>47</sup>Multiplying  $\Omega(E)$  by a factor independent of the number of particles is equivalent to adding a constant to the entropy. The entropy of a typical system is so large (of order Avogadro's number times  $k_B$ ) that adding a number-independent constant to it is irrelevant. Notice that this implies that  $\Omega(E)$  is so large that *multiplying* it by a constant does not significantly change its value (Exercise 3.2).

The first line above is the temperature formula we promised in forming eqn 3.19; velocity components of the particles in an ideal gas each have average energy equal to  $\frac{1}{2}k_B T$ .

<sup>48</sup>It is rare that the ‘equation of state’ can be written out as an explicit equation! Only in special cases (e.g., non-interacting systems like the ideal gas) can one solve in closed form for the thermodynamic potentials, equations of state, or other properties.

The second formula is the *equation of state*<sup>48</sup> for the ideal gas. The equation of state is the relation between the macroscopic variables of an equilibrium system that emerges in the limit of large numbers of particles. The force per unit area on the wall of an ideal gas will fluctuate in time around the pressure  $P(T, V, N) = Nk_B T/V$  given by the equation of state, with the magnitude of the fluctuations vanishing as the system size gets large.

In general, our definition for the energy-shell volume in phase space needs two refinements. First, the phase-space volume has dimensions of  $([\text{length}][\text{momentum}])^{3N}$ ; the volume of the energy shell depends multiplicatively upon the units chosen for length, mass, and time. Changing these units will change the corresponding crude form for the entropy by adding a constant times  $3N$ . Most physical properties, like temperature and pressure above, are dependent only on derivatives of the entropy, so the overall constant will not matter; indeed, the zero of the entropy is undefined within classical mechanics. It is suggestive that  $[\text{length}][\text{momentum}]$  has units of Planck’s constant  $h$ , and we shall see in Chapter 7 that quantum mechanics in fact does set the zero of the entropy. We shall see in Exercise 7.3 that dividing<sup>49</sup>  $\Omega(E)$  by  $h^{3N}$  nicely sets the entropy density to zero in equilibrium quantum systems at absolute zero.

<sup>49</sup>This is equivalent to using units for which  $h = 1$ .

Second, there is an important subtlety in quantum physics regarding *identical* particles. Two electrons, or two helium atoms of the same isotope, are not just hard to tell apart; they really are completely and utterly the same (Fig. 7.3). We shall see in Section 7.3 that the proper quantum treatment of identical particles involves averaging over possible states using Bose and Fermi statistics.

In classical physics, there is an analogous subtlety regarding *undistinguished* particles. Undistinguished classical particles include the case of identical (indistinguishable) particles at high temperatures, where the Bose and Fermi statistics become unimportant (Chapter 7). We use the term ‘undistinguished’ to also describe particles which in principle are not identical, but for which our Hamiltonian and measurement instruments treat identically (pollen grains and colloidal particles, for example). For a system of two undistinguished particles, the phase-space points  $(\mathbf{p}_A, \mathbf{p}_B, \mathbf{q}_A, \mathbf{q}_B)$  and  $(\mathbf{p}_B, \mathbf{p}_A, \mathbf{q}_B, \mathbf{q}_A)$  should not both be counted; the volume of phase space  $\Omega(E)$  should be half that given by a calculation for distinguished particles. For  $N$  undistinguished particles, the phase-space volume should be divided by  $N!$ , the total number of ways the labels for the particles can be permuted.<sup>50</sup>

<sup>50</sup>This  $N!$  is sometimes known as the *Gibbs factor*.

Unlike the introduction of the factor  $h^{3N}$  above, dividing the phase-space volume by  $N!$  does change the predictions of classical statistical mechanics in important ways. We will see in Section 5.2.1 that the entropy increase for joining containers of different kinds of particles should



be substantial, while the entropy increase for joining containers filled with undistinguished particles should be near zero. This result is correctly treated by dividing  $\Omega(E)$  by  $N!$  for each set of  $N$  undistinguished particles. We call the resulting ensemble *Maxwell–Boltzmann* statistics, to distinguish it from distinguishable statistics and from the quantum-mechanical Bose and Fermi statistics.

Combining these two refinements gives us the proper energy-shell volume for classical undistinguished particles, replacing eqn 3.5:<sup>51</sup>

$$\Omega(E) = \int_{E < \mathcal{H}(\mathbb{P}, \mathbb{Q}) < E + \delta E} \frac{d\mathbb{P} d\mathbb{Q}}{N! h^{3N}}. \quad (3.54)$$

For the ideal gas, this refines  $\Omega_{\text{crude}}$  of eqn 3.48 to

$$\Omega(E) = (V^N / N!) (\pi^{3N/2} (2mE)^{3N/2} / (3N/2)!) (1/h)^{3N}, \quad (3.55)$$

$$S(E) = Nk_B \log \left[ \frac{V}{h^3} (2\pi mE)^{3/2} \right] - k_B \log [N! (3N/2)!]. \quad (3.56)$$

We can make our equation for the ideal gas entropy more useful by using Stirling's formula  $\log(N!) \approx N \log N - N$ , valid at large  $N$ :

$$S(E, V, N) = \frac{5}{2} Nk_B + Nk_B \log \left[ \frac{V}{Nh^3} \left( \frac{4\pi mE}{3N} \right)^{3/2} \right]. \quad (3.57)$$

This is the standard formula for the entropy of an ideal gas. We can put it into a somewhat simpler form by writing it in terms of the particle density  $\rho = N/V$ :

$$S = Nk_B \left( \frac{5}{2} - \log(\rho \lambda^3) \right), \quad (3.58)$$

where<sup>52</sup>

$$\lambda = h / \sqrt{4\pi mE / 3N} \quad (3.59)$$

is called the *thermal de Broglie wavelength*, and will be physically significant for quantum systems at low temperature (Chapter 7).

<sup>51</sup>Note that we also have dropped  $\delta E$  from the left-hand side. Just as in eqn 3.48 where we dropped a factor of  $3N/2E$  for the ideal gas to simplify the formulas (e.g., making the entropy extensive), one factor of  $\delta E$  is negligible when the number of particles  $N$  is large (see note 47).

<sup>52</sup>De Broglie realized that matter could act as a wave; a particle of momentum  $p$  had a wavelength  $\lambda_{\text{quantum}} = h/p$ . The mean square of one component of momentum in our gas is  $p^2 = 2m(E/3N)$ , so our particles have a quantum wavelength of  $h/\sqrt{2mE/3N} = \sqrt{2\pi} \lambda_{\text{thermal}}$ —close enough that we give de Broglie's name to  $\lambda$  too.

## Exercises

It is fun to notice the large and small numbers that show up in statistical mechanics. We explore these in *Temperature and energy* and *Large and very large numbers*.

*Escape velocity* explores why the Earth is not a gas giant like Jupiter. *Pressure* provides a concrete derivation of the pressure for the ideal gas, directly from a simulation of the molecular impacts on a surface. *Hard sphere gas* provides the next step beyond the ideal gas law.

The next four exercises explore the statistics and fluctuations of weakly-coupled systems. *Connecting two macroscopic systems* illustrates the utility of  $\delta$ -functions in deriving the product law for the phase-space energy-shell volume. *Gas mixture*, and *Microcanonical energy fluctuations* show that the energy fluctuations are tiny, first specifically and then in general. *Gauss and Poisson* explores the dependence of these fluctuations on the

outside world.

*Triple product relation*, and *Maxwell relations* introduce some of the tricky partial derivative relations in thermodynamics. Finally, *Solving differential equations: the pendulum* introduces the numerical methods used in molecular dynamics, which can be used to simulate more realistic gases (and liquids and solids), emphasizing the three themes of accuracy, stability, and fidelity.

(3.1) **Temperature and energy.** ①

What units [joules, millijoules, microjoules, nanojoules, . . . , zeptojoules ( $10^{-21}$  joules), yoctojoules ( $10^{-24}$  joules)] would we use to measure temperature if we used energy units instead of introducing Boltzmann's constant  $k_B = 1.3807 \times 10^{-23}$  J/K?

(3.2) **Large and very large numbers.** ①

The numbers that arise in statistical mechanics can defeat your calculator. A googol is  $10^{100}$  (one with a hundred zeros after it). A googolplex is  $10^{\text{googol}}$ .

Consider a monatomic ideal gas with one mole of particles ( $N = \text{Avogadro's number}$ ,  $6.02 \times 10^{23}$ ), room temperature  $T = 300$  K, and volume  $V = 22.4$  liters (corresponding to atmospheric pressure).

(a) Which of the properties ( $S$ ,  $T$ ,  $E$ , and  $\Omega(E)$ ) of our gas sample are larger than a googol? A googolplex? Does it matter what units you use, within reason?

Some properties of the gas are intensive (independent of  $N$  for large  $N$ ), some are extensive (proportional to  $N$ ), and some grow even faster with  $N$ .

(b) Which category (intensive, extensive, faster) does each of the properties from part (a) belong to?

(3.3) **Escape velocity.** ②

The molecules in planetary atmospheres are slowly leaking into interstellar space. The trajectory of each molecule is a random walk, with a step size that grows with height as the air becomes more dilute. Let us consider a crude ideal gas model for this leakage, with no collisions except with the ground.

For this exercise, treat diatomic oxygen as a monatomic ideal gas with twice the mass of an oxygen atom  $m_{\text{O}_2} = 2m_{\text{O}}$ . (This is not

an approximation; the rotations and vibrations do not affect the center-of-mass trajectory.) Assume that the probability distribution for the  $z$ -component of momentum<sup>53</sup> is that of the ideal gas, given in eqn 3.19:  $\rho(p_z) = 1/\sqrt{2\pi mk_B T} \exp(-p_z^2/2mk_B T)$ . For your convenience,  $k_B = 1.3807 \times 10^{-16}$  erg/K,  $m_{\text{O}_2} = 5.3 \times 10^{-23}$  g, and  $T = 300$  K.

(a) What is the root-mean-square (RMS) vertical velocity  $\sqrt{\langle v_z^2 \rangle}$  of an  $\text{O}_2$  molecule? If a collisionless molecule started at the Earth's surface with this RMS vertical velocity, how high would it reach? How long before it hit the ground? (Useful constant:  $g = 980$  cm/s<sup>2</sup>.)

(b) Give the probability that an  $\text{O}_2$  molecule will have a vertical component of the velocity greater than Earth's escape velocity (about 11 km/s).

(Hint:  $\int_x^\infty e^{-t^2} dt \approx e^{-x^2}/2x$  for large  $x$ .)

(c) If we assume that the molecules do not collide with one another, and each thermalizes its velocity each time it collides with the ground (at roughly the time interval from part (a)), about what fraction of the oxygen molecules will we lose per year? Do we need to worry about losing our atmosphere? (It is useful to know that these happen to be about  $\pi \times 10^7$  seconds in a year.) Try this for  $\text{H}_2$ , using  $T = 1000$  K (the temperature in the upper atmosphere where the last collision occurs). Is this why Jupiter has a hydrogen atmosphere, and Earth does not?

(3.4) **Pressure computation.**<sup>54</sup> (Computation) ②

Microscopically, pressure comes from atomic collisions onto a surface. Let us calculate this microscopic pressure for an ideal gas, both analytically and using a molecular dynamics simulation. You may download our molecular dynamics software [10] from the text web site [129].

Run a simulation of the ideal gas in a system with reflective walls. Each time an atom collides with a wall, it undergoes *specular reflection*, with the parallel momentum components unchanged and the perpendicular momentum component reversed.

(a) Remembering that pressure  $P = F/A$  is the force per unit area, and that force  $F = dp/dt = (\sum \Delta P)/\Delta t$  is the net rate of momentum per unit time. Suppose a wall of area  $A$  at  $x = L$  is holding atoms to values  $x < L$  inside a box. Write a formula for the pressure in terms of

<sup>53</sup>That is, we ignore wind and the rotation of the Earth.

<sup>54</sup>This exercise and the associated software were developed in collaboration with Christopher Myers.

$\rho_c(p_x)$ , the expected number of collisions at that wall per unit time with incoming momentum  $p_x$ . (Hint: Check the factors of two, and limits of your integral. Do negative momenta contribute?)

The simulation provides an ‘observer’, which records the magnitudes of all impacts on a wall during a given time interval.

(b) Make a histogram of the number of impacts on the wall during an interval  $\Delta t$  with momentum transfer  $\Delta p$ . By what factor must you multiply  $\rho_c(p_x)$  from part (a) to get this histogram? Unlike the distribution of momenta in the gas, the probability  $\rho_c(p_x)$  of a wall collision with momentum  $p_x$  goes to zero as  $p_x$  goes to zero; the ideal gas atoms which are not moving do not collide with walls. The density of particles of momentum  $p_x$  per unit volume per unit momentum is the total density of particles  $N/V$  times the probability that a particle will have momentum  $p_x$  (eqn 3.19):

$$\frac{N}{V} \frac{1}{\sqrt{2\pi mk_B T}} \exp\left(-\frac{p_x^2}{2mk_B T}\right). \quad (3.60)$$

(c) In a time  $\Delta t$ , from how far away will atoms of incoming momentum  $p_x$  collide with the wall? What should the resulting formula be for  $\rho_c(p_x)$ ? Does it agree with your histogram of part (b)? What is your resulting equation for the pressure  $P$ ? Does it agree with the ideal gas law?

(3.5) **Hard sphere gas.** ②

We can improve on the realism of the ideal gas by giving the atoms a small radius. If we make the potential energy infinite inside this radius (*hard spheres*), the potential energy is simple (zero unless the spheres overlap, which is forbidden). Let us do this in two dimensions; three dimensions is no more complicated, but slightly harder to visualize.

A two-dimensional  $L \times L$  box with hard walls contains a gas of  $N$  hard disks of radius  $r \ll L$  (Fig. 3.5). The disks are dilute; the summed area  $N\pi r^2 \ll L^2$ . Let  $A$  be the effective area allowed for the disks in the box (Fig. 3.5):  $A = (L - 2r)^2$ .

(a) The area allowed for the second disk is  $A - \pi(2r)^2$  (Fig. 3.6), ignoring the small correction when the excluded region around the first disk overlaps the excluded region near the walls of the box. What is the allowed  $2N$ -dimensional volume in configuration space, of allowed zero-energy configurations of hard disks, in this di-

lute limit? Ignore small corrections when the excluded region around one disk overlaps the excluded regions around other disks, or near the walls of the box. Remember the  $1/N!$  correction for identical particles. Leave your answer as a product of  $N$  terms.

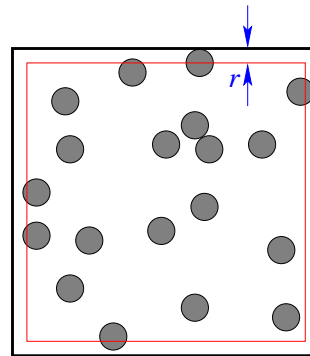


Fig. 3.5 Hard sphere gas.

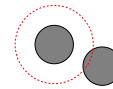


Fig. 3.6 Excluded area around a hard disk.

(b) What is the configurational entropy for the hard disks? Here, simplify your answer so that it does not involve a sum over  $N$  terms, but valid to first order in the area of the disks  $\pi r^2$ . Show, for large  $N$ , that it is well approximated by  $S_Q = Nk_B(1 + \log(A/N - b))$ , with  $b$  representing the effective excluded area due to the other disks. (You may want to derive the formula  $\sum_{n=1}^N \log(A - (n-1)\epsilon) = N \log(A - (N-1)\epsilon/2) + O(\epsilon^2)$ .) What is the value of  $b$ , in terms of the area of the disk?

(c) Find the pressure for the hard-disk gas in the large  $N$  approximation of part (b). Does it reduce to the ideal gas law for  $b = 0$ ?

(3.6) **Connecting two macroscopic systems.** ③

An isolated system with energy  $E$  is composed of two macroscopic subsystems, each of fixed volume  $V$  and number of particles  $N$ . The subsystems are weakly coupled, so the sum of their energies is  $E_1 + E_2 = E$  (Fig. 3.3 with only the

energy door open). ) We can use the Dirac delta-function  $\delta(x)$  (note 4 on p. 6) to define the volume of the energy surface of a system with Hamiltonian  $\mathcal{H}$ :

$$\begin{aligned} \Omega(E) &= \int \frac{d\mathbb{P} d\mathbb{Q}}{h^{3N}} \delta(E - \mathcal{H}(\mathbb{P}, \mathbb{Q})) \quad (3.61) \\ &= \int \frac{d\mathbb{P}_1 d\mathbb{Q}_1}{h^{3N_1}} \frac{d\mathbb{P}_2 d\mathbb{Q}_2}{h^{3N_2}} \\ &\quad \times \delta(E - (\mathcal{H}_1(\mathbb{P}_1, \mathbb{Q}_1) + \mathcal{H}_2(\mathbb{P}_2, \mathbb{Q}_2))). \end{aligned} \quad (3.62)$$

Derive formula 3.21,  $\Omega(E) = \int dE_1 \Omega_1(E_1)\Omega_2(E - E_1)$ , for the volume of the energy surface of the whole system using Dirac  $\delta$ -functions (instead of using energy shells, as in eqn 3.22). (Hint: Insert  $\int \delta(E_1 - \mathcal{H}_1(\mathbb{P}_1, \mathbb{Q}_1)) dE_1 = 1$  into eqn 3.62.)

(3.7) **Gas mixture.** ③

Consider a monatomic gas (He) mixed with a diatomic gas ( $H_2$ ). We approximate both as ideal gases, so we may treat the helium gas as a separate system, weakly coupled to the hydrogen gas (despite the intermingling of the two gases in space). We showed that a monatomic ideal gas of  $N$  atoms has  $\Omega_1(E_1) \propto E_1^{3N/2}$ . A diatomic molecule has  $\Omega_2(E_2) \propto E_2^{5N/2}$ .<sup>55</sup>

(a) Calculate the probability density of system 1 being at energy  $E_1$  (eqn 3.23). For these two gases, which energy  $E_1^{\max}$  has the maximum probability?

(b) Approximate your answer to part (a) as a Gaussian, by expanding the logarithm in a Taylor series  $\log(\rho(E_1)) \approx \log(\rho(E_1^{\max})) + (E_1 - E_1^{\max}) + \dots$  up to second derivatives, and then re-exponentiating. In this approximation, what is the mean energy  $\langle E_1 \rangle$ ? What are the energy fluctuations per particle  $\sqrt{\langle (E_1 - E_1^{\max})^2 \rangle} / N$ ? Are they indeed tiny (proportional to  $1/\sqrt{N}$ )?

For subsystems with large numbers of particles  $N$ , temperature and energy density are well defined because  $\Omega(E)$  for each subsystem grows extremely rapidly with increasing energy, in such a way that  $\Omega_1(E_1)\Omega_2(E - E_1)$  is sharply peaked near its maximum.

(3.8) **Microcanonical energy fluctuations.** ②

We argued in Section 3.3 that the energy fluctuations between two weakly-coupled subsystems are of order  $\sqrt{N}$ . Let us calculate them explicitly.

Equation 3.28 showed that for two subsystems with energy  $E_1$  and  $E_2 = E - E_1$  the probability density of  $E_1$  is a Gaussian with variance (standard deviation squared):

$$\sigma_{E_1}^2 = -k_B / (\partial^2 S_1 / \partial E_1^2 + \partial^2 S_2 / \partial E_2^2). \quad (3.63)$$

(a) Show that

$$\frac{1}{k_B} \frac{\partial^2 S}{\partial E^2} = -\frac{1}{k_B T} \frac{1}{N c_v T}, \quad (3.64)$$

where  $c_v$  is the inverse of the total specific heat at constant volume. (The specific heat  $c_v$  is the energy needed per particle to change the temperature by one unit:  $N c_v = (\partial E / \partial T)|_{V, N}$ .)

The denominator of eqn 3.64 is the product of two energies. The second term  $N c_v T$  is a system-scale energy; it is the total energy that would be needed to raise the temperature of the system from absolute zero, if the specific heat per particle  $c_v$  were temperature independent. However, the first energy,  $k_B T$ , is an atomic-scale energy independent of  $N$ . The fluctuations in energy, therefore, scale like the geometric mean of the two, summed over the two subsystems in eqn 3.28, and hence scale as  $\sqrt{N}$ ; the total energy fluctuations per particle are thus roughly  $1/\sqrt{N}$  times a typical energy per particle.

This formula is quite remarkable; it is a fluctuation-response relation (see Section 10.7). Normally, to measure a specific heat one would add a small energy and watch the temperature change. This formula allows us to measure the specific heat of an object by watching the equilibrium fluctuations in the energy. These fluctuations are tiny for the sample sizes in typical experiments, but can be quite substantial in computer simulations.

(b) If  $c_v^{(1)}$  and  $c_v^{(2)}$  are the specific heats per particle for two subsystems of  $N$  particles each, show using eqns 3.63 and 3.64 that

$$\frac{1}{c_v^{(1)}} + \frac{1}{c_v^{(2)}} = \frac{N k_B T^2}{\sigma_{E_1}^2}. \quad (3.65)$$

We do not even need to couple two systems. The positions and momenta of a molecular dynamics simulation (atoms moving under Newton's laws of motion) can be thought of as two uncoupled subsystems, since the kinetic energy does not depend on the configuration  $\mathbb{Q}$ , and the potential energy does not depend on the momenta  $\mathbb{P}$ .

<sup>55</sup>This is true in the range  $\hbar^2/2I \ll k_B T \ll \hbar\omega$ , where  $\omega$  is the vibrational frequency of the stretch mode and  $I$  is the moment of inertia. The lower limit makes the rotations classical; the upper limit freezes out the vibrations, leaving us with three classical translation modes and two rotational modes—a total of five degrees of freedom.

Assume a molecular dynamics simulation of  $N$  interacting particles has measured the kinetic energy as a function of time in an equilibrium, constant-energy simulation,<sup>56</sup> and has found a mean kinetic energy  $K = \langle E_1 \rangle$  and a standard deviation  $\sigma_K$ .

(c) Using the equipartition theorem, write the temperature in terms of  $K$ . Show that  $c_v^{(1)} = 3k_B/2$  for the momentum degrees of freedom. In terms of  $K$  and  $\sigma_K$ , solve for the total specific heat of the molecular dynamics simulation (configurational plus kinetic).

(3.9) **Gauss and Poisson.** ②

The deep truth underlying equilibrium statistical mechanics is that the behavior of large, weakly-coupled systems is largely independent of their environment. What kind of heat bath surrounds the system is irrelevant, so long as it has a well-defined temperature, pressure, and chemical potential. This is not true, however, of the fluctuations around the average behavior, unless the bath is large compared to the system. In this exercise, we will explore the number fluctuations of a subvolume of a total system  $K$  times as large.

Let us calculate the probability of having  $n$  particles in a subvolume  $V$ , for a box with total volume  $KV$  and a total number of particles  $T = KN_0$ . For  $K = 2$  we will derive our previous result, eqn 3.11, including the prefactor. As  $K \rightarrow \infty$  we will derive the infinite volume result.

(a) Find the exact formula for this probability;  $n$  particles in  $V$ , with a total of  $T$  particles in  $KV$ . (Hint: What is the probability that the first  $n$  particles fall in the subvolume  $V$ , and the remainder  $T - n$  fall outside the subvolume  $(K - 1)V$ ? How many ways are there to pick  $n$  particles from  $T$  total particles?)

The Poisson probability distribution

$$\rho_n = a^n e^{-a} / n! \quad (3.66)$$

arises in many applications. It arises whenever there is a large number of possible events  $T$  each with a small probability  $a/T$ ; e.g., the number of cars passing a given point during an hour on a mostly empty street, the number of cosmic rays hitting in a given second, etc.

(b) Show that the Poisson distribution is normalized:  $\sum_n \rho_n = 1$ . Calculate the mean of the

distribution  $\langle n \rangle$  in terms of  $a$ . Calculate the variance (standard deviation squared)  $\langle (n - \langle n \rangle)^2 \rangle$ .

(c) As  $K \rightarrow \infty$ , show that the probability that  $n$  particles fall in the subvolume  $V$  has the Poisson distribution 3.66. What is  $a$ ? (Hint: You will need to use the fact that  $e^{-a} = (e^{-1/K})^{Ka} \rightarrow (1 - 1/K)^{Ka}$  as  $K \rightarrow \infty$ , and the fact that  $n \ll T$ . Here do not assume that  $n$  is large; the Poisson distribution is valid even if there are only a few events.)

From parts (b) and (c), you should be able to conclude that the variance in the number of particles found in a volume  $V$  inside an infinite system should be equal to  $N_0$ , the expected number of particles in the volume:

$$\langle (n - \langle n \rangle)^2 \rangle = N_0. \quad (3.67)$$

This is twice the squared fluctuations we found for the case where the volume  $V$  was half of the total volume, eqn 3.11. That makes sense, since the particles can fluctuate more freely in an infinite volume than in a doubled volume.

If  $N_0$  is large, will the probability  $P_m$  that  $N_0 + m$  particles lie inside our volume still be Gaussian? Let us check this for all  $K$ . First, as in Section 3.2.1, let us use the weak form of Stirling's approximation, eqn 3.8 dropping the square root:  $n! \sim (n/e)^n$ .

(d) Using your result from part (a), write the exact formula for  $\log(P_m)$ . Apply the weak form of Stirling's formula. Expand your result around  $m = 0$  to second order in  $m$ , and show that  $\log(P_m) \approx -m^2/2\sigma_K^2$ , giving a Gaussian form

$$P_m \sim e^{-m^2/2\sigma_K^2}. \quad (3.68)$$

What is  $\sigma_K$ ? In particular, what are  $\sigma_2$  and  $\sigma_\infty$ ? Your result for  $\sigma_2$  should agree with the calculation in Section 3.2.1, and your result for  $\sigma_\infty$  should agree with eqn 3.67.

Finally, we should address the normalization of the Gaussian. Notice that the ratio of the strong and weak forms of Stirling's formula (eqn 3.8) is  $\sqrt{2\pi n}$ . We need to use this to produce the normalization  $1/\sqrt{2\pi}\sigma_K$  of our Gaussian.

(e) In terms of  $T$  and  $n$ , what factor would the square root term have contributed if you had kept it in Stirling's formula going from part (a) to part (d)? (It should look like a ratio involving three terms like  $\sqrt{2\pi X}$ .) Show from eqn 3.68 that the fluctuations are small,  $m = n - N_0 \ll$

$N_0$  for large  $N_0$ . Ignoring these fluctuations, set  $n = N_0$  in your factor, and give the prefactor multiplying the Gaussian in eqn 3.68. (Hint: Your answer should be normalized.)

(3.10) **Triple product relation.** (Thermodynamics, Mathematics) ③

In traditional thermodynamics, one defines the pressure as minus the change in energy with volume  $P = -(\partial E/\partial V)|_{N,S}$ , and the chemical potential as the change in energy with number of particles  $\mu = (\partial E/\partial N)|_{V,S}$ . The total internal energy satisfies

$$dE = T dS - P dV + \mu dN. \quad (3.69)$$

(a) Show by solving eqn 3.69 for  $dS$  that  $(\partial S/\partial V)|_{N,E} = P/T$  and  $(\partial S/\partial N)|_{V,E} = -\mu/T$ .

I have always been uncomfortable with manipulating  $dX$ s.<sup>57</sup> How can we derive these relations with traditional partial derivatives? Our equation of state  $S(E, V, N)$  at fixed  $N$  is a surface embedded in three dimensions. Figure 3.4 shows a triangle on this surface, which we can use to derive a general triple-product relation between partial derivatives.

(b) Show, if  $f$  is a function of  $x$  and  $y$ , that  $(\partial x/\partial y)|_f(\partial y/\partial f)|_x(\partial f/\partial x)|_y = -1$ . (Hint: Consider the triangular path in Fig. 3.4. The first side starts at  $(x_0, y_0, f_0)$  and moves along a contour at constant  $f$  to  $y_0 + \Delta y$ . The resulting vertex will thus be at  $(x_0 + (\partial x/\partial y)|_f \Delta y, y_0 + \Delta y, f_0)$ . The second side runs at constant  $x$  back to  $y_0$ , and the third side runs at constant  $y$  back to  $(x_0, y_0, f_0)$ . The curve must close to make  $f$  a single-valued function; the resulting equation should imply the triple-product relation.)

(c) Starting from the ‘traditional’ definitions for  $P$  and  $\mu$ , apply your formula from part (b) to  $S$  at fixed  $E$  to derive the two equations in part (a) again. (This last calculation is done in the reverse direction in Section 3.4.)

(3.11) **Maxwell relations.** (Thermodynamics, Mathematics) ③

Consider the microcanonical formula for the equilibrium energy  $E(S, V, N)$  of some general system.<sup>58</sup> One knows that the second derivatives of  $E$  are symmetric; at fixed  $N$ , we get the same answer whichever order we take partial derivatives with respect to  $S$  and  $V$ .

(a) Use this to show the Maxwell relation

$$\left. \frac{\partial T}{\partial V} \right|_{S,N} = - \left. \frac{\partial P}{\partial S} \right|_{V,N}. \quad (3.70)$$

(This should take two lines of calculus or less.) Generate two other similar formulae by taking other second partial derivatives of  $E$ . There are many of these relations [52].

(b) Statistical mechanics check of the Maxwell relation. Using eqn 3.57, derive formulae for  $E(S, V, N)$ ,  $T(S, V, N) = (\partial E/\partial S)|_{V,N}$ , and  $P(S, V, N) = -(\partial E/\partial V)|_{S,N}$  for the ideal gas. (Make sure you have  $T$  and  $P$  as functions  $N$ ,  $V$ , and  $S$  and not  $E$ .) Show explicitly that the Maxwell relation eqn 3.70 is satisfied.

(3.12) **Solving differential equations: the pendulum.**<sup>59</sup> (Computation) ④

Physical systems usually evolve continuously in time; their laws of motion are differential equations. Computer simulations must approximate these differential equations using discrete time steps. In this exercise, we will introduce the most common and important method used for molecular dynamics simulations, together with fancier techniques used for solving more general differential equations.

We will use these methods to solve for the dynamics of a pendulum:

$$\frac{d^2\theta}{dt^2} = \ddot{\theta} = -\frac{g}{L} \sin(\theta). \quad (3.71)$$

This equation gives the motion of a pendulum with a point mass at the tip of a massless rod<sup>60</sup> of length  $L$ . You may wish to rederive it using a free-body diagram.

Go to our web site [129] and download the pendulum files for the language you will be using.

<sup>57</sup>They are really *differential forms*, which are mathematically subtle (see note 23 on p. 116).

<sup>58</sup>One can derive the formula by solving  $S = S(N, V, E)$  for  $E$ . It is the same surface in four dimensions as  $S(N, V, E)$  (Fig. 3.4) with a different direction pointing ‘up’.

<sup>59</sup>This exercise and the associated software were developed in collaboration with Christopher Myers. See also *Numerical Recipes* [106, chapter 16].

<sup>60</sup>We will depict our pendulum emphasizing the rod rather than the mass; the equation for a physical rod without an end mass is similar.

The animation should show a pendulum oscillating from an initial condition  $\theta_0 = 2\pi/3$ ,  $\dot{\theta} = 0$ ; the equations being solved have  $g = 9.8 \text{ m/s}^2$  and  $L = 1 \text{ m}$ .

There are three independent criteria for picking a good algorithm for solving differential equations: *fidelity*, *accuracy*, and *stability*.

*Fidelity.* In our time step algorithm, we do not make the straightforward choice—using the current  $(\theta(t), \dot{\theta}(t))$  to produce  $(\theta(t + \delta), \dot{\theta}(t + \delta))$ . Rather, we use a staggered algorithm:  $\theta(t)$  determines the acceleration and the update  $\dot{\theta}(t) \rightarrow \dot{\theta}(t + \delta)$ , and then  $\dot{\theta}(t + \delta)$  determines the update  $\theta(t) \rightarrow \theta(t + \delta)$ :

$$\dot{\theta}(t + \delta) = \dot{\theta}(t) + \ddot{\theta}(t) \delta, \quad (3.72)$$

$$\theta(t + \delta) = \theta(t) + \dot{\theta}(t + \delta) \delta. \quad (3.73)$$

Would it not be simpler and make more sense to update  $\theta$  and  $\dot{\theta}$  simultaneously from their current values, so that eqn 3.73 would read  $\theta(t + \delta) = \theta(t) + \dot{\theta}(t) \delta$ ? This simplest of all time-stepping schemes is called the *Euler method*, and should not be used for ordinary differential equations (although it is sometimes used for solving partial differential equations).

(a) Try the Euler method. First, see why reversing the order of the updates to  $\theta$  and  $\dot{\theta}$ ,

$$\begin{aligned} \theta(t + \delta) &= \theta(t) + \dot{\theta}(t) \delta, \\ \dot{\theta}(t + \delta) &= \dot{\theta}(t) + \ddot{\theta}(t) \delta, \end{aligned} \quad (3.74)$$

in the code you have downloaded would produce a simultaneous update. Swap these two lines in the code, and watch the pendulum swing for several turns, until it starts looping the loop. Is the new algorithm as good as the old one? (Make sure you switch the two lines back afterwards.)

The simultaneous update scheme is just as accurate as the one we chose, but it is not as faithful to the physics of the problem; its fidelity is not as good. For subtle reasons that we will not explain here, updating first  $\dot{\theta}$  and then  $\theta$  allows our algorithm to exactly simulate an approximate Hamiltonian system;<sup>61</sup> it is called a *symplectic* algorithm.<sup>62</sup> Improved versions of this

algorithm—like the Verlet algorithms below—are often used to simulate systems that conserve energy (like molecular dynamics) because they exactly<sup>63</sup> simulate the dynamics for an approximation to the Hamiltonian—preserving important physical features not kept by just approximately solving the dynamics.

*Accuracy.* Most computational methods for solving differential equations (and many other continuum problems like integrating functions) involve a step size  $\delta$ , and become more accurate as  $\delta$  gets smaller. What is most important is not the error in each time step, but the accuracy of the answer after a fixed time  $T$ , which is the accumulated error after  $T/\delta$  time steps. If this accumulated error varies as  $\delta^n$ , we say that the algorithm has  $n$ th order cumulative accuracy. Our algorithm is not very high order!

(b) Solve eqns 3.72 and 3.73 to give  $\theta(t + \delta)$  in terms of  $\theta(t)$ ,  $\dot{\theta}(t)$  and  $\ddot{\theta}(t)$  for our staggered algorithm. Comparing to the Taylor series  $x(t + \tau) = x(t) + v\tau + \frac{1}{2}a\tau^2 + O(\tau^3)$  applied to  $\theta(t)$ , what order in  $\delta$  is the error for  $\theta$  in a single time-step? Looking at eqn 3.73, what is the error in one time step for  $\dot{\theta}$ ? Given that the worst of the two accuracies should determine the overall accuracy, and that the time step error accumulates over more steps as the step size decreases, what order should the cumulative accuracy be for our staggered algorithm?

(c) Plot the pendulum trajectory  $\theta(t)$  for time steps  $\delta = 0.1, 0.01, \text{ and } 0.001$ . Zoom in on the curve at one of the coarse points (say,  $t = 1$ ) and visually compare the values from the three time steps. Does it appear that the trajectory is converging<sup>64</sup> as  $\delta \rightarrow 0$ ? What order cumulative accuracy do you find: is each curve better by a factor of 10, 100, 1000...?

A rearrangement of our staggered time-step (eqns 3.72 and 3.73) gives the *velocity Verlet* algorithm:

$$\begin{aligned} \dot{\theta}(t + \delta/2) &= \dot{\theta}(t) + \frac{1}{2}\ddot{\theta}(t) \delta, \\ \theta(t + \delta) &= \theta(t) + \dot{\theta}(t + \delta/2) \delta, \\ \dot{\theta}(t + \delta) &= \dot{\theta}(t + \delta/2) + \frac{1}{2}\ddot{\theta}(t + \delta)\delta. \end{aligned} \quad (3.75)$$

<sup>61</sup>Equation 3.73 is Hamiltonian dynamics for non-interacting particles, and  $m$  times eqn 3.72 is the momentum evolution law  $\dot{p} = F$  for a system of particles with infinite mass.

<sup>62</sup>It conserves a *symplectic form*. In non-mathematician's language, this means our time step perfectly simulates a Hamiltonian system satisfying Liouville's theorem and energy conservation, but with an approximation to the true energy.

<sup>63</sup>Up to rounding errors.

<sup>64</sup>You may note that the approximate answers seem to extrapolate nicely to the correct answer. One can use this to converge more quickly to the correct answer. This is called Richardson extrapolation and is the basis for the Bulirsch–Stoer methods.

The trick that makes this algorithm so good is to cleverly split the velocity increment into two pieces, half for the acceleration at the old position and half for the new position. (Initialize  $\dot{\theta}$  once before starting the loop.)

(d) Show that  $N$  steps of our staggered time-step would give the velocity Verlet algorithm, if we shifted the velocities before and afterward by  $\mp \frac{1}{2}\delta\ddot{\theta}$ .

(e) As in part (b), write  $\theta(t+\delta)$  for velocity Verlet in terms of quantities at  $t$ . What order cumulative accuracy does this suggest?

(f) Implement velocity Verlet, and plot the trajectory for time steps  $\delta = 0.1, 0.01, \text{ and } 0.001$ . What is the order of cumulative accuracy?

*Stability.* In many cases high accuracy is not crucial. What prevents us from taking enormous time steps? In a given problem, there is usually a typical fastest time scale: a vibration or oscillation period (as in our exercise) or a growth or decay rate. When our time step becomes a substantial fraction of this fastest time scale, algorithms like ours usually become *unstable*; the first few time steps may be fairly accurate, but small errors build up exponentially until the errors become unacceptable (indeed, often one's first warning of problems are machine overflows). (g) Plot the pendulum trajectory  $\theta(t)$  for time steps  $\delta = 0.1, 0.2, \dots, 0.8$ , using a small-amplitude oscillation  $\theta_0 = 0.01$ ,  $\dot{\theta}_0 = 0.0$ , up to  $t_{\max} = 10$ . At about what  $\delta_c$  does it go unstable? How does  $\delta_c$  compare with the characteristic time period of the pendulum? At  $\delta_c/2$ , how accurate is the amplitude of the oscillation? (You will need to observe several periods in order to estimate the maximum amplitude of the solution.)

In solving the properties of large, nonlinear systems (e.g., partial differential equations (PDEs) and molecular dynamics) stability tends to be the key difficulty. The maximum step-size depends on the local configuration, so highly nonlinear regions can send the system unstable before one might expect. The maximum safe stable step-size often has accuracy far higher than needed.

The Verlet algorithms are not hard to code. There are higher-order symplectic algorithms for Hamiltonian systems, but they are mostly used in unusual applications (planetary motion) where high accuracy is demanded, because they are typically significantly less stable. In systems of differential equations where there is

no conserved energy or Hamiltonian, or even in Hamiltonian systems (like high-energy collisions) where accuracy at short times is more crucial than fidelity at long times, we use general-purpose methods.

*ODE (Ordinary Differential Equation) packages.* The general-purpose solvers come in a variety of basic algorithms (Runge-Kutta, predictor-corrector, ...), and methods for maintaining and enhancing accuracy (variable step size, Richardson extrapolation). There are also *implicit* methods for *stiff* systems. A system is stiff if there is a large separation between the slowest and fastest relevant time scales; implicit methods often allow one to take time steps much larger than the fastest time scale (unlike the explicit Verlet methods you studied in part (d), which go unstable). Large, sophisticated packages have been developed over many years for solving differential equations—switching between algorithms and varying the time steps to most efficiently maintain a given level of accuracy. They solve  $\mathbf{dy}/dt = \mathbf{dydt}(\mathbf{y}, t)$ , where for us  $\mathbf{y} = [\theta, \dot{\theta}]$  and  $\mathbf{dydt} = [\ddot{\theta}, \dot{\theta}]$ . They typically come in the form of subroutines or functions, which need the following as arguments:

- initial conditions  $\mathbf{y}_0$ ,
- the right-hand side  $\mathbf{dydt}$ , a function of the vector  $\mathbf{y}$  and time  $t$ , which returns a vector giving the current rate of change of  $\mathbf{y}$ , and
- the initial and final times, and perhaps intermediate times, at which the trajectory  $\mathbf{y}(t)$  is desired.

They often have options that

- ask for desired accuracy goals, typically a relative (fractional) accuracy and an absolute accuracy, sometimes set separately for each component of  $\mathbf{y}$ ,
- ask for and return derivative and time step information from the end of the last step (to allow efficient restarts after intermediate points),
- ask for a routine that computes the derivatives of  $\mathbf{dydt}$  with respect to the current components of  $\mathbf{y}$  (for use by the stiff integrator), and
- return information about the methods, time steps, and performance of the algorithm.

You will be supplied with one of these general-purpose packages, and instructions on how to use it.



(h) Write the function **dydt**, and use the general-purpose solver to solve for the motion of the pendulum as in parts (a)–(c), and informally

check that the trajectory is accurate.



# Phase-space dynamics and ergodicity



So far, our justification for using the microcanonical ensemble was simple ignorance; all we know about the complex motion is that energy must be conserved, so we average over all states in phase space of fixed energy.<sup>1</sup> Here we provide a much more convincing argument for the ensemble, and hence for equilibrium statistical mechanics as a whole. In Section 4.1 we will show for classical systems that averaging over the energy surface<sup>2</sup> is consistent with time evolution. Liouville's theorem will tell us that volume in phase space is conserved, so the trajectories only stir the energy surface around, they do not change the relative weights of different parts of the surface. In Section 4.2 we introduce the concept of *ergodicity*; an ergodic system has an energy surface which is well stirred. Using Liouville's theorem and assuming ergodicity will allow us to show<sup>3</sup> that the microcanonical ensemble average gives the long-time average behavior that we call equilibrium.

## 4.1 Liouville's theorem

In Chapter 3, we saw that treating all states in phase space with a given energy on an equal footing gave sensible predictions for the ideal gas, but we did not show that this democratic treatment was necessarily the correct one. Liouville's theorem, true for all Hamiltonian systems, will tell us that all states are created equal.

Systems of point particles obeying Newton's laws without dissipation are examples of Hamiltonian dynamical systems. These systems conserve the energy, given by the Hamiltonian  $\mathcal{H}(\mathbb{P}, \mathbb{Q})$ . The laws of motion are given from  $\mathcal{H}$  by *Hamilton's equations*:

$$\begin{aligned}\dot{q}_\alpha &= \partial\mathcal{H}/\partial p_\alpha, \\ \dot{p}_\alpha &= -\partial\mathcal{H}/\partial q_\alpha,\end{aligned}\tag{4.1}$$

where as usual  $\dot{X} = \partial X/\partial t$ . The standard example of a Hamiltonian, and the only example we will discuss in this text, is a bunch of particles interacting with a potential energy  $U$ :

$$\mathcal{H}(\mathbb{P}, \mathbb{Q}) = \sum_\alpha p_\alpha^2/2m_\alpha + U(q_1, \dots, q_{3N}).\tag{4.2}$$

In this case, one immediately finds the expected Newtonian equations

4.1 Liouville's theorem	63
4.2 Ergodicity	65

<sup>1</sup>If you are willing to take this energy-surface average on trust, the rest of this text does not depend on the results in this chapter.

<sup>2</sup>The energy surface should be thought of as the energy shell  $E < \mathcal{H}(\mathbb{P}, \mathbb{Q}) < E + \delta E$  in the limit  $\delta E \rightarrow 0$ . We focus here on the energy surface rather than the energy shell because the different energies in the shell do not get intermingled by the time evolution.

<sup>3</sup>We do not aspire to mathematical rigor, but we will provide physical arguments for rigorously known results; see [79].

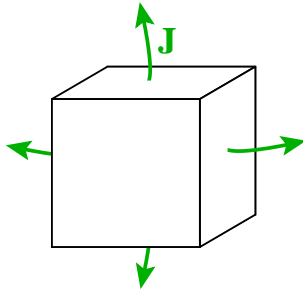
of motion:

$$\begin{aligned} \dot{q}_\alpha &= \partial\mathcal{H}/\partial p_\alpha = p_\alpha/m_\alpha, \\ \dot{p}_\alpha &= -\partial\mathcal{H}/\partial q_\alpha = -\partial U/\partial q_\alpha = f_\alpha(q_1, \dots, q_{3N}), \end{aligned} \tag{4.3}$$

<sup>4</sup>You will cover Hamiltonian dynamics in detail in most advanced courses in classical mechanics. For those who do not already know about Hamiltonians, rest assured that we will not use anything other than the special case of Newton’s laws for point particles; you can safely ignore the more general case for our purposes.

<sup>5</sup>In Section 7.1 we discuss the quantum version of Liouville’s theorem.

<sup>6</sup>For the mathematically sophisticated reader, Hamiltonian dynamics preserves a *symplectic form*  $\omega = dq_1 \wedge dp_1 + \dots + dq_{3N} \wedge dp_{3N}$ ; Liouville’s theorem follows because the volume in phase space is  $\omega^{3N}$ .



**Fig. 4.1 Conserved currents in 3D.** Think of the flow in and out of a small volume  $\Delta V$  in space. The change in the density inside the volume  $\partial\rho_{3D}/\partial t \Delta V$  must equal minus the flow of material out through the surface  $-\int \mathbf{J} \cdot d\mathbf{S}$ , which by Gauss’ theorem equals  $-\int \nabla \cdot \mathbf{J} dV \sim -\nabla \cdot \mathbf{J} \Delta V$ .

<sup>7</sup>In contrast, it *would* typically generally depend on the coordinate  $q_\alpha$ .

where  $f_\alpha$  is the force on coordinate  $\alpha$ . More general Hamiltonians<sup>4</sup> arise when studying, for example, the motions of rigid bodies or mechanical objects connected by hinges and joints, where the natural variables are angles or relative positions rather than points in space. Hamiltonians also play a central role in quantum mechanics.<sup>5</sup>

Hamiltonian systems have properties that are quite distinct from general systems of differential equations. They not only conserve energy, they also have many other unusual properties.<sup>6</sup> Liouville’s theorem describes the most important of these properties.

Consider the evolution law for a general probability density in phase space:

$$\rho(\mathbb{P}, \mathbb{Q}) = \rho(q_1, \dots, q_{3N}, p_1, \dots, p_{3N}). \tag{4.4}$$

(As a special case, the microcanonical ensemble has  $\rho$  equal to a constant in a thin range of energies, and zero outside that range.) This probability density  $\rho$  is *locally conserved*: probability cannot be created or destroyed, it can only flow around in phase space. As an analogy, suppose a fluid of mass density  $\rho_{3D}(x)$  in three dimensions has a velocity  $v(x)$ . Because mass density is locally conserved,  $\rho_{3D}$  must satisfy the continuity equation  $\partial\rho_{3D}/\partial t = -\nabla \cdot \mathbf{J}$ , where  $\mathbf{J} = \rho_{3D}\mathbf{v}$  is the mass current (Fig. 4.1). In the same way, the probability density in  $6N$  dimensions has a phase-space probability current  $(\rho\dot{\mathbb{P}}, \rho\dot{\mathbb{Q}})$  and hence satisfies a continuity equation

$$\begin{aligned} \frac{\partial\rho}{\partial t} &= -\nabla_{6N}(\rho\mathbf{v}_{6N}) = -\sum_{\alpha=1}^{3N} \left( \frac{\partial(\rho\dot{q}_\alpha)}{\partial q_\alpha} + \frac{\partial(\rho\dot{p}_\alpha)}{\partial p_\alpha} \right) \\ &= -\sum_{\alpha=1}^{3N} \left( \frac{\partial\rho}{\partial q_\alpha} \dot{q}_\alpha + \rho \frac{\partial\dot{q}_\alpha}{\partial q_\alpha} + \frac{\partial\rho}{\partial p_\alpha} \dot{p}_\alpha + \rho \frac{\partial\dot{p}_\alpha}{\partial p_\alpha} \right). \end{aligned} \tag{4.5}$$

Now, it is clear what is meant by  $\partial\rho/\partial q_\alpha$ , since  $\rho$  is a function of the  $q_\alpha$ s and  $p_\alpha$ s. But what is meant by  $\partial\dot{q}_\alpha/\partial q_\alpha$ ? For our example of point particles,  $\dot{q}_\alpha = p_\alpha/m$  has no dependence on  $q_\alpha$ ; nor does  $\dot{p}_\alpha = f_\alpha(q_1, \dots, q_{3N})$  have any dependence on the momentum  $p_\alpha$ .<sup>7</sup> Hence these two mysterious terms in eqn 4.5 both vanish for Newton’s laws for point particles. Indeed, using Hamilton’s equations 4.1, we find that they cancel one another for a general Hamiltonian system:

$$\begin{aligned} \partial\dot{q}_\alpha/\partial q_\alpha &= \partial(\partial\mathcal{H}/\partial p_\alpha)/\partial q_\alpha = \partial^2\mathcal{H}/\partial p_\alpha\partial q_\alpha = \partial^2\mathcal{H}/\partial q_\alpha\partial p_\alpha \\ &= \partial(\partial\mathcal{H}/\partial q_\alpha)/\partial p_\alpha = \partial(-\dot{p}_\alpha)/\partial p_\alpha = -\partial\dot{p}_\alpha/\partial p_\alpha. \end{aligned} \tag{4.6}$$

This leaves us with the equation

$$\frac{\partial\rho}{\partial t} + \sum_{\alpha=1}^{3N} \frac{\partial\rho}{\partial q_\alpha} \dot{q}_\alpha + \frac{\partial\rho}{\partial p_\alpha} \dot{p}_\alpha = \frac{d\rho}{dt} = 0. \tag{4.7}$$

This is Liouville's theorem.

What is  $d\rho/dt$ , and how is it different from  $\partial\rho/\partial t$ ? The former is called the *total derivative* of  $\rho$  with respect to time; it is the evolution of  $\rho$  seen by a particle moving with the flow. In a three-dimensional flow,  $d\rho_{3D}/dt = \partial\rho/\partial t + \mathbf{v} \cdot \nabla\rho = \partial\rho/\partial t + \sum_{i=1}^3 \dot{x}_i(\partial\rho/\partial x_i)$ ; the first term is the change in  $\rho$  due to the time evolution at fixed position, and the second is the change in  $\rho$  that a particle moving with velocity  $\mathbf{v}$  would see if the  $\rho$  field did not change in time. Equation 4.7 is the same physical situation, but in  $6N$ -dimensional phase space.

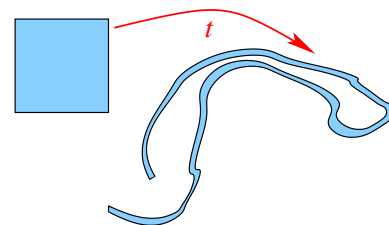
What does Liouville's theorem,  $d\rho/dt = 0$ , tell us about Hamiltonian dynamics?

- **Flows in phase space are incompressible.** In fluid mechanics, if the density  $d\rho_{3D}/dt = 0$  it means that the fluid is incompressible. The density of a small element of fluid does not change as it moves around in the fluid; hence the small element is not compressing or expanding. In Liouville's theorem, it means the same thing; a small volume in phase space will evolve into a new shape, perhaps stretched, twisted, or folded, but with exactly the same volume (Fig. 4.2).
- **There are no attractors.** In other dynamical systems, most states of the system are usually transient, and the system settles down onto a small set of states called the *attractor*. A damped pendulum will stop moving; the attractor has zero velocity and vertical angle (Exercise 4.2). A forced, damped pendulum will settle down to oscillate with a particular amplitude; the attractor is a circle in phase space. The decay of these transients in dissipative systems would seem closely related to equilibration in statistical mechanics, where at long times all initial states of a system will settle down into static equilibrium behavior.<sup>8</sup> Perversely, we have just proven that equilibration in statistical mechanics happens by a completely different mechanism! In equilibrium statistical mechanics all states are created equal; transient states are temporary only insofar as they are very unusual, so as time evolves they disappear, to arise again only as rare fluctuations.
- **Microcanonical ensembles are time independent.** An initial uniform density in phase space will stay uniform. More generally, since energy is conserved, a uniform density over a small shell of energies  $(E, E + \delta E)$  will stay uniform.

Liouville's theorem tells us that the energy surface may get stirred around, but the relative weights of parts of the surface are given by their phase-space volumes (Fig. 3.1) and do not change. This property is a necessary condition for our microcanonical ensemble to describe the time-independent equilibrium state.

## 4.2 Ergodicity

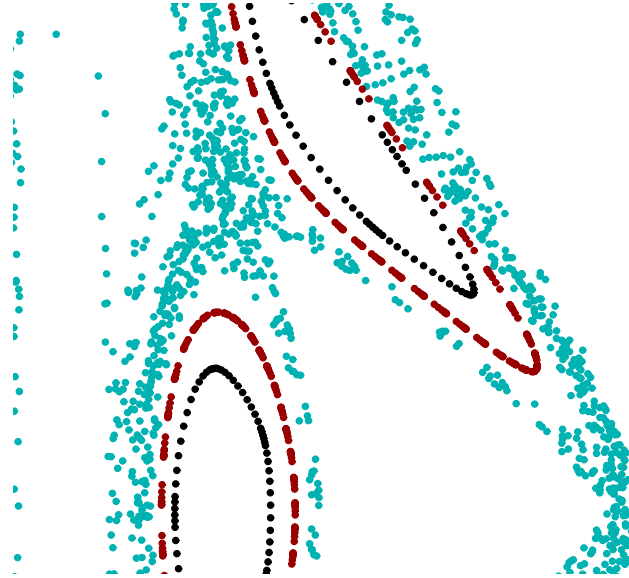
By averaging over the energy surface, statistical mechanics is making a hypothesis, first stated by Boltzmann. Roughly speaking, the hypothesis



**Fig. 4.2 Incompressible flow.** A small volume in phase space may be stretched and twisted by the flow, but Liouville's theorem shows that the volume stays unchanged.

<sup>8</sup>We will return to the question of how irreversibility and damping emerge from statistical mechanics many times in the rest of this book. It will always involve introducing approximations to the microscopic theory.

**Fig. 4.3 KAM tori and non-ergodic motion.** This is a (Poincaré) cross-section (Fig. 4.8) of Earth's motion in the three-body problem (Exercise 4.4), with Jupiter's mass set at almost 70 times its actual value. The closed loops correspond to trajectories that form tori in phase space, whose cross-sections look like deformed circles in our view. The complex filled region is a single trajectory exhibiting chaotic motion, and represents an ergodic component. The tori, each an ergodic component, can together be shown to occupy non-zero volume in phase space, for small Jovian masses. Note that this system is not ergodic according to either of our definitions. The trajectories on the tori never explore the rest of the energy surface. The region  $R$  formed by the chaotic domain is invariant under the time evolution; it has positive volume and the region outside  $R$  also has positive volume.



<sup>9</sup>Mathematicians distinguish between ergodic (stirred) and *mixing* (scrambled); we only need to assume ergodicity here. See [79] for more information about ergodicity.

<sup>10</sup>What does *almost every* mean? Technically, it means all but a set of zero volume (measure zero). Basically, the qualification 'almost' is there to avoid problems with unusual, specific initial conditions like all the particles moving precisely at the same velocity in neat rows.

<sup>11</sup>Why not just assume that every point on the energy surface gets passed through? Boltzmann originally did assume this. However, it can be shown that a smooth curve (our time-trajectory) cannot fill up a whole volume (the energy surface). In an ergodic system the trajectory covers the energy surface densely, but not completely.

<sup>12</sup>If an ergodic system equilibrates (i.e., does not oscillate forever), the time average behavior will be determined by the equilibrium behavior; ergodicity then implies that the equilibrium properties are equal to the microcanonical averages.

<sup>13</sup>Here  $S$  is the energy surface.

is that the energy surface is thoroughly stirred by the time evolution; it is not divided into some kind of components that do not intermingle (see Fig. 4.3). A system which is thoroughly stirred is said to be *ergodic*.<sup>9</sup> The original way of defining ergodicity is due to Boltzmann. Adapting his definition, we have

*Definition 1* In an *ergodic* system, the trajectory of almost every<sup>10</sup> point in phase space eventually passes arbitrarily close<sup>11</sup> to every other point (position and momentum) on the surface of constant energy.

The most important consequence of ergodicity is that *time averages are equal to microcanonical averages*.<sup>12</sup> Intuitively, since the trajectory  $(\mathbb{P}(t), \mathbb{Q}(t))$  covers the whole energy surface, the average of any property  $O(\mathbb{P}(t), \mathbb{Q}(t))$  over time is the same as the average of  $O$  over the energy surface.

This turns out to be tricky to prove, though. It is easier mathematically to work with another, equivalent definition of ergodicity. This definition roughly says that the energy surface cannot be divided into components which do not intermingle. Let us define an *ergodic component*  $R$  of a set<sup>13</sup>  $S$  to be a subset that remains invariant under the flow (so  $r(t) \in R$  for all  $r(0) \in R$ ).

*Definition 2* A time evolution in a set  $S$  is *ergodic* if and only if all the ergodic components  $R$  in  $S$  either have zero volume or have a volume equal to the volume of  $S$ .

We can give an intuitive explanation of why these two definitions are equivalent (but it is hard to prove). A trajectory  $r(t)$  must lie within a single ergodic component. If  $r(t)$  covers the energy surface

densely (Definition 1), then there is ‘no more room’ for a second ergodic component with non-zero volume (Definition 2).<sup>14</sup> Conversely, if there is only one ergodic component  $R$  with volume equal to  $S$  (Definition 2), then any trajectory starting in  $R$  must get arbitrarily close to all points in  $R$  (Definition 1), otherwise the points in  $R$  ‘far’ from the trajectory (outside the closure of the trajectory) would be an invariant set of non-zero volume.

Using this second definition of ergodic, we can argue that time averages must equal microcanonical averages. Let us denote the microcanonical average of an observable  $O$  as  $\langle O \rangle_S$ , and let us denote the time average starting at initial condition  $(\mathbb{P}, \mathbb{Q})$  as  $\overline{O(\mathbb{P}(0), \mathbb{Q}(0))} = \lim_{T \rightarrow \infty} (1/T) \int_0^T O(\mathbb{P}(t), \mathbb{Q}(t)) dt$ .

Showing that the time average  $\bar{O}$  equals the ensemble average  $\langle O \rangle_S$  for an ergodic system (using this second definition) has three steps.

- (1) **Time averages are constant on trajectories.** If  $O$  is a nice function (e.g. without any infinities on the energy surface), then

$$\overline{O(\mathbb{P}(0), \mathbb{Q}(0))} = \overline{O(\mathbb{P}(t), \mathbb{Q}(t))}; \tag{4.8}$$

the future time average does not depend on the values of  $O$  during the finite time interval  $(0, t)$ . Thus the time average  $\bar{O}$  is constant along the trajectory.<sup>15</sup>

- (2) **Time averages are constant on the energy surface.** Now consider the subset  $R_a$  of the energy surface where  $\bar{O} < a$ , for some value  $a$ . Since  $\bar{O}$  is constant along a trajectory, any point in  $R_a$  is sent under the time evolution to another point in  $R_a$ , so  $R_a$  is an ergodic component. If we have ergodic dynamics on the energy surface, that means the set  $R_a$  has either zero volume or the volume of the energy surface. This implies that  $\bar{O}$  is a constant on the energy surface (except on a set of zero volume); its value is  $a^*$ , the lowest value where  $R_{a^*}$  has the whole volume. Thus the equilibrium, time average value of our observable  $O$  is independent of initial condition.

- (3) **Time averages equal microcanonical averages.** Is this equilibrium value given by the microcanonical ensemble average over  $S$ ? We need to show that the trajectories do not linger in some regions of the energy surface more than they should (based on the thickness of the energy shell, Fig. 3.1). Liouville’s theorem in Section 4.1 told us that the microcanonical ensemble was time independent, so the ensemble average equals its time average, which equals the ensemble average of the time average. But the time average is constant (except on a set of zero volume), so in an ergodic system the ensemble average equals the time average everywhere (except on a set of zero volume).<sup>16</sup>

Can we show that our systems are ergodic? Usually not.<sup>17</sup> Ergodicity has been proven for the collisions of hard spheres, and for geodesic motion on finite surfaces with constant negative curvature,<sup>18</sup> but not for many systems of immediate practical importance. Indeed, several fundamental problems precisely involve systems which are not ergodic.

<sup>14</sup>Mathematicians must be careful in the definitions and proofs to exclude different invariant sets that are infinitely finely intertwined.

<sup>15</sup>If we could show that  $\bar{O}$  had to be a continuous function, we would now be able to use the first definition of ergodicity to show that it was constant on the energy surface, since our trajectory comes close to every point on the surface. But it is not obvious that  $\bar{O}$  is continuous; for example, it is not continuous for Hamiltonian systems that are not ergodic. We can see this from Fig. 4.3; consider two initial conditions at nearby points, one just inside a chaotic region and the other on a KAM torus. The infinite time averages on these two trajectories for most quantities will be quite different;  $\bar{O}$  will typically have a jump at the boundary.

<sup>16</sup>In formulæ,  $\langle O \rangle_S = \langle O(t) \rangle_S = \langle O(\mathbb{P}(t), \mathbb{Q}(t)) \rangle_S$ , where the average  $\langle \cdot \rangle_S$  integrates over initial conditions  $(\mathbb{P}(0), \mathbb{Q}(0))$  but evaluates  $O$  at  $(\mathbb{P}(t), \mathbb{Q}(t))$ . Averaging over all time, and using the fact that the time average  $\bar{O} = a^*$  (almost everywhere), tells us

$$\begin{aligned} \langle O \rangle_S &= \lim_{T \rightarrow \infty} \frac{1}{T} \int_0^T \langle O(\mathbb{P}(t), \mathbb{Q}(t)) \rangle_S dt \\ &= \left\langle \lim_{T \rightarrow \infty} \frac{1}{T} \int_0^T O(\mathbb{P}(t), \mathbb{Q}(t)) dt \right\rangle_S \\ &= \langle \bar{O}(\mathbb{P}, \mathbb{Q}) \rangle_S = \langle a^* \rangle_S = a^*. \end{aligned} \tag{4.9}$$

<sup>17</sup>That is, it cannot be proven for the microscopic dynamics: it is often straightforward to show ergodicity for computer equilibration algorithms (see 8.2).

<sup>18</sup>Geodesic motion on a sphere would be motion at a constant speed around great circles. Geodesics are the shortest paths between two points. In general relativity, falling bodies travel on geodesics in space–time.

<sup>19</sup>Newton solved the gravitational two-body problem, giving Kepler's ellipse.

<sup>20</sup>That is, the twentieth century.

- **KAM tori and the three-body problem.** Generations of mathematicians and physicists have worked on the gravitational three-body problem.<sup>19</sup> The key challenge was showing that the interactions between the planets do not completely mess up their orbits over long times. One must note that ‘messing up their orbits’ is precisely what an ergodic system must do! (There is just as much phase space at constant energy with Earth and Venus exchanging places, and a whole lot more with Earth flying out into interstellar space.) In the last century<sup>20</sup> the KAM theorem was proven, which showed that (for small interplanetary interactions and a large fraction of initial conditions) the orbits of the planets qualitatively stayed in weakly-perturbed ellipses around the Sun (KAM tori, see Fig. 4.3). Other initial conditions, intricately intermingled with the stable ones, lead to chaotic motion. Exercise 4.4 investigates the KAM tori and chaotic motion in a numerical simulation.

From the KAM theorem and the study of chaos in these systems we learn that Hamiltonian systems with small numbers of particles are often, even usually, not ergodic—there are commonly regions formed by tori of non-zero volume which do not mix with the rest of the energy surface.

- **Fermi, Pasta, Ulam, and KdV.** You might think that this is a peculiarity of having only a few particles. Surely if there are lots of particles, such funny behavior has to go away? On one of the early computers developed for the Manhattan project, Fermi, Pasta, and Ulam tested this [38]. They took a one-dimensional chain of atoms, coupled them with anharmonic potentials, and tried to look for thermalization. To quote them [38, p. 978] :

Let us say here that the results of our computations were, from the beginning, surprising us. Instead of a continuous flow of energy from the first mode to the higher modes, all of the problems show an entirely different behavior. [...] Instead of a gradual increase of all the higher modes, the energy is exchanged, essentially, among only a certain few. It is, therefore, very hard to observe the rate of ‘thermalization’ or mixing in our problem, and this was the initial purpose of the calculation.

It turns out that their system, in the continuum limit, gave a partial differential equation (the Korteweg–de Vries equation) that was even weirder than planetary motion; it had an *infinite family* of conserved quantities, and could be exactly solved using a combination of fronts called *solitons*.

The kind of non-ergodicity found in the Korteweg–de Vries equation was thought to arise in only rather special one-dimensional systems. The discovery of anharmonic localized modes in generic, three-dimensional systems [110, 115, 133] suggests that non-ergodicity may arise in rather realistic lattice models.

- **Broken symmetry phases.** Many phases have *broken symmetries*.



Magnets, crystals, superfluids, and liquid crystals, for example, violate ergodicity because they only explore one of a variety of equal-energy ground states (see Chapter 9). For example, a liquid may explore all of phase space with a given energy, but an infinite crystal (with a neat grid of atoms aligned in a particular orientation) will never fluctuate to change its orientation, or (in three dimensions) the registry of its grid. That is, a 3D crystal has broken *orientational* and *translational* symmetries. The real system will explore only one ergodic component of the phase space (one crystal position and orientation), and we must do the same when making theories of the system.

- **Glasses.** There are other kinds of breakdowns of the ergodic hypothesis. For example, glasses fall out of equilibrium as they are cooled; they no longer ergodically explore all configurations, but just oscillate about one of many metastable glassy states. Certain models of glasses and disordered systems can be shown to break ergodicity—not just into a small family of macroscopic states as in normal symmetry-breaking phase transitions, but into an infinite number of different, disordered ground states. It is an open question whether real glasses truly break ergodicity when cooled infinitely slowly, or whether they are just sluggish, ‘frozen liquids’.

Should we be concerned that we cannot prove that our systems are ergodic? It is entertaining to point out the gaps in the foundations of statistical mechanics, especially since they tie into so many central problems in mathematics and physics (above). We emphasize that these gaps are for most purposes purely of academic concern. Statistical mechanics works phenomenally well in most systems with large numbers of interacting degrees of freedom.

Indeed, the level of rigor here is unusual. In other applications of statistical mechanics we rarely have as thorough a justification of our ensemble as Liouville and assuming ergodicity provides for equilibrium thermal systems.

---

## Exercises

*Equilibration* checks that realistic molecular dynamics simulations actually do settle down to states predicted by our equilibrium theories.

*Liouville vs. the damped pendulum* and *Invariant measures* explore analogues of Liouville’s theorem in dissipative and chaotic systems. The first investigates how the theorem breaks down when dissipation is added. The second explores the complex, singular ensemble formed by

the folding and stretching of a chaotic map.

*Jupiter! and the KAM theorem* vividly illustrates the breakdown of ergodicity in planetary motion; an ergodic solar system would be an unpleasant place to live.

(4.1) **Equilibration.**<sup>21</sup> (Computation) ②

Can we verify that realistic systems of atoms equilibrate? As we have discussed in Section 4.2, we do not know how to prove that systems of realistic

<sup>21</sup>This exercise and the associated software were developed in collaboration with Christopher Myers.

atoms are ergodic. Also, phase space is so large we cannot verify ergodicity by checking computationally that a trajectory visits all portions of it.

(a) For 20 particles in a box of size  $L \times L \times L$ , could we hope to test if our trajectory came close to all spatial configurations of the atoms? Let us call two spatial configurations ‘nearby’ if the corresponding atoms in the two configurations are in the same  $(L/10) \times (L/10) \times (L/10)$  subvolume. How many ‘distant’ spatial configurations are there? On a hypothetical computer that could test  $10^{12}$  such configurations per second, how many years would it take to sample this number of configurations? (Hint: Conveniently, there are roughly  $\pi \times 10^7$  seconds in a year.)

We certainly can solve Newton’s laws using molecular dynamics to check the equilibrium predictions made possible by assuming ergodicity. You may download our molecular dynamics software [10] and hints for this exercise from the text web site [129].

Run a constant-energy (microcanonical) simulation of a fairly dilute gas of Lennard–Jones particles (crudely modeling argon or other noble gases). Start the atoms at rest (an atypical, non-equilibrium state), but in a random configuration (except ensure that no two atoms in the initial configuration overlap, less than  $|\Delta \mathbf{r}| = 1$  apart). The atoms that start close to one another should start moving rapidly, eventually colliding with the more distant atoms until the gas equilibrates into a statistically stable state.

We have derived the distribution of the components of the momenta ( $p_x, p_y, p_z$ ) for an equilibrium ideal gas (eqn 3.19 of Section 3.2.2),

$$\rho(p_x) = \frac{1}{\sqrt{2\pi mk_B T}} \exp\left(-\frac{p_x^2}{2mk_B T}\right) \quad (4.10)$$

This momentum distribution also describes interacting systems such as the one we study here (as we shall show in Chapter 6).

(b) Plot a histogram of the components of the momentum in your gas for a few time intervals, multiplying the averaging time by four for each new graph, starting with just the first time-step. At short times, this histogram should be peaked around zero, since the atoms start at rest. Do they appear to equilibrate to the Gaussian prediction of eqn 4.10 at long times? Roughly estimate

the equilibration time, measured using the time dependence of the velocity distribution. Estimate the final temperature from your histogram.

These particles, deterministically following Newton’s laws, spontaneously evolve to satisfy the predictions of equilibrium statistical mechanics. This equilibration, peculiar and profound from a dynamical systems point of view, seems obvious and ordinary from the perspective of statistical mechanics. See Fig. 4.3 and Exercise 4.4 for a system of interacting particles (planets) which indeed does not equilibrate.

(4.2) **Liouville vs. the damped pendulum.** (Mathematics) ②

The damped pendulum has a force  $-\gamma p$  proportional to the momentum slowing down the pendulum. It satisfies the equations

$$\begin{aligned} \dot{x} &= p/M, \\ \dot{p} &= -\gamma p - K \sin(x). \end{aligned} \quad (4.11)$$

At long times, the pendulum will tend to an equilibrium stationary state, zero velocity at  $x = 0$  (or more generally at the equivalent positions  $x = 2m\pi$ , for  $m$  an integer);  $(p, x) = (0, 0)$  is an attractor for the damped pendulum. An ensemble of damped pendulums is started with initial conditions distributed with probability  $\rho(p_0, x_0)$ . At late times, these initial conditions are gathered together near the equilibrium stationary state; Liouville’s theorem clearly is not satisfied.

(a) In the steps leading from eqn 4.5 to eqn 4.7, why does Liouville’s theorem not apply to the damped pendulum? More specifically, what are  $\partial \dot{p} / \partial p$  and  $\partial \dot{q} / \partial q$ ?

(b) Find an expression for the total derivative  $d\rho/dt$  in terms of  $\rho$  for the damped pendulum. If we evolve a region of phase space of initial volume  $A = \Delta p \Delta x$  how will its volume depend upon time?

(4.3) **Invariant measures.**<sup>22</sup> (Mathematics, Complexity) ④

Liouville’s theorem tells us that all available points in phase space are equally weighted when a Hamiltonian system is averaged over all times. What happens for systems that evolve according to laws that are not Hamiltonian? Usually, the system does not continue to explore all points in its state space; at long times it is confined to a

<sup>22</sup>This exercise and the associated software were developed in collaboration with Christopher Myers; see [64]. Hints available [129].

subset of the original space known as the *attractor*.

We consider the behavior of the ‘logistic’ mapping from the unit interval  $(0, 1)$  into itself:<sup>23</sup>

$$f(x) = 4\mu x(1 - x). \quad (4.12)$$

We talk of the trajectory of an initial point  $x_0$  as the sequence of points  $x_0, f(x_0), f(f(x_0)), \dots, f^{[n]}(x_0), \dots$ . Iteration can be thought of as a time step (one iteration of a Poincaré return map of Exercise 4.4 or one step  $\Delta t$  in a time-step algorithm as in Exercise 3.12).

*Attracting fixed point.* For small  $\mu$ , our mapping has an attracting fixed-point. A fixed-point of a mapping is a value  $x^* = f(x^*)$ ; a fixed-point is stable if small perturbations shrink after iterating:

$$|f(x^* + \epsilon) - x^*| \approx |f'(x^*)|\epsilon < \epsilon, \quad (4.13)$$

which happens if the derivative  $|f'(x^*)| < 1$ .<sup>24</sup>

(a) Iteration. Set  $\mu = 0.2$ ; iterate  $f$  for some initial points  $0 < x_0 < 1$  of your choosing, and convince yourself that they are all attracted to zero. Plot  $f$  and the diagonal  $y = x$  on the same plot. Are there any fixed-points other than  $x = 0$ ? Repeat for  $\mu = 0.4$ , and 0.6. What happens?

*Analytics.* Find the non-zero fixed-point  $x^*(\mu)$  of the map 4.12, and show that it exists and is stable for  $1/4 < \mu < 3/4$ . If you are ambitious or have a computer algebra program, show that there is a stable, period-two cycle for  $3/4 < \mu < (1 + \sqrt{6})/4$ .

An attracting fixed-point is the antithesis of Liouville’s theorem; all initial conditions are transient except one, and all systems lead eventually to the same, time-independent state. (On the other hand, this is precisely the behavior we expect in statistical mechanics *on the macroscopic scale*; the system settles down into a time-independent equilibrium state! All microstates are equivalent, but the vast majority of accessible microstates have the same macroscopic behavior in most large systems.) We could define a rather trivial ‘equilibrium ensemble’ for this system, which consists

of the single point  $x^*$ ; any property  $O(x)$  will have the long-time average  $\langle O \rangle = O(x^*)$ .

For larger values of  $\mu$ , more complicated things happen. At  $\mu = 1$ , the dynamics can be shown to fill the entire interval; the dynamics is ergodic, and the attractor fills the entire set of available states. However, unlike the case of Hamiltonian systems, not all states are weighted equally (i.e., Liouville’s theorem does not hold).

We can find time averages for functions of  $x$  in two ways: by averaging over time (many iterates of the map) or by weighting an integral over  $x$  by the *invariant density*  $\rho(x)$ . The invariant density  $\rho(x)dx$  is the probability that a point on a long trajectory will lie between  $x$  and  $x + dx$ . To find it numerically, we iterate a typical point<sup>25</sup>  $x_0$  a thousand or so times ( $N_{\text{transient}}$ ) to find a point  $x_a$  on the attractor, and then collect a long trajectory of perhaps a million points ( $N_{\text{cycles}}$ ). A histogram of this trajectory gives  $\rho(x)$ . Averaging over this density is manifestly the same as a time average over the trajectory of a million points. We call  $\rho(x)$  invariant because it is left the same under the mapping  $f$ ; iterating our million-point approximation for  $\rho$  once under  $f$  only removes the first point  $x_a$  and adds one extra point to the end.

(b) Invariant density. Set  $\mu = 1$ ; iterate  $f$  many times, and form a histogram of values giving the density  $\rho(x)$  of points along the trajectory. You should find that points  $x$  near the boundaries are approached more often than points near the center.

*Analytics.* Using the fact that the long-time average  $\rho(x)$  must be independent of time, verify for  $\mu = 1$  that the density of points is<sup>26</sup>

$$\rho(x) = \frac{1}{\pi\sqrt{x(1-x)}}. \quad (4.14)$$

*Plot this theoretical curve with your numerical histogram.* (Hint: The points in a range  $dx$  around a point  $x$  map under  $f$  to a range  $dy = f'(x)dx$  around the image  $y = f(x)$ . Each iteration maps two points  $x_a$  and  $x_b = 1 - x_a$  to  $y$ , and thus maps all the density  $\rho(x_a)|dx_a|$  and

<sup>23</sup>We also study this map in Exercises 5.9, 5.16, and 12.9.

<sup>24</sup>For many-dimensional mappings, a sufficient criterion for stability is that all the eigenvalues of the Jacobian have magnitude smaller than one. A continuous time evolution  $dy/dt = F(y)$  will be stable if  $dF/dy$  is smaller than zero, or (for multidimensional systems) if the Jacobian  $DF$  has eigenvalues whose real parts are all less than zero.

<sup>25</sup>For example, we must not choose an unstable fixed-point or unstable periodic orbit!

<sup>26</sup>You need not derive the factor  $1/\pi$ , which normalizes the probability density to one.

$\rho(x_b)|dx_b|$  into  $dy$ . Hence the probability  $\rho(y) dy$  must equal  $\rho(x_a)|dx_a| + \rho(x_b)|dx_b|$ , so

$$\rho(f(x_a)) = \rho(x_a)/|f'(x_a)| + \rho(x_b)/|f'(x_b)|. \tag{4.15}$$

Substitute eqn 4.14 into eqn 4.15. You will need to factor a polynomial.)

Mathematicians call this probability density  $\rho(x) dx$  the *invariant measure* on the attractor.<sup>27</sup> To get the long-term average of any function  $O(x)$ , one can use

$$\langle O \rangle = \int O(x)\rho(x) dx. \tag{4.16}$$

To a mathematician, a measure is a way of weighting different regions when calculating integrals—precisely our  $\rho(x) dx$ . Notice that, for the case of an attracting fixed-point, we would have  $\rho(x) = \delta(x^*)$ .<sup>28</sup>

*Cusps in the invariant density.* At values of  $\mu$  slightly smaller than one, our mapping has a rather complex invariant density.

(c) Find the invariant density (as described above) for  $\mu = 0.9$ . Make your trajectory length  $N_{\text{cycles}}$  big enough and the bin size small enough to see the interesting structures. Notice that the attractor no longer fills the whole range  $(0, 1)$ ; locate roughly where the edges are. Notice also the cusps in  $\rho(x)$  at the edges of the attractor, and also at places inside the attractor (called boundaries, see [64]). Locate some of the more prominent cusps.

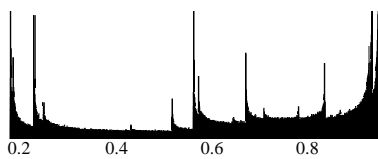


Fig. 4.4 Invariant density in the chaotic region ( $\mu = 0.95$ ).

*Analytics of cusps.* Notice that  $f'(1/2) = 0$ , so by eqn 4.15 we know that  $\rho(f(x)) \geq \rho(x)/|f'(x)|$  must have a singularity near  $x = 1/2$ ; all the points near  $x = 1/2$  are squeezed together and folded to one side by  $f$ . Further iterates of this singularity produce more cusps; the crease after one fold stays a crease after being further stretched and kneaded.

(d) Set  $\mu = 0.9$ . Calculate  $f(1/2)$ ,  $f(f(1/2))$ , ... and compare these iterates to the locations of the edges and cusps from part (c). (You may wish to include them both on the same plot.)

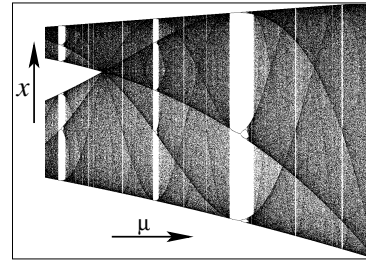


Fig. 4.5 Bifurcation diagram in the chaotic region. Notice the boundary lines threading through the diagram, images of the crease formed by the folding at  $x = 1/2$  in our map (see [64]).

*Bifurcation diagram.* The evolution of the attractor and its invariant density as  $\mu$  varies are plotted in the *bifurcation diagram*, which is shown for large  $\mu$  in Fig. 4.5. One of the striking features in this plot are the sharp boundaries formed by the cusps.

(e) Bifurcation diagram. Plot the attractor (duplicating Fig. 4.5) as a function of  $\mu$ , for  $0.8 < \mu < 1$ . (Pick regularly-spaced  $\delta\mu$ , run  $n_{\text{transient}}$  steps, record  $n_{\text{cycles}}$  steps, and plot. After the routine is working, you should be able to push  $n_{\text{transient}}$  and  $n_{\text{cycles}}$  both larger than 100, and  $\delta\mu < 0.01$ .)

On the same plot, for the same  $\mu$ s, plot the first eight images of  $x = 1/2$ , that is,  $f(1/2), f(f(1/2)), \dots$ . Are the boundaries you see just the cusps? What happens in the bifurcation diagram when two boundaries touch? (See [64].)

(4.4) **Jupiter! and the KAM theorem.** (Astrophysics, Mathematics) ③

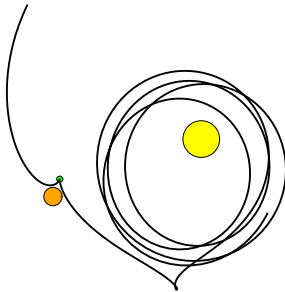
See also the Jupiter web pages [120].

The foundation of statistical mechanics is the *ergodic hypothesis*: any large system will explore the entire energy surface. We focus on large systems because it is well known that many systems with a few interacting particles are definitely not ergodic.

<sup>27</sup>There are actually many possible invariant measures on some attractors; this one is the SRB measure (John Guckenheimer, private communication).

<sup>28</sup>The case of a fixed-point then becomes mathematically a measure with a point mass at  $x^*$ .

The classic example of a non-ergodic system is the Solar System. Jupiter has plenty of energy to send the other planets out of the Solar System. Most of the phase-space volume of the energy surface has eight planets evaporated and Jupiter orbiting the Sun alone; the ergodic hypothesis would doom us to one long harsh winter. So, the big question is: why has the Earth not been kicked out into interstellar space?



**Fig. 4.6 The Earth's trajectory** around the Sun if Jupiter's mass is abruptly increased by about a factor of 100.

Mathematical physicists have studied this problem for hundreds of years. For simplicity, they focused on the *three-body problem*: for example, the Sun, Jupiter, and the Earth. The early (failed) attempts tried to do perturbation theory in the strength of the interaction between planets. Jupiter's gravitational force on the Earth is not tiny, though; if it acted as a constant brake or accelerator, our orbit would be seriously perturbed in a few thousand years. Jupiter's effects must cancel out over time rather perfectly...

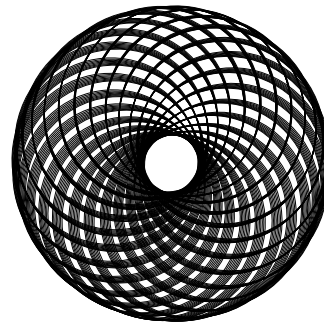
This exercise is mostly discussion and exploration; only a few questions need to be answered. Download the program *Jupiter* from the computer exercises portion of the text web site [129]. Check that Jupiter does not seem to send the Earth out of the Solar System. Try increasing Jupiter's mass to 35 000 Earth masses.

Start the program over again (or reset Jupiter's mass back to 317.83 Earth masses). View Earth's trajectory, run for a while, and zoom in to see the small effects of Jupiter on the Earth. Note that the Earth's position shifts depending on whether Jupiter is on the near or far side of the Sun.

(a) Estimate the fraction that the Earth's radius from the Sun changes during the first Jovian year (about 11.9 years). How much does this fractional variation increase over the next hundred Jovian years?

Jupiter thus warps Earth's orbit into a kind of spiral around a tube. This orbit in physical three-dimensional space is a projection of the tube in  $6N$ -dimensional phase space. The tube in phase space already exists for massless planets...

Let us start in the non-interacting planet approximation (where Earth and Jupiter are assumed to have zero mass). Both Earth's orbit and Jupiter's orbit then become circles, or more generally ellipses. The field of topology does not distinguish an ellipse from a circle; any stretched, 'wiggled' rubber band is a circle so long as it forms a curve that closes into a loop. Similarly, a torus (the surface of a doughnut) is topologically equivalent to any closed surface with one hole in it (like the surface of a coffee cup, with the handle as the hole). Convince yourself in this non-interacting approximation that Earth's orbit remains topologically a circle in its six-dimensional phase space.<sup>29</sup>



**Fig. 4.7 Torus.** The Earth's orbit around the Sun after adiabatically increasing the Jovian mass to 50 000 Earth masses.

(b) In the non-interacting planet approximation, what topological surface is it in the eighteen-dimensional phase space that contains the trajectory of the three bodies? Choose between (i) sphere, (ii) torus, (iii) Klein bottle, (iv) two-hole torus, and (v) complex projective plane. (Hint: It is a circle cross a circle, parameterized by two independent angles—one representing the time during Earth's year, and one representing

<sup>29</sup>Hint: Plot the orbit in the  $(x, y)$ ,  $(x, p_x)$ , and other planes. It should look like the projection of a circle along various axes.

the time during a Jovian year. Feel free to look at Fig. 4.7 and part (c) before committing yourself, if pure thought is not enough.) *About how many times does Earth wind around this surface during each Jovian year?* (This ratio of years is called the *winding number*.)

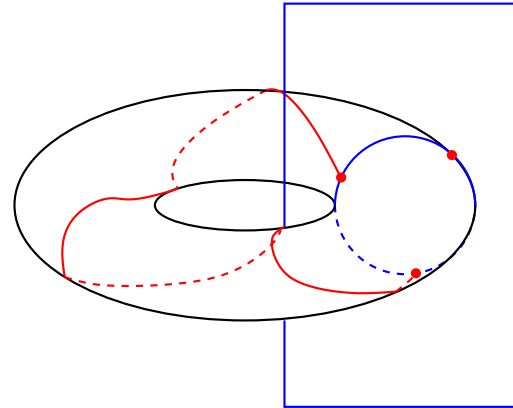
The mathematical understanding of the three-body problem was only solved in the past hundred years or so, by Kolmogorov, Arnol'd, and Moser. Their proof focuses on the topological integrity of this tube in phase space (called now the KAM torus). They were able to prove stability if the winding number (Jupiter year over Earth year) is sufficiently irrational.<sup>30</sup> More specifically, they could prove in this case that for sufficiently small planetary masses there is a distorted torus in phase space, near the unperturbed one, around which the planets spiral around with the same winding number (Fig. 4.7).

(c) *About how large can you make Jupiter's mass before Earth's orbit stops looking like a torus (Fig. 4.6)? (Restart each new mass at the same initial conditions; otherwise, your answer will depend upon the location of Jupiter in the sky when you begin.) Admire the remarkable trajectory when the mass becomes too heavy.*

Thus, for 'small' Jovian masses, the trajectory in phase space is warped and rotated a bit, so that its toroidal shape is visible looking at Earth's position alone. (The circular orbit for zero Jovian mass is looking at the torus on edge.)

The fact that the torus is not destroyed immediately is a serious problem for statistical mechanics! The orbit does not ergodically explore the entire allowed energy surface. This is a counterexample to Boltzmann's ergodic hypothesis. That means that time averages are not equal to averages over the energy surface; our climate would be very unpleasant, on the average, if our orbit were ergodic.

Let us use a Poincaré section to explore these tori, and the chaotic regions between them. If a dynamical system keeps looping back in phase space, one can take a cross-section of phase space and look at the mapping from that cross-section back into itself (see Fig. 4.8).



**Fig. 4.8** The Poincaré section of a torus is a circle. The dynamics on the torus becomes a mapping of the circle onto itself.

The Poincaré section shown in Fig. 4.8 is a planar cross-section in a three-dimensional phase space. Can we reduce our problem to an interesting problem with three phase-space coordinates? The original problem has an eighteen-dimensional phase space. In the center of mass frame it has twelve interesting dimensions. If we restrict the motion to a plane, it reduces to eight dimensions. If we assume that the mass of the Earth is zero (the *restricted* planar three-body problem) we have five relevant coordinates (Earth  $xy$  positions and velocities, and the location of Jupiter along its orbit). If we remove one more variable by going to a rotating coordinate system that rotates with Jupiter, the current state of our model can be described with four numbers: two positions and two momenta for the Earth. We can remove another variable by confining ourselves to a fixed 'energy'. The true energy of the Earth is not conserved (because Earth feels a periodic potential), but there is a conserved quantity which is like the energy in the rotating frame; more details are described on the web site [120] under 'Description of the three-body problem'. This leaves us with a trajectory in three dimensions (so, for small Jovian masses, we have a torus embedded in a three-dimensional space). Finally, we take a Poincaré cross-section; we plot a point of the trajectory every time Earth passes directly between

<sup>30</sup>A 'good' irrational number  $x$  cannot be approximated by rationals  $p/q$  to better than  $\propto 1/q^2$ : given a good irrational  $x$ , there is a  $C > 0$  such that  $|x - p/q| > C/q^2$  for all integers  $p$  and  $q$ . Almost all real numbers are good irrationals, and the KAM theorem holds for them. For those readers who have heard of continued fraction expansions, the best approximations of  $x$  by rationals are given by truncating the continued fraction expansion. Hence the most irrational number is the *golden mean*,  $(1 + \sqrt{5})/2 = 1/(1 + 1/(1 + 1/(1 + \dots)))$ .

Jupiter and the Sun. We plot the distance to Jupiter along the horizontal axis, and the velocity component towards Jupiter along the vertical axis; the perpendicular component of the velocity is not shown (and is determined by the ‘energy’). Set the view to Poincaré. Set Jupiter’s mass to 2000, and run for 1000 years. You should see two nice elliptical cross-sections of the torus. As you increase the mass (resetting to the original initial conditions) watch the toroidal cross-sections as they break down. Run for a few thousand years at  $M_J = 22\,000M_e$ ; notice that the toroidal cross-section has become three circles.

Fixing the mass at  $M_J = 22\,000M_e$ , let us explore the dependence of the planetary orbits on the initial condition. Set up a chaotic trajectory ( $M_J = 22\,000M_e$ ) and observe the Poincaré section. Launch trajectories at various locations in the Poincaré view at fixed ‘energy’.<sup>31</sup> You can thus view the trajectories on a two-dimensional cross-section of the three-dimensional constant-‘energy’ surface.

Notice that many initial conditions slowly fill out closed curves. These are KAM tori that have been squashed and twisted like rubber bands.<sup>32</sup> Explore until you find some orbits that seem to fill out whole regions; these represent *chaotic* orbits.<sup>33</sup>

(d) *If you can do a screen capture, print out a Poincaré section with initial conditions both on KAM tori and in chaotic regions; label each.* See Fig. 4.3 for a small segment of the picture you should generate.

It turns out that proving that Jupiter’s effects cancel out depends on Earth’s smoothly averaging over the surface of the torus. If Jupiter’s year is a rational multiple of Earth’s year, the orbit closes after a few years and you do not average over the whole torus; only a closed spiral. Rational winding numbers, we now know, lead to chaos when the interactions are turned on; the large chaotic region you found above is associated with an unperturbed orbit with a winding ratio of 3:1 (hence the three circles). Disturbingly, the rational numbers are dense; between any two KAM tori there are chaotic regions, just because between any two irrational numbers there are rational ones. It is even worse; it turns out that numbers which are extremely close to rational (Liouville numbers like  $1 + 1/10 + 1/10^{10} + 1/10^{10^{10}} + \dots$ ) may also lead to chaos. It was amazingly tricky to prove that lots of tori survive nonetheless. You can imagine why this took hundreds of years to understand (especially without computers to illustrate the tori and chaos graphically).

<sup>31</sup>This is probably done by clicking on the point in the display, depending on implementation. In the current implementation, this launches a trajectory with that initial position and velocity towards Jupiter; it sets the perpendicular component of the velocity to keep the current ‘energy’. Choosing a point where energy cannot be conserved, the program complains.

<sup>32</sup>Continue if the trajectory does not run long enough to give you a complete feeling for the cross-section; also, increase the time to run. Zoom in and out.

<sup>33</sup>Notice that the chaotic orbit does not throw the Earth out of the Solar System. The chaotic regions near infinity and near our initial condition are not connected. This may be an artifact of our low-dimensional model; in other larger systems it is believed that all chaotic regions (on a connected energy surface) are joined through *Arnol’d diffusion*.





# Entropy



Entropy is the most influential concept to arise from statistical mechanics. What does it mean? Can we develop an intuition for it?

We shall see in this chapter that entropy has three related interpretations.<sup>1</sup> *Entropy measures the disorder in a system*; in Section 5.2 we will see this using the entropy of mixing and the residual entropy of glasses. *Entropy measures our ignorance about a system*; in Section 5.3 we will give examples from non-equilibrium systems and information theory. But we will start in Section 5.1 with the original interpretation, that grew out of the nineteenth century study of engines, refrigerators, and the end of the Universe. *Entropy measures the irreversible changes in a system*.

## 5.1 Entropy as irreversibility: engines and the heat death of the Universe

The early 1800s saw great advances in understanding motors and engines. In particular, scientists asked a fundamental question: how efficient can an engine be? The question was made more difficult because there were two relevant principles<sup>2</sup> to be discovered: energy is conserved and entropy always increases.<sup>3</sup>

For some kinds of engines, only energy conservation is important. For example, there are electric motors that convert electricity into mechanical work (running an electric train), and generators that convert mechanical work (from a rotating windmill) into electricity.<sup>4</sup> For these electromechanical engines, the absolute limitation is given by the conservation of energy: the motor cannot generate more energy in mechanical work than is consumed electrically, and the generator cannot generate more electrical energy than is input mechanically. An ideal electromechanical engine can convert all the energy from one form to another.

Steam engines are more complicated. Scientists in the early 1800s were figuring out that heat is a form of energy. A steam engine, running a power plant or an old-style locomotive, transforms a fraction of the heat energy from the hot steam (the ‘hot bath’) into electrical energy or work, but some of the heat energy always ends up ‘wasted’—dumped into the air or into the cooling water for the power plant (the ‘cold bath’). In fact, if the only limitation on heat engines was conservation of energy, one would be able to make a motor using the heat energy from

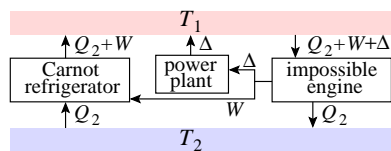
<b>5.1 Entropy as irreversibility: engines and the heat death of the Universe</b>	<b>77</b>
<b>5.2 Entropy as disorder</b>	<b>81</b>
<b>5.3 Entropy as ignorance: information and memory</b>	<b>85</b>

<sup>1</sup>Equilibrium is a word with positive connotations, presumably because it allows us to compute properties easily. Entropy and the quantities it measures—disorder, ignorance, uncertainty—are words with negative connotations, presumably because entropy interferes with making efficient heat engines. Notice that these connotations are not always reliable; in information theory, for example, having high Shannon entropy is good, reflecting better compression of data.

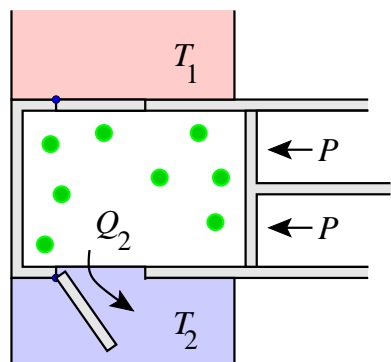
<sup>2</sup>These are the first and second laws of thermodynamics, respectively (Section 6.4).

<sup>3</sup>Some would be pedantic and say only that entropy never decreases, since a system in equilibrium has constant entropy. The phrase ‘entropy always increases’ has a ring to it, though.

<sup>4</sup>Electric motors are really the same as generators run in reverse; turning the shaft of an electric motor can generate electricity.



**Fig. 5.1 Perpetual motion and Carnot.** How to use an engine which produces  $\Delta$  more work than the Carnot cycle to build a perpetual motion machine doing work  $\Delta$  per cycle.



**Fig. 5.2 Prototype heat engine.** A piston with external exerted pressure  $P$ , moving through an insulated cylinder. The cylinder can be put into thermal contact with either of two heat baths: a hot bath at temperature  $T_1$  (say, a coal fire in a power plant) and a cold bath at  $T_2$  (say water from a cold lake). During one cycle of the piston in and out, heat energy  $Q_1$  flows into the piston, mechanical energy  $W$  is done on the external world by the piston, and heat energy  $Q_2$  flows out of the piston into the cold bath.

<sup>5</sup>This postulate is one formulation of the second law of thermodynamics. It is equivalent to the more standard version, that entropy always increases.

a rock, getting both useful work and a very cold rock.

There is something fundamentally less useful about energy once it becomes heat. By spreading out the energy among all the atoms in a macroscopic chunk of material, not all of it can be retrieved again to do useful work. The energy is more useful for generating power when divided between hot steam and a cold lake, than in the form of water at a uniform, intermediate warm temperature. Indeed, most of the time when we use mechanical or electrical energy, the energy ends up as heat, generated from friction or other dissipative processes.

The equilibration of a hot and cold body to two warm bodies in an isolated system is *irreversible*; one cannot return to the original state without inputting some kind of work from outside the system. Carnot, publishing in 1824, realized that the key to producing the most efficient possible engine was to avoid irreversibility. A heat engine run in reverse is a refrigerator; it consumes mechanical work or electricity and uses it to pump heat from a cold bath to a hot one. A reversible heat engine would be able to run forward generating work by transferring heat from the hot to the cold bath, and then run backward using the same work to pump the heat back into the hot bath.

If you had an engine more efficient than a reversible one, you could run it side by side with a reversible engine running as a refrigerator (Fig. 5.1). The pair of engines would together generate work by extracting energy from the hot bath (as from our rock, above) without adding heat to the cold one. After we used this work, we could dump the extra heat from friction back into the hot bath, getting a perpetual motion machine that did useful work without consuming anything. In thermodynamics *we postulate that such perpetual motion machines are impossible*.<sup>5</sup> By calculating the properties of this reversible engine, Carnot placed a fundamental limit on the efficiency of heat engines and discovered what would later be called the entropy.

Carnot considered a prototype heat engine (Fig. 5.2), built from a piston with external pressure  $P$ , two heat baths at a hot temperature  $T_1$  and a cold temperature  $T_2$ , and some type of gas inside the piston. During one cycle of his engine heat  $Q_1$  flows out of the hot bath, heat  $Q_2$  flows into our cold bath, and net work  $W = Q_1 - Q_2$  is done by the piston on the outside world. To make his engine reversible Carnot must avoid (i) friction, (ii) letting hot things touch cold things, (iii) letting systems at high pressure expand into systems at low pressure, and (iv) moving the walls of the container too quickly (emitting sound or shock waves).

Carnot, a theorist, could ignore the practical difficulties. He imagined a frictionless piston which ran through a cycle at arbitrarily low velocities. The piston was used both to extract work from the system and to raise and lower the temperature. Carnot connected the gas thermally to each bath only when its temperature agreed with the bath, so his engine was fully reversible.

The Carnot cycle moves the piston in and out in four steps (Fig. 5.3).

- (a→b) The compressed gas is connected to the hot bath, and the piston moves outward at a varying pressure; heat  $Q_1$  flows in to maintain

the gas at temperature  $T_1$ .

- (b→c) The piston expands further at varying pressure, cooling the gas to  $T_2$  without heat transfer.
- (c→d) The expanded gas in the piston is connected to the cold bath and compressed; heat  $Q_2$  flows out maintaining the temperature at  $T_2$ .
- (d→a) The piston is compressed, warming the gas to  $T_1$  without heat transfer, returning it to the original state.

Energy conservation tells us that the net heat energy flowing into the piston,  $Q_1 - Q_2$ , must equal the work done on the outside world  $W$ :

$$Q_1 = Q_2 + W. \quad (5.1)$$

The work done by the piston is the integral of the force exerted times the distance. The force is the piston surface area times the pressure, and the distance times the piston surface area is the volume change, giving the geometrical result

$$W = \int F dx = \int (F/A)(A dx) = \int_{\text{cycle}} P dV = \text{area inside } PV \text{ loop}. \quad (5.2)$$

That is, if we plot  $P$  versus  $V$  for the four steps of our cycle, the area inside the resulting closed loop is the work done by the piston on the outside world (Fig. 5.3).

Carnot realized that all reversible heat engines working with the same hot and cold bath had to produce exactly the same amount of work for a given heat flow (since they are all perfectly efficient). This allowed him to fill the piston with the simplest possible material (a monatomic ideal gas), for which he knew the relation between pressure, volume, and temperature. We saw in Section 3.5 that the ideal gas equation of state is

$$PV = Nk_B T \quad (5.3)$$

and that its total energy is its kinetic energy, given by the equipartition theorem

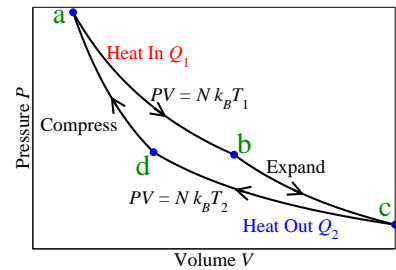
$$E = \frac{3}{2} Nk_B T = \frac{3}{2} PV. \quad (5.4)$$

Along a→b where we add heat  $Q_1$  to the system, we have  $P(V) = Nk_B T_1/V$ . Using energy conservation, we have

$$Q_1 = E_b - E_a + W_{ab} = \frac{3}{2} P_b V_b - \frac{3}{2} P_a V_a + \int_a^b P dV. \quad (5.5)$$

But  $P_a V_a = Nk_B T_1 = P_b V_b$ , so the first two terms cancel; the last term can be evaluated, giving

$$Q_1 = \int_a^b \frac{Nk_B T_1}{V} dV = Nk_B T_1 \log \left( \frac{V_b}{V_a} \right). \quad (5.6)$$



**Fig. 5.3 Carnot cycle  $P$ - $V$  diagram.** The four steps in the Carnot cycle: a→b, heat in  $Q_1$  at constant temperature  $T_1$ ; b→c, expansion without heat flow; c→d, heat out  $Q_2$  at constant temperature  $T_2$ ; and d→a, compression without heat flow to the original volume and temperature.

Similarly,

$$Q_2 = Nk_B T_2 \log \left( \frac{V_c}{V_d} \right). \quad (5.7)$$

For the other two steps in our cycle we need to know how the ideal gas behaves under expansion without any heat flow in or out. Again, using energy conservation on a small segment of the path, the work done for a small volume change  $-P dV$  must equal the change in energy  $dE$ . Using eqn 5.3,  $-P dV = -(Nk_B T/V) dV$ , and using eqn 5.4,  $dE = \frac{3}{2} Nk_B dT$ , so  $dV/V = -\frac{3}{2} dT/T$ . Integrating both sides from  $b$  to  $c$ , we find

$$\int_b^c \frac{dV}{V} = \log \left( \frac{V_c}{V_b} \right) = \int_b^c -\frac{3}{2} \frac{dT}{T} = -\frac{3}{2} \log \left( \frac{T_2}{T_1} \right), \quad (5.8)$$

so  $V_c/V_b = (T_1/T_2)^{3/2}$ . Similarly,  $V_d/V_a = (T_1/T_2)^{3/2}$ . Thus  $V_c/V_b = V_d/V_a$ , and hence

$$\frac{V_c}{V_d} = \frac{V_c}{V_b} \frac{V_b}{V_d} = \frac{V_d}{V_a} \frac{V_b}{V_d} = \frac{V_b}{V_a}. \quad (5.9)$$

We can use the volume ratios from the insulated expansion and compression (eqn 5.9) to substitute into the heat flow (eqns 5.6 and 5.7) to find

$$\frac{Q_1}{T_1} = Nk_B \log \left( \frac{V_b}{V_a} \right) = Nk_B \log \left( \frac{V_c}{V_d} \right) = \frac{Q_2}{T_2}. \quad (5.10)$$

This was Carnot's fundamental result; his cycle, and hence any reversible engine, satisfies the law

$$\frac{Q_1}{T_1} = \frac{Q_2}{T_2}. \quad (5.11)$$

Later scientists decided to define<sup>6</sup> the *entropy change* to be this ratio of heat flow to temperature:

$$\Delta S_{\text{thermo}} = \frac{Q}{T}. \quad (5.12)$$

For a reversible engine the entropy flow from the hot bath into the piston  $Q_1/T_1$  equals the entropy flow from the piston into the cold bath  $Q_2/T_2$ ; no entropy is created or destroyed. Any real engine will create<sup>7</sup> net entropy during a cycle; no engine can reduce the net amount of entropy in the Universe.

The irreversible increase of entropy is not a property of the microscopic laws of nature. In particular, the microscopic laws of nature are *time-reversal invariant*: the laws governing the motion of atoms are the same whether time is running backward or forward.<sup>8</sup> The microscopic laws do not tell us the *arrow of time*. The direction of time in which entropy increases is our definition of the *future*.<sup>9</sup>

This confusing point may be illustrated by considering the game of pool or billiards. Neglecting friction, the trajectories of the pool balls are also time-reversal invariant. If the velocities of the balls were reversed half-way through a pool shot, they would retrace their motions, building

<sup>6</sup>The thermodynamic entropy is derived with a heat flow  $\Delta E = Q$  at a fixed temperature  $T$ , so our statistical mechanics definition of temperature  $1/T = \partial S/\partial E$  (from eqn 3.29) is equivalent to the thermodynamics definition of entropy  $1/T = \Delta S/\Delta E \Rightarrow \Delta S = Q/T$  (eqn 5.12).

<sup>7</sup>For example, a small direct heat leak from the hot bath to the cold bath of  $\delta$  per cycle would generate

$$\frac{Q_2 + \delta}{T_2} - \frac{Q_1 + \delta}{T_1} = \delta \left( \frac{1}{T_2} - \frac{1}{T_1} \right) > 0 \quad (5.13)$$

entropy per cycle.

<sup>8</sup>More correctly, the laws of nature are only invariant under CPT: changing the direction of time (T) along with inverting space (P) and changing matter to antimatter (C). Radioactive beta decay and other weak interaction forces are not invariant under time-reversal. The basic conundrum for statistical mechanics is the same, though: we cannot tell from the microscopic laws if we are matter beings living forward in time or antimatter beings living backward in time in a mirror. Time running backward would appear strange macroscopically even if we were made of antimatter.

<sup>9</sup>In electromagnetism, the fact that waves radiate away from sources more often than they converge upon sources is a closely related distinction of past from future.

up all the velocity into one ball that then would stop as it hit the cue stick. In pool, the feature that distinguishes forward from backward time is the greater order at early times; all the momentum starts in one ball, and is later distributed among all the balls involved in collisions. Similarly, the only reason we can resolve the arrow of time—distinguish the future from the past—is that the Universe started in an unusual, low-entropy state, and is irreversibly moving towards equilibrium.<sup>10</sup> (One would think that the Big Bang was high entropy! It was indeed hot (high momentum-space entropy), but it was dense (low configurational entropy), and in total the entropy was lower<sup>11</sup> than it is now.) The temperature and pressure differences we now observe to be moving towards equilibrium as time increases are echoes of this low-entropy state in the distant past.

The cosmic implications of the irreversible increase of entropy were not lost on the intellectuals of the nineteenth century. In 1854, Helmholtz predicted the *heat death of the Universe*: he suggested that as the Universe ages all energy will become heat, all temperatures will become equal, and everything will ‘be condemned to a state of eternal rest’. In 1895, H. G. Wells in *The Time Machine* [144, chapter 11] speculated about the state of the Earth in the distant future:

... the sun, red and very large, halted motionless upon the horizon, a vast dome glowing with a dull heat... The earth had come to rest with one face to the sun, even as in our own time the moon faces the earth... There were no breakers and no waves, for not a breath of wind was stirring. Only a slight oily swell rose and fell like a gentle breathing, and showed that the eternal sea was still moving and living. ... the life of the old earth ebb[s] away...

This gloomy prognosis has been re-examined recently; it appears that the expansion of the Universe may provide loopholes. While there is little doubt that the Sun and the stars will indeed die, it may be possible—if life can evolve to accommodate the changing environments—that civilization, memory, and thought could continue for an indefinite subjective time (Exercise 5.1).

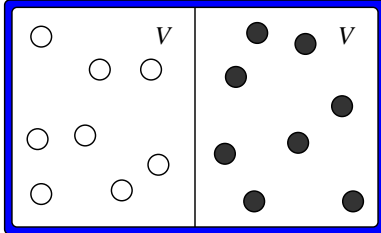
## 5.2 Entropy as disorder

A second intuitive interpretation of entropy is as a measure of the disorder in a system. Scientist mothers tell their children to lower the entropy by tidying their rooms; liquids have higher entropy than crystals intuitively because their atomic positions are less orderly.<sup>12</sup> We illustrate this interpretation by first calculating the *entropy of mixing*, and then discussing the *zero-temperature entropy of glasses*.

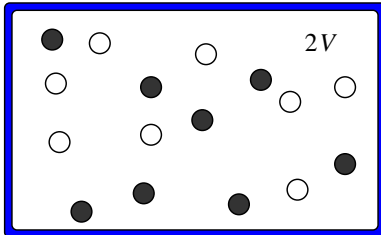
<sup>10</sup>Suppose after waiting a cosmologically long time one observed a spontaneous fluctuation of an equilibrium system into a low-entropy, ordered state. Preceding that time, with extremely high probability, all of our laws of macroscopic physics would appear to run backward. The most probable route building up to an ordered state from equilibrium is the time reverse of the most probable decay of that ordered state back to equilibrium.

<sup>11</sup>In the approximation that the Universe remained in equilibrium as it expanded, the entropy would have remained constant; indeed, the photon entropy did remain constant during the expansion of the Universe (Exercise 7.15). The nuclei did not: primordial nucleosynthesis—the formation of heavier nuclei from protons and neutrons—stalled after a few light elements [143]. (Just as an ideal gas under abrupt expansion is left hotter than it would have been had it done work against the adiabatic expansion of a piston, so the photons emitted now by stars changing hydrogen and helium into iron 56 are higher frequency and hotter than the red-shifted photons that would have been emitted from the same processes during a hypothetical equilibrium Big Bang.) It has been argued [104] that the root source of the low-entropy at the Big Bang was the very flat (low-entropy) initial state of space-time.

<sup>12</sup>There are interesting examples of systems that appear to develop more order as their entropy (and temperature) rises. These are systems where adding order of one, visible type (say, crystalline or orientational order) allows increased disorder of another type (say, vibrational disorder). Entropy is a precise measure of disorder, but is not the only possible or useful measure.



**Fig. 5.4 Unmixed atoms.** The pre-mixed state:  $N/2$  white atoms on one side,  $N/2$  black atoms on the other.



**Fig. 5.5 Mixed atoms.** The mixed state:  $N/2$  white atoms and  $N/2$  black atoms scattered through the volume  $2V$ .

<sup>13</sup>This has no social policy implications; the entropy of mixing for a few billion humans would not power an eye blink.

### 5.2.1 Entropy of mixing: Maxwell's demon and osmotic pressure

Scrambling an egg is a standard example of irreversibility; you cannot re-separate the yolk from the white. A model for scrambling is given in Figs 5.4 and 5.5: the mixing of two different types of particles. Here the entropy change upon mixing is a measure of increased disorder.

Consider a volume separated by a partition into two equal volumes of volume  $V$ . There are  $N/2$  undistinguished ideal gas white atoms on one side of the partition, and  $N/2$  undistinguished ideal gas black atoms on the other side. The configurational entropy of this system (eqn 3.55, ignoring the momentum space parts) is

$$S_{\text{unmixed}} = 2k_B \log[V^{N/2}/(N/2)!], \quad (5.14)$$

just twice the configurational entropy of  $N/2$  undistinguished atoms in a volume  $V$ . We assume that the black and white atoms have the same masses and the same total energy. Now consider the entropy change when the partition is removed, and the two sets of atoms are allowed to mix. Because the temperatures and pressures from both sides are equal, removing the partition does not involve any irreversible sound emission or heat transfer; any entropy change is due to the mixing of the white and black atoms. In the desegregated state,<sup>13</sup> the entropy has increased to

$$S_{\text{mixed}} = 2k_B \log[(2V)^{N/2}/(N/2)!], \quad (5.15)$$

twice the entropy of  $N/2$  undistinguished atoms in a volume  $2V$ . Since  $\log(2^m x) = m \log 2 + \log x$ , the change in entropy due to the mixing is

$$\Delta S_{\text{mixing}} = S_{\text{mixed}} - S_{\text{unmixed}} = k_B \log 2^N = Nk_B \log 2. \quad (5.16)$$

We gain  $k_B \log 2$  in entropy every time we place an atom into one of two boxes without looking which box we chose. More generally, we might define a counting entropy:

$$S_{\text{counting}} = k_B \log(\text{number of configurations}) \quad (5.17)$$

for systems with a discrete number of equally-likely configurations.

This kind of discrete choice arises often in statistical mechanics. In equilibrium quantum mechanics (for a finite system) the states are quantized; so adding a new (non-interacting) particle into one of  $m$  degenerate states adds  $k_B \log m$  to the entropy. In communications theory (Section 5.3.2, Exercises 5.14 and 5.15), each bit transmitted down your channel can be in one of two states, so a random stream of bits of length  $N$  has  $\Delta S = k_S N \log 2$ .<sup>14</sup>

In more general cases, the states available to one particle depend strongly on the configurations of the other particles. Nonetheless, the equilibrium entropy still measures the logarithm of the number of different states that the total system could be in. For example, our equilibrium statistical mechanics entropy  $S_{\text{equil}}(E) = k_B \log(\Omega(E))$  (eqn 3.25)

<sup>14</sup>The Shannon constant  $k_S$  is defined in Section 5.3.2.

is the logarithm of the number of states of energy  $E$ , with phase-space volume  $h^{3N}$  allocated to each state.

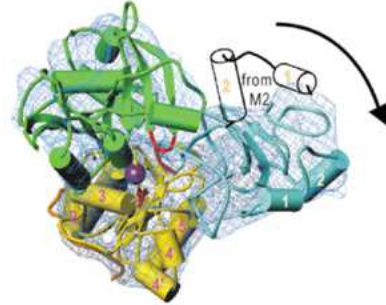
What would happen if we removed a partition separating  $N/2$  black atoms on one side from  $N/2$  black atoms on the other? The initial entropy is the same as above  $S_{\text{unmixed}}^{\text{BB}} = 2k_B \log[V^{N/2}/(N/2)!]$ , but the final entropy is now  $S_{\text{mixed}}^{\text{BB}} = k_B \log((2V)^N/N!)$ . Notice we have  $N!$  rather than the  $((N/2)!)^2$  from eqn 5.15, since all of our particles are now undistinguished. Now  $N! = (N)(N-1)(N-2)(N-3)\dots$  and  $((N/2)!)^2 = (N/2)(N/2)[(N-2)/2][(N-2)/2]\dots$ ; they roughly differ by  $2^N$ , canceling the entropy change due to the volume doubling. Indeed, expanding the logarithm using Stirling's formula  $\log n! \approx n \log n - n$  we find the entropy per atom is unchanged.<sup>15</sup> This is why we introduced the  $N!$  term for undistinguished particles in Section 3.2.1; without it the entropy would decrease by  $N \log 2$  whenever we split a container into two pieces.<sup>16</sup>

How can we intuitively connect this entropy of mixing with the thermodynamic entropy of pistons and engines in Section 5.1? Can we use our mixing entropy to do work? To do so we must discriminate between the two kinds of atoms. Suppose that the barrier separating the two walls in Fig. 5.4 was a membrane that was impermeable to black atoms but allowed white ones to cross. Since both black and white atoms are ideal gases, the white atoms would spread uniformly to fill the entire system, while the black atoms would remain on one side. This would lead to a pressure imbalance; if the semipermeable wall was used as a piston, work could be extracted as the black chamber was enlarged to fill the total volume.<sup>17</sup>

Suppose we had a more active discrimination? Maxwell introduced the idea of an intelligent 'finite being' (later termed *Maxwell's demon*) that would operate a small door between the two containers. When a black atom approaches the door from the left or a white atom approaches from the right the demon would open the door; for the reverse situations the demon would leave the door closed. As time progresses, this active sorting would re-segregate the system, lowering the entropy. This is not a concern for thermodynamics, since running a demon is an entropy generating process! Indeed, one can view this thought experiment as giving a fundamental limit on demon efficiency, putting a lower bound on how much entropy an intelligent being must create in order to engage in this kind of sorting process (Fig. 5.6 and Exercise 5.2).

### 5.2.2 Residual entropy of glasses: the roads not taken

Unlike a crystal, in which each atom has a set position, a glass will have a completely different configuration of atoms each time it is formed. That is, the glass has a *residual entropy*; as the temperature goes to absolute zero, the glass entropy does not vanish, but rather equals  $k_B \log \Omega_{\text{glass}}$ , where  $\Omega_{\text{glass}}$  is the number of zero-temperature configurations in which the glass might be trapped.



**Fig. 5.6 Ion pump.** An implementation of Maxwell's demon in biology is  $\text{Na}^+/\text{K}^+$ -ATPase, an enzyme located on the membranes of almost every cell in your body. This enzyme maintains extra potassium ( $\text{K}^+$ ) ions inside the cell and extra sodium ( $\text{Na}^+$ ) ions outside the cell. The enzyme exchanges two  $\text{K}^+$  ions from outside for three  $\text{Na}^+$  ions inside, burning as fuel one *ATP* (adenosine with three phosphates, the fuel of the cell) into *ADP* (two phosphates). When you eat too much salt ( $\text{Na}^+\text{Cl}^-$ ), the extra sodium ions in the blood increase the osmotic pressure on the cells, draw more water into the blood, and increase your blood pressure. The figure (Toyoshima et al., © Nature 2000) shows the structure of the related enzyme calcium ATPase [140]. The arrow shows the shape change as the two  $\text{Ca}^+$  ions are removed.

<sup>15</sup>If you keep Stirling's formula to higher order, you will see that the entropy increases a microscopic amount when you remove the partition. This is due to the number fluctuations on the two sides that are now allowed. See Exercise 5.2 for a small system where this entropy increase is important.

<sup>16</sup>This is often called the Gibbs paradox.

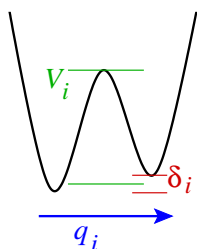
<sup>17</sup>Such semipermeable membranes are quite common, not for gases, but for dilute solutions of ions in water; some ions can penetrate and others cannot. The resulting force on the membrane is called *osmotic pressure*.

<sup>18</sup>Windows are made from soda-lime glass (silica (SiO<sub>2</sub>) mixed with sodium and calcium oxides).

<sup>19</sup>Pyrex<sup>TM</sup> is a borosilicate glass (boron and silicon oxides) with a low thermal expansion, used for making measuring cups that do not shatter when filled with boiling water.

<sup>20</sup>Hard candy is an American usage; in British English they are called *boiled sweets*.

<sup>21</sup>One can measure  $S_{\text{liquid}}(T_\ell)$  by slowly heating a crystal from absolute zero and measuring  $\int_0^{T_\ell} dQ/T$  flowing in.



**Fig. 5.7 Double-well potential.** A model for the potential energy for one coordinate  $q_i$  in a glass; two states separated by a barrier  $V_i$  and with a small energy difference  $\delta_i$ . In equilibrium, the atom is  $\exp(-\delta_i/k_B T)$  less likely to be in the upper well. For barriers  $V_i \gg k_B T$ , the molecule will spend most of its time vibrating in one of the wells, and rarely hop across the barrier.

<sup>23</sup>Atomic vibration times are around  $10^{-12}$  seconds, and cooling times are typically between seconds and years, so the cooling rate is indeed slow compared to microscopic times.

<sup>22</sup>The glass transition is not a sharp phase transition; the liquid grows thicker (more viscous) as it is cooled, with slower and slower dynamics, until the cooling rate becomes too fast for the atomic rearrangements needed to maintain equilibrium to keep up. At that point, there is a smeared-out transition as the viscosity effectively becomes infinite and the glass becomes bonded together. Our model is not a good description of the glass transition, but is a rather accurate model for the continuing thermal rearrangements ( $\beta$ -relaxation) at temperatures below the glass transition, and an excellent model for the quantum dynamics (tunneling centers) which dominate many properties of glasses below a few degrees Kelvin. See Section 12.3.4 for how little we understand glasses.

*What is a glass?* Glasses are disordered like liquids, but are rigid like crystals. They are not in equilibrium; they are formed when liquids are cooled too fast to form the crystalline equilibrium state. You are aware of glasses made from silica, like window glass,<sup>18</sup> and Pyrex<sup>TM</sup>.<sup>19</sup> You also know of some molecular glasses, like hard candy<sup>20</sup> (a glass made of sugar). Many other materials (even metals) can form glasses when cooled quickly.

*How is the residual glass entropy measured?* First, one estimates the entropy of the equilibrium liquid;<sup>21</sup> then one measures the entropy flow  $Q/T$  out from the glass as it is cooled from the liquid down to absolute zero. The difference

$$S_{\text{residual}} = S_{\text{liquid}}(T_\ell) - \int \frac{1}{T} \frac{dQ}{dt} dt = S_{\text{liquid}}(T_\ell) - \int_0^{T_\ell} \frac{1}{T} \frac{dQ}{dT} dT \quad (5.18)$$

gives the residual entropy.

*How big is the residual entropy of a typical glass?* The residual entropy is of the order of  $k_B$  per molecular unit of the glass (SiO<sub>2</sub> or sugar molecule, for example). This means that the number of glassy configurations  $e^{S/k_B}$  is enormous (Exercise 5.11).

*How is it possible to measure the number of glass configurations the system did not choose?* The glass is, after all, in one particular configuration. How can measuring the heat flow  $Q(t)$  out of the liquid as it freezes into one glassy state be used to measure the number  $\Omega_{\text{glass}}$  of possible glassy states? In other words, how exactly is the statistical mechanics definition of entropy  $S_{\text{stat}} = k_B \log \Omega_{\text{glass}}$  related to the thermodynamic definition  $\Delta S_{\text{thermo}} = Q/T$ ?

To answer this question, we need a simplified model of how a glass might fall out of equilibrium as it is cooled.<sup>22</sup> We view the glass as a collection of independent molecular units. Each unit has a double-well potential energy: along some internal coordinate  $q_i$  there are two minima with an energy difference  $\delta_i$  and separated by an energy barrier  $V_i$  (Fig. 5.7). This internal coordinate might represent a rotation of a sugar molecule in a candy, or a shift in the location of an oxygen atom in a SiO<sub>2</sub> window glass.

Consider the behavior of one of these double-well degrees of freedom. As we cool our system, the molecular unit will be thermally excited over its barrier more and more slowly. So long as the cooling rate  $\Gamma_{\text{cool}}$  is small compared to this hopping rate, our unit will remain in equilibrium. However, at the temperature  $T_i$  where the two rates cross for our unit the transitions between the wells will not keep up and our molecular unit will freeze into position. If the cooling rate  $\Gamma_{\text{cool}}$  is very slow compared to the molecular vibration frequencies (as it almost always is)<sup>23</sup> the



hopping rate will change rapidly with temperature, and our system will freeze into place in a small range of temperature near  $T_i$ .<sup>24</sup>

Our frozen molecular unit has a population in the upper well given by the Boltzmann factor  $e^{-\delta_i/k_B T_i}$  times the population in the lower well. Hence, those units with  $\delta_i \gg k_B T_i$  will be primarily in the ground state (and hence already roughly in equilibrium). However, consider those  $N$  units with barriers high compared to the asymmetry,  $\delta_i \ll k_B T_i$ ; as the glass is cooled, one by one these units randomly freeze into one of two states (Fig. 5.8). For these units, both states will be roughly equally populated when they fall out of equilibrium, so each will contribute about  $k_B \log 2$  to the residual entropy. Thus the  $N$  units with  $T_i > \delta_i/k_B$  will contribute about  $k_B \log 2 \sim k_B$  to the statistical residual entropy  $S_{\text{stat}}$ .<sup>25</sup>

Is the thermodynamic entropy flow  $\Delta S = \int dQ/T$  out of the glass also smaller than it would be in equilibrium? Presumably so, since some of the energy remains trapped in the glass within those units left in their upper wells. Is the residue the same as the statistical residual entropy? Those units with  $k_B T_i \ll \delta_i$  which equilibrate into the lower well before they freeze will contribute the same amount to the entropy flow into the heat bath as they would in an equilibrium system. On the other hand, those units with  $k_B T \gg \delta_i$  will each fail (half the time) to release their energy  $\delta_i$  to the heat bath, when compared to an infinitely slow (equilibrium) cooling. Since during an equilibrium cooling this heat would be transferred to the bath at a temperature around  $\delta_i/k_B$ , the missing entropy flow for that unit is  $\Delta Q/T \sim \delta_i/(\delta_i/k_B) \sim k_B$ . Again, the  $N$  units each contribute around  $k_B$  to the (experimentally measured) thermodynamic residual entropy  $S_{\text{thermo}}$ .

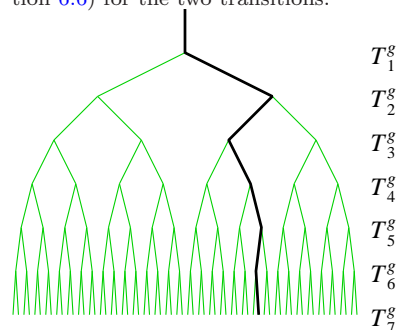
Thus the heat flow into a *particular* glass configuration counts the number of roads not taken by the glass on its cooling voyage.

### 5.3 Entropy as ignorance: information and memory

The most general interpretation of entropy is as a measure of our *ignorance*<sup>26</sup> about a system. The equilibrium state of a system maximizes the entropy because we have lost all information about the initial conditions except for the conserved quantities; maximizing the entropy maximizes our ignorance about the details of the system. The entropy of a glass, or of our mixture of black and white atoms, is a measure of the number of arrangements the atoms could be in, given our ignorance.<sup>27</sup>

This interpretation—that entropy is not a property of the system, but of our knowledge about the system<sup>28</sup> (represented by the ensemble of possibilities)—cleanly resolves many otherwise confusing issues. The atoms in a glass are in a definite configuration, which we could measure using some futuristic X-ray holographic technique. If we did so, our ignorance would disappear, and the residual entropy would become zero for us.<sup>29</sup> We could in principle use our knowledge of the glass atom

<sup>24</sup>This can be derived straightforwardly using Arrhenius rates (Section 6.6) for the two transitions.



**Fig. 5.8 Roads not taken by the glass.** The branching path of glassy states in our model. The entropy (both statistical and thermodynamic) is proportional to the number of branchings the glass chooses between as it cools. A particular glass will take one trajectory through this tree as it cools; nonetheless the thermodynamic entropy measures the total number of states.

<sup>25</sup>We are losing factors like  $\log 2$  because we are ignoring those units with  $k_B T_i \sim \delta_i$ , which freeze into partly occupied states that are not equally occupied, a case we have not treated yet. The thermodynamic and statistical entropies of course agree quantitatively if calculated properly, apart from non-equilibrium effects.

<sup>26</sup>In information theory they use the alternative term *uncertainty*, which has misleading connotations from quantum mechanics; Heisenberg uncertainty has no associated entropy.

<sup>27</sup>Again, entropy is a precise measure of ignorance, but not necessarily a sensible one for all purposes. In particular, entropy does not distinguish the *utility* of the information. Isothermally compressing a mole of gas to half its volume decreases our ignorance by  $10^{23}$  bits—a far larger change in entropy than would be produced by memorizing all the written works of human history.

<sup>28</sup>The entropy of an *equilibrium* system remains purely a property of the composition of the system, because our knowledge is fixed (at zero).

<sup>29</sup>The X-ray holographic process must, naturally, create at least as much entropy during the measurement as the glass loses.

positions to extract extra useful work out of the glass, not available before measuring the positions (Exercise 5.2).

So far, we have confined ourselves to cases where our ignorance is maximal, where all allowed configurations are equally likely. What about systems where we have partial information, where some configurations are more probable than others? There is a powerful generalization of the definition of entropy to general probability distributions, which we will introduce in Section 5.3.1 for traditional statistical mechanical systems. In Section 5.3.2 we will show that this non-equilibrium entropy provides a generally useful measure of our ignorance about a wide variety of systems, with broad applications outside of traditional physics.

### 5.3.1 Non-equilibrium entropy

The second law of thermodynamics tells us that entropy increases. We want a definition of entropy for systems that are out of equilibrium, so we can watch it grow. In general, we may describe our partial knowledge about such a system as a probability distribution  $\rho$ , defining an ensemble of states.

Let us start with a probability distribution among a discrete set of states. We know from Section 5.2.1 that the entropy for  $M$  equally-likely states (eqn 5.17) is  $S(M) = k_B \log M$ . In this case, the probability of each state is  $p_i = 1/M$ . If we write  $S(M) = -k_B \log(1/M) = -k_B \langle \log(p_i) \rangle$ , we get an appealing generalization for the counting entropy for cases where  $p_i$  is not constant:

$$S_{\text{discrete}} = -k_B \langle \log p_i \rangle = -k_B \sum_i p_i \log p_i. \quad (5.19)$$

We shall see in Section 5.3.2 and Exercise 5.17 that this is the correct generalization of entropy to systems out of equilibrium.

What about continuum distributions? Any non-equilibrium state of a classical Hamiltonian system can be described with a probability density  $\rho(\mathbb{P}, \mathbb{Q})$  on phase space. The non-equilibrium entropy then becomes

$$\begin{aligned} S_{\text{nonequil}} &= -k_B \langle \log \rho \rangle = -k_B \int \rho \log \rho \\ &= -k_B \int_{E < \mathcal{H}(\mathbb{P}, \mathbb{Q}) < E + \delta E} \frac{d\mathbb{P} d\mathbb{Q}}{h^{3N}} \rho(\mathbb{P}, \mathbb{Q}) \log \rho(\mathbb{P}, \mathbb{Q}). \end{aligned} \quad (5.20)$$

In the case of the microcanonical ensemble where  $\rho_{\text{equil}} = 1/(\Omega(E)\delta E)$ , the non-equilibrium definition of the entropy is shifted from our equilibrium definition  $S = k_B \log \Omega$  by a negligible amount  $k_B \log(\delta E)/N$  per particle:<sup>30</sup>

$$\begin{aligned} S_{\text{micro}} &= -k_B \log \rho_{\text{equil}} = k_B \log(\Omega(E)\delta E) \\ &= k_B \log(\Omega(E)) + k_B \log(\delta E). \end{aligned} \quad (5.21)$$

For quantum systems, the non-equilibrium entropy will be written in terms of the density matrix  $\rho$  (Section 7.1):

$$S_{\text{quantum}} = -k_B \text{Tr}(\rho \log \rho). \quad (5.22)$$

<sup>30</sup>The arbitrary choice of the width of the energy shell in the microcanonical ensemble is thus related to the arbitrary choice of the zero for the entropy of a classical system. Unlike the (extensive) shift due to the units of phase space (Section 3.5), this shift is microscopic.

Finally, notice that  $S_{\text{noneq}}$  and  $S_{\text{quantum}}$  are defined for the microscopic laws of motion, which (Section 5.1) are time-reversal invariant. We can thus guess that these microscopic entropies will be time independent, since microscopically the system does not know in which direction of time entropy should increase.<sup>31</sup> No information is lost (in principle) by evolving a closed system in time. Entropy (and our ignorance) increases only in theories where we ignore or exclude some degrees of freedom. These degrees of freedom may be external (information flowing into the environment or heat bath) or internal (information flowing into irrelevant microscopic degrees of freedom which are ignored in a coarse-grained theory).

<sup>31</sup>You can show this explicitly in Exercises 5.7 and 7.4.

### 5.3.2 Information entropy

Understanding ignorance is central to many fields! Entropy as a measure of ignorance has been useful in everything from the shuffling of cards (Exercise 5.13) to reconstructing noisy images. For these other applications, the connection with temperature is unimportant, so we do not need to make use of Boltzmann's constant. Instead, we normalize the entropy with the constant  $k_S = 1/\log(2)$ :

$$S_S = -k_S \sum_i p_i \log p_i = - \sum_i p_i \log_2 p_i, \quad (5.23)$$

so that entropy is measured in *bits*.<sup>32</sup>

This normalization was introduced by Shannon [131], and the formula 5.23 is referred to as Shannon entropy in the context of *information theory*. Shannon noted that this entropy, applied to the ensemble of possible messages or images, can be used to put a fundamental limit on the amount they can be compressed<sup>33</sup> to efficiently make use of disk space or a communications channel (Exercises 5.14 and 5.15). A low-entropy data set is highly predictable; given the stream of data so far, we can predict the next transmission with some confidence. In language, twins and long-married couples can often complete sentences for one another. In image transmission, if the last six pixels were white the region being depicted is likely to be a white background, and the next pixel is also likely to be white. We need only transmit or store data that violates our prediction. The entropy measures our ignorance, how likely the best predictions about the rest of the message are to be wrong.

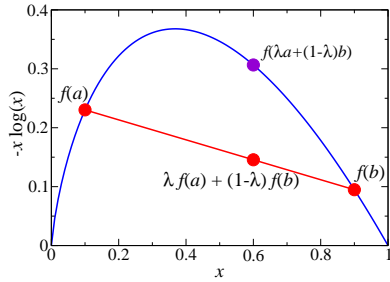
<sup>32</sup>Each bit doubles the number of possible states  $\Omega$ , so  $\log_2 \Omega$  is the number of bits.

<sup>33</sup>Lossless compression schemes (files ending in gif, png, zip, and gz) remove the redundant information in the original files, and their efficiency is limited by the entropy of the ensemble of files being compressed (Exercise 5.15). Lossy compression schemes (files ending in jpg, mpg, and mp3) also remove information that is thought to be unimportant for humans looking at or listening to the files (Exercise 5.14).

Entropy is so useful in these various fields because it is the unique (continuous) function that satisfies three key properties.<sup>34</sup> In this section, we will explain what these three properties are and why they are natural for any function that measures ignorance. We will also show that our non-equilibrium Shannon entropy satisfies these properties. In Exercise 5.17 you can show that this entropy is the only function to do so.

<sup>34</sup>Unique, that is, up to the overall constant  $k_S$  or  $k_B$ .

To take a tangible example of ignorance, suppose your room-mate has lost their keys, and they are asking for your advice. You want to measure the room-mate's progress in finding the keys by measuring your



**Fig. 5.9 Entropy is concave.** For  $x \geq 0$ ,  $f(x) = -x \log x$  is strictly convex downward (concave). That is, for  $0 < \lambda < 1$ , the linear interpolation lies below the curve:

$$f(\lambda a + (1 - \lambda)b) \geq \lambda f(a) + (1 - \lambda)f(b). \quad (5.24)$$

We know  $f$  is concave because its second derivative,  $-1/x$ , is everywhere negative.

<sup>35</sup>In Exercise 6.6 we will ask you to show that the Shannon entropy  $S_S$  is an extremum when all probabilities are equal. Here we provide a stronger proof that it is a global maximum, using the convexity of  $x \log x$  (note 36).

ignorance with some function  $S_I$ . Suppose there are  $\Omega$  possible sites  $A_k$  that they might have left the keys, which you estimate have probabilities  $p_k = P(A_k)$ , with  $\sum_1^\Omega p_i = 1$ .

What are the three key properties we want our ignorance function  $S_I(p_1, \dots, p_\Omega)$  to have?

(1) *Entropy is maximum for equal probabilities.* Without further information, surely the best plan is for your room-mate to look first at the most likely site, which maximizes  $p_i$ . Your ignorance must therefore be maximal if all  $\Omega$  sites have equal likelihood:

$$S_I\left(\frac{1}{\Omega}, \dots, \frac{1}{\Omega}\right) > S_I(p_1, \dots, p_\Omega) \quad \text{unless } p_i = \frac{1}{\Omega} \text{ for all } i. \quad (5.25)$$

Does the Shannon entropy obey eqn 5.25, property (1)?<sup>35</sup> We notice that the function  $f(p) = -p \log p$  is concave (convex downward, Fig. 5.9). For a concave function  $f$ , the average value of  $f(p)$  over a set of points  $p_k$  is less than or equal to  $f$  evaluated at the average of the  $p_k$ :<sup>36</sup>

$$\frac{1}{\Omega} \sum_k f(p_k) \leq f\left(\frac{1}{\Omega} \sum_k p_k\right). \quad (5.27)$$

But this tells us that

$$\begin{aligned} S_S(p_1, \dots, p_\Omega) &= -k_S \sum p_k \log p_k = k_S \sum f(p_k) \\ &\leq k_S \Omega f\left(\frac{1}{\Omega} \sum_k p_k\right) = k_S \Omega f\left(\frac{1}{\Omega}\right) \\ &= -k_S \sum_1^\Omega \frac{1}{\Omega} \log\left(\frac{1}{\Omega}\right) = S_S\left(\frac{1}{\Omega}, \dots, \frac{1}{\Omega}\right). \end{aligned} \quad (5.28)$$

(2) *Entropy is unaffected by extra states of zero probability.* If there is no possibility that the keys are in your shoe (site  $A_\Omega$ ), then your ignorance is no larger than it would have been if you had not included your shoe in the list of possible sites:

$$S_I(p_1, \dots, p_{\Omega-1}, 0) = S_I(p_1, \dots, p_{\Omega-1}). \quad (5.29)$$

The Shannon entropy obeys property (2) because  $p_\Omega \log p_\Omega \rightarrow 0$  as  $p_\Omega \rightarrow 0$ .

<sup>36</sup>Equation 5.27 is Jensen's inequality. It can be proven by induction from the definition of concave (eqn 5.24). For  $\Omega = 2$ , we use  $\lambda = 1/2$ ,  $a = p_1$ , and  $b = p_2$  to see that  $f((p_1 + p_2)/2) \geq (f(p_1) + f(p_2))/2$ . For general  $\Omega$ , we use  $\lambda = (\Omega - 1)/\Omega$ ,  $a = (\sum_1^{\Omega-1} p_k)/(\Omega - 1)$ , and  $b = p_\Omega$  to see that

$$\begin{aligned} f\left(\frac{\sum_{k=1}^\Omega p_k}{\Omega}\right) &= f\left(\frac{\Omega - 1}{\Omega} \frac{\sum_1^{\Omega-1} p_k}{\Omega - 1} + \frac{1}{\Omega} p_\Omega\right) \geq \frac{\Omega - 1}{\Omega} f\left(\frac{\sum_1^{\Omega-1} p_k}{\Omega - 1}\right) + \frac{1}{\Omega} f(p_\Omega) \\ &\geq \frac{\Omega - 1}{\Omega} \left(\sum_{k=1}^{\Omega-1} \frac{1}{\Omega - 1} f(p_k)\right) + \frac{1}{\Omega} f(p_\Omega) = \frac{1}{\Omega} \sum_{k=1}^\Omega f(p_k), \end{aligned} \quad (5.26)$$

where we have used the truth of eqn 5.27 for  $\Omega - 1$  to inductively prove it for  $\Omega$ .

(3) *Entropy change for conditional probabilities.* This last property for our ignorance function demands a new concept, *conditional probability*.<sup>37</sup>

To aid in the search, you are likely to ask the room-mate where they were when they last saw the keys. Suppose there are  $M$  locations  $B_\ell$  that the room-mate may have been (opening the apartment door, driving the car, in the basement laundry room, ...), with probabilities  $q_\ell$ . Surely the likelihood that the keys are currently in a coat pocket is larger if the room-mate was outdoors when the keys were last seen. Let  $r_{k\ell} = P(A_k \text{ and } B_\ell)$  be the probability the keys are at site  $k$  and were last seen at location  $\ell$ . Let<sup>38</sup>

$$c_{k\ell} = P(A_k|B_\ell) = \frac{P(A_k \text{ and } B_\ell)}{P(B_\ell)} = \frac{r_{k\ell}}{q_\ell} \quad (5.30)$$

be the conditional probability, given that the keys were last seen at  $B_\ell$ , that the keys are now at site  $A_k$ . Naturally

$$\sum_k P(A_k|B_\ell) = \sum_k c_{k\ell} = 1; \quad (5.31)$$

wherever  $[\ell]$  they were last seen the keys are now *somewhere* with probability one.

Before you ask your room-mate where the keys were last seen, you have ignorance  $S_I(A) = S_I(p_1, \dots, p_\Omega)$  about the site of the keys, and ignorance  $S_I(B) = S_I(q_1, \dots, q_M)$  about the location they were last seen. You have a joint ignorance about the two questions given by the ignorance function applied to all  $\Omega \times M$  conditional probabilities:

$$\begin{aligned} S_I(AB) &= S_I(r_{11}, r_{12}, \dots, r_{1M}, r_{21}, \dots, r_{\Omega M}) \\ &= S_I(c_{11}q_1, c_{12}q_2, \dots, c_{1M}q_M, c_{21}q_1, \dots, c_{\Omega M}q_M). \end{aligned} \quad (5.32)$$

After the room-mate answers your question, your ignorance about the location last seen is reduced to zero (decreased by  $S_I(B)$ ). If the location last seen was in the laundry room (site  $B_\ell$ ), the probability for the keys being at  $A_k$  shifts to  $c_{k\ell}$  and your ignorance about the site of the keys is now

$$S_I(A|B_\ell) = S_I(c_{1\ell}, \dots, c_{\Omega\ell}). \quad (5.33)$$

So, your combined ignorance has decreased from  $S_I(AB)$  to  $S_I(A|B_\ell)$ .

We can measure the usefulness of your question by the expected amount that it decreases your ignorance about where the keys reside. The expected ignorance after the question is answered is given by weighting the ignorance after each answer  $B_\ell$  by the probability  $q_\ell$  of that answer:

$$\langle S_I(A|B_\ell) \rangle_B = \sum_\ell q_\ell S_I(A|B_\ell). \quad (5.34)$$

This leads us to the third key property for an ignorance function. If we start with the joint distribution  $AB$ , and then measure  $B$ , it would be tidy if, on average, your joint ignorance declined by your original ignorance of  $B$ :

$$\langle S_I(A|B_\ell) \rangle_B = S_I(AB) - S_I(B). \quad (5.35)$$

<sup>37</sup>If you find the discussion of conditional probability subtle, and the resulting third property for the ignorance function (eqn 5.35) less self evident than the first two properties, you are in good company. Generalizations of the entropy that modify this third condition are sometimes useful.

<sup>38</sup>The conditional probability  $P(A|B)$  (read as ‘the probability of  $A$  given  $B$ ’) times the probability of  $B$  is the probability of  $A$  and  $B$  both occurring, so  $P(A|B)P(B) = P(A \text{ and } B)$  (or equivalently  $c_{k\ell}q_\ell = r_{k\ell}$ ).

Does the Shannon entropy satisfy eqn 5.35, property (3)? The conditional probability  $S_S(A|B_\ell) = -k_S \sum_k c_{k\ell} \log c_{k\ell}$ , since  $c_{k\ell}$  is the probability distribution for the  $A_k$  sites given location  $\ell$ . So,

$$\begin{aligned}
 S_S(AB) &= -k_S \sum_{k\ell} c_{k\ell} q_\ell \log(c_{k\ell} q_\ell) \\
 &= -k_S \left( \sum_{k\ell} c_{k\ell} q_\ell \log(c_{k\ell}) + \sum_{k\ell} c_{k\ell} q_\ell \log(q_\ell) \right) \\
 &= \sum_\ell q_\ell \left( -k_S \sum_k c_{k\ell} \log(c_{k\ell}) \right) - k_S \sum_\ell q_\ell \log(q_\ell) \left( \sum_k c_{k\ell} \right) \\
 &= \sum_\ell q_\ell S_S(A|B_\ell) + S_S(B) \\
 &= \langle S_S(A|B_\ell) \rangle_B + S_S(B), \tag{5.36}
 \end{aligned}$$

and the Shannon entropy does satisfy condition (3).

If  $A$  and  $B$  are uncorrelated (for example, if they are measurements on uncoupled systems), then the probabilities of  $A$  will not change upon measuring  $B$ , so  $S_I(A|B_\ell) = S_I(A)$ . Then our third condition implies  $S_I(AB) = S_I(A) + S_I(B)$ ; our ignorance of uncoupled systems is additive. This is simply the condition that *entropy is extensive*. We argued that the entropy of weakly-coupled subsystems in equilibrium must be additive in Section 3.3. Our third condition implies that this remains true for uncorrelated systems in general.

---

## Exercises

The exercises explore four broad aspects of entropy.

Entropy provides fundamental limits. We explore entropic limits to thought in *Life and the heat death of the Universe*, to measurement in *Burning information and Maxwellian demons*, to computation in *Reversible computation*, and to memory in *Black hole thermodynamics*. We exercise our understanding of entropic limits to engine efficiency in *P-V diagram* and *Carnot refrigerator*.

Entropy is an emergent property. We argued from time-reversal invariance that a complete microscopic description of a closed system cannot lose information, and hence the entropy must be a constant; you can show this explicitly in *Does entropy increase?* Entropy increases because the information stored in the initial conditions is rapidly made irrelevant by chaotic motion; this is illustrated pictorially by *The Arnol'd cat map* and numerically (in a dissipative system) in *Chaos, Lyapunov, and entropy increase*. Entropy also increases in coarse-grained

theories which ignore microscopic degrees of freedom; we see one example of this in *Entropy increases: diffusion*.

Entropy has tangible experimental consequences. In *Entropy of glasses* we explore how an experiment can put upper and lower bounds on the entropy due to our massive ignorance about the zero-temperature atomic configuration in a glass. In *Rubber band* we find that the entropy in a random walk can exert forces.

Entropy is a general measure of ignorance, with widespread applications to other fields. In *How many shuffles?* we apply it to card shuffling (where ignorance is the goal). In *Information entropy and Shannon entropy* we explore the key role entropy plays in communication theory and compression algorithms. In *Fractal dimensions* we find a useful characterization of fractal sets in dissipative systems that is closely related to the entropy. Finally, in *Deriving entropy* you can reproduce the famous proof that the Shannon entropy is the unique measure of

ignorance with the three key properties explicated in Section 5.3.2.

(5.1) **Life and the heat death of the Universe.** (Astrophysics) ②

Freeman Dyson [36] discusses how living things might evolve to cope with the cooling and dimming we expect during the heat death of the Universe.

Normally one speaks of living things as beings that consume energy to survive and proliferate. This is of course not correct; energy is conserved, and cannot be consumed. *Living beings intercept entropy flows*; they use low-entropy sources of energy (e.g., high-temperature solar radiation for plants, candy bars for us) and emit high-entropy forms of the same energy (body heat). Dyson ignores the survival and proliferation issues; he's interested in getting a lot of thinking in before the Universe ends. He presumes that an intelligent being generates a fixed entropy  $\Delta S$  per thought.<sup>39</sup>

*Energy needed per thought.* Assume that the being draws heat  $Q$  from a hot reservoir at  $T_1$  and radiates it away to a cold reservoir at  $T_2$ .

(a) *What is the minimum energy  $Q$  needed per thought, in terms of  $\Delta S$  and  $T_2$ ? You may take  $T_1$  very large.* Related formulæ:  $\Delta S = Q_2/T_2 - Q_1/T_1$ ;  $Q_1 - Q_2 = W$  (energy is conserved).

*Time needed per thought to radiate energy.* Dyson shows, using theory not important here, that the power radiated by our intelligent-being-as-entropy-producer is no larger than  $CT_2^3$ , a constant times the cube of the cold temperature.<sup>40</sup>

(b) *Write an expression for the maximum rate of thoughts per unit time  $dH/dt$  (the inverse of the time  $\Delta t$  per thought), in terms of  $\Delta S$ ,  $C$ , and  $T_2$ .*

*Number of thoughts for an ecologically efficient being.* Our Universe is expanding; the radius  $R$  grows roughly linearly in time  $t$ . The microwave background radiation has a characteristic temperature  $\Theta(t) \sim R^{-1}$  which is getting lower as the Universe expands; this red-shift is due to the Doppler effect. An ecologically efficient being would naturally try to use as little heat as possible, and so wants to choose  $T_2$  as small as pos-

sible. It cannot radiate heat at a temperature below  $T_2 = \Theta(t) = A/t$ .

(c) *How many thoughts  $H$  can an ecologically efficient being have between now and time infinity, in terms of  $\Delta S$ ,  $C$ ,  $A$ , and the current time  $t_0$ ? Time without end: greedy beings.* Dyson would like his beings to be able to think an infinite number of thoughts before the Universe ends, but consume a finite amount of energy. He proposes that his beings need to be profligate in order to get their thoughts in before the world ends; he proposes that they radiate at a temperature  $T_2(t) \sim t^{-3/8}$  which falls with time, but not as fast as  $\Theta(t) \sim t^{-1}$ .

(d) *Show that with Dyson's cooling schedule, the total number of thoughts  $H$  is infinite, but the total energy consumed  $U$  is finite.*

We should note that there are many refinements on Dyson's ideas. There are potential difficulties that may arise, like quantum limits to cooling and proton decay. And there are different challenges depending on the expected future of the Universe; a big crunch (where the Universe collapses back on itself) demands that we adapt to heat and pressure, while dark energy may lead to an accelerating expansion and a rather lonely Universe in the end.

(5.2) **Burning information and Maxwellian demons.** (Computer science) ③

Is there a minimum energy cost for taking a measurement? In this exercise, we shall summarize the work of Bennett [15], as presented in Feynman [40, chapter 5].

We start by addressing again the connection between information entropy and thermodynamic entropy. Can we burn information as fuel?

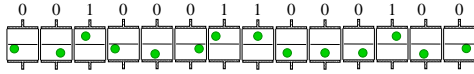
Consider a really frugal digital memory tape, with one atom used to store each bit (Fig. 5.10). The tape is a series of boxes, with each box containing one ideal gas atom. The box is split into two equal pieces by a removable central partition. If the atom is in the top half of the box, the tape reads one; if it is in the bottom half the tape reads zero. The side walls are frictionless pistons that may be used to push the atom around.

If we know the atom position in the  $n$ th box, we can move the other side wall in, remove the partition, and gradually retract the piston to its

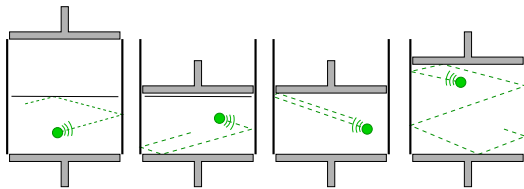
<sup>39</sup>Each thought can be an arbitrarily complex computation; the only entropy necessarily generated is associated with recording the answer (see Exercise 5.3).

<sup>40</sup>The constant scales with the number of electrons in the being, so we can think of our answer  $\Delta t$  as the time per thought per mole of electrons.

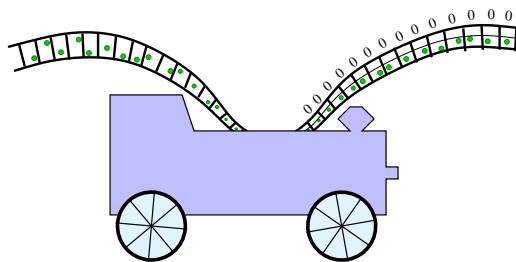
original position (Fig. 5.11)—destroying our information about where the atom is, but extracting useful work.



**Fig. 5.10 Minimalist digital memory tape.** The position of a single ideal gas atom denotes a bit. If it is in the top half of a partitioned box, the bit is one, otherwise it is zero. The side walls of the box are pistons, which can be used to set, reset, or extract energy from the stored bits. The numbers above the boxes are not a part of the tape, they just denote what bit is stored in a given position.



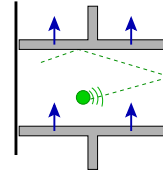
**Fig. 5.11 Expanding piston.** Extracting energy from a known bit is a three-step process: compress the empty half of the box, remove the partition, and retract the piston and extract  $PdV$  work out of the ideal gas atom. (One may then restore the partition to return to an equivalent, but more ignorant, state.) In the process, one loses one bit of information (which side of the the partition is occupied).



**Fig. 5.12 Information-burning engine.** A memory tape can therefore be used to power an engine. If the engine knows or can guess the sequence written on the tape, it can extract useful work in exchange for losing that information.

(a) Burning the information. *Assuming the gas expands at a constant temperature  $T$ , how much work  $\int PdV$  is done by the atom as the piston retracts?*

This is also the minimum work needed to set a bit whose state is currently unknown. However, a *known* bit can be reset for free (Fig. 5.13).



**Fig. 5.13 Pistons changing a zero to a one.**

(b) Rewriting a bit. *Give a sequence of partition insertion, partition removal, and adiabatic side-wall motions that will reversibly convert a bit zero (atom on bottom) into a bit one (atom on top), with no net work done on the system.*

Thus the only irreversible act in using this memory tape occurs when one forgets what is written upon it (equivalent to removing and then reinserting the partition).

(c) Forgetting a bit. *Suppose the atom location in the  $n$ th box is initially known. What is the change in entropy, if the partition is removed and the available volume doubles? Give both the thermodynamic entropy (involving  $k_B$ ) and the information entropy (involving  $k_S = 1/\log 2$ ).*

This entropy is the cost of the missed opportunity of extracting work from the bit (as in part (a)).

What prevents a Maxwellian demon from using an atom in an unknown state to extract work? The demon must first measure which side of the box the atom is on. Early workers suggested that there must be a minimum energy cost to take this measurement, equal to the energy gain extractable from the bit (part (a)). Bennett [15] showed that no energy need be expended in the measurement process.<sup>41</sup> Why does this not violate the second law of thermodynamics?

(d) Demonic states. *After the bit has been burned, is the demon in a known<sup>42</sup> state? What is its entropy? How much energy would it take to return the demon to its original state, at temperature  $T$ ? Is the second law violated?*

<sup>41</sup>He modeled the demon as a two-state system (say, another partitioned box). If the demon starts in a known state, one can copy the state of the box into the demon with no cost in energy or entropy, by adiabatically turning on an appropriate coupling. The demon has now measured the atom position, and can extract work from the pistons.

<sup>42</sup>That is, known to the outside world, not just to the demon.



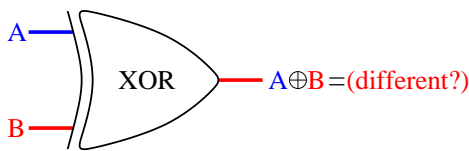
The demon can extract an unlimited amount of useful work from a tape with an unknown bit sequence if it has enough internal states to store the sequence—basically it can copy the information onto a second, internal tape. But the same work must be expended to re-zero this internal tape, preparing it to be used again.

Bennett's insight might seem self-evident; one can always pay for energy from the bath with an increase in entropy. However, it had deep consequences for the theory of computation (Exercise 5.3).

(5.3) **Reversible computation.** (Computer science) ③

Is there a minimum energy cost for computation? Again, this exercise is based on the work of Bennett [15] and Feynman [40, chapters 5 and 6].

A general-purpose computer can be built out of certain elementary logic gates. Many of these gates destroy information.



**Fig. 5.14 Exclusive-or gate.** In logic, an exclusive or (XOR) corresponds to the colloquial English usage of the word: either A or B but not both. An XOR gate outputs a one (true) if the two input bits A and B are different, and outputs a zero (false) if they are the same.

(a) Irreversible logic gates. Consider the XOR gate shown in Fig. 5.14. How many bits of information are lost during the action of this gate? Presuming the four possible inputs are equally probable, what is the minimum work needed to perform this operation, if the gate is run at temperature  $T$ ? (Hint: Just like the demon in Exercise 5.2(d), the gate must pay energy to compress into a more definite state.)

Early workers in this field thought that these logical operations must have a minimum energy cost. Bennett recognized that they could be done with no energy cost by adding extra outputs to the gates. Naturally, keeping track of

these extra outputs involves the use of extra memory storage—he traded an energy cost for a gain in entropy. However, the resulting gates now became *reversible*.

(b) Reversible gate. Add an extra output to the XOR gate, which just copies the state of input A to the first output ( $C = A$ ,  $D = A \oplus B$ ). (This is the Controlled-Not gate, one of three that Feynman uses to assemble a general-purpose computer, see [40, chapter 6])

Make a table, giving the four possible outputs (C, D) of the resulting gate for the four possible inputs  $(A, B) = (00, 01, 10, 11)$ . If we run the outputs (C, D) of the gate into the inputs  $(A', B')$  of another Controlled-Not gate, what net operation is performed?

A completely reversible computer can therefore be constructed out of these new gates. The computer performs the calculation, carefully copies the answer into an output buffer, and then performs the reverse computation. In reversing the computation, all the stored information about the extra bits can be reabsorbed, just as in part (b). The only energy or entropy cost for the computation is involved in writing the answer.

These ideas later led to the subject of *quantum computation*. Quantum computers are naturally reversible, and would be much more powerful for some kinds of computations than ordinary computers.

(5.4) **Black hole thermodynamics.** (Astrophysics) ③

Astrophysicists have long studied *black holes*: the end state of massive stars which are too heavy to support themselves under gravity (see Exercise 7.16). As the matter continues to fall into the center, eventually the escape velocity reaches the speed of light. After this point, the in-falling matter cannot ever communicate information back to the outside. A black hole of mass  $M$  has radius<sup>43</sup>

$$R_s = G \frac{2M}{c^2}, \quad (5.37)$$

where  $G = 6.67 \times 10^{-8} \text{ cm}^3/\text{g s}^2$  is the gravitational constant, and  $c = 3 \times 10^{10} \text{ cm/s}$  is the speed of light.

<sup>43</sup>This is the Schwarzschild radius of the event horizon for a black hole with no angular momentum or charge.

Hawking, by combining methods from quantum mechanics and general relativity, calculated the emission of radiation from a black hole.<sup>44</sup> He found a wonderful result: black holes emit perfect black-body radiation at a temperature

$$T_{\text{bh}} = \frac{\hbar c^3}{8\pi GMk_B}. \quad (5.38)$$

According to Einstein's theory, the energy of the black hole is  $E = Mc^2$ .

(a) Calculate the specific heat of the black hole. The specific heat of a black hole is *negative*. That is, it gets cooler as you add energy to it. In a bulk material, this would lead to an instability; the cold regions would suck in more heat and get colder. Indeed, a population of black holes is unstable; the larger ones will eat the smaller ones.<sup>45</sup>

(b) Calculate the entropy of the black hole, by using the definition of temperature  $1/T = \partial S/\partial E$  and assuming the entropy is zero at mass  $M = 0$ . Express your result in terms of the surface area  $A = 4\pi R_s^2$ , measured in units of the Planck length  $L^* = \sqrt{\hbar G/c^3}$  squared.

As it happens, Bekenstein had deduced this formula for the entropy somewhat earlier, by thinking about analogies between thermodynamics, information theory, and statistical mechanics. On the one hand, when black holes interact or change charge and angular momentum, one can prove in classical general relativity that the area can only increase. So it made sense to assume that the entropy was somehow proportional to the area. He then recognized that if you had some waste material of high entropy to dispose of, you could ship it into a black hole and never worry about it again. Indeed, given that the entropy represents your lack of knowledge about a system, once matter goes into a black hole one can say that our knowledge about it completely vanishes.<sup>46</sup> (More specifically, the entropy of a black hole represents the inaccessibility of all information about what it was built out of.) By carefully dropping various physical systems into a black hole (theoretically) and measuring the area increase compared to the entropy increase,

he was able to deduce these formulæ purely from statistical mechanics.

We can use these results to provide a fundamental bound on memory storage.

(c) Calculate the maximum number of bits that can be stored in a sphere of radius one centimeter.

Finally, in perhaps string theory's first physical prediction, your formula for the entropy (part (b)) was derived microscopically for a certain type of black hole.

(5.5) **Pressure–volume diagram.** (Thermodynamics) ②

A monatomic ideal gas in a piston is cycled around the path in the  $P$ – $V$  diagram in Fig. 5.15. Leg **a** cools at constant volume by connecting to a heat bath at  $T_c$ ; leg **b** heats at constant pressure by connecting to a heat bath at  $T_h$ ; leg **c** compresses at constant temperature while remaining connected to the bath at  $T_h$ .

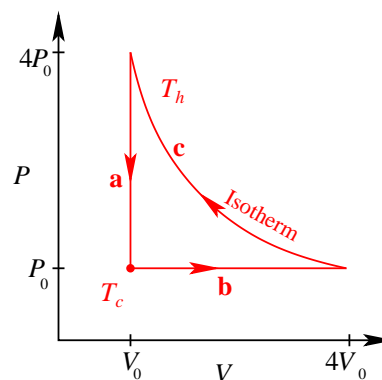


Fig. 5.15  $P$ – $V$  diagram.

Which of the following six statements are true? (T) (F) The cycle is reversible; no net entropy is created in the Universe.

(T) (F) The cycle acts as a refrigerator, using work from the piston to draw energy from the cold bath into the hot bath, cooling the cold bath.

<sup>44</sup>Nothing can leave a black hole; the radiation comes from vacuum fluctuations just outside the black hole that emit particles.

<sup>45</sup>A thermally insulated glass of ice water also has a negative specific heat. The surface tension at the curved ice surface will decrease the coexistence temperature a slight amount (see Section 11.3); the more heat one adds, the smaller the ice cube, the larger the curvature, and the lower the resulting temperature [100].

<sup>46</sup>Except for the mass, angular momentum, and charge. This suggests that baryon number, for example, is not conserved in quantum gravity. It has been commented that when the baryons all disappear, it will be hard for Dyson to build his progeny out of electrons and neutrinos (Exercise 5.1).

(T) (F) The cycle acts as an engine, transferring heat from the hot bath to the cold bath and doing positive net work on the outside world.

(T) (F) The work done per cycle has magnitude  $|W| = P_0 V_0 |4 \log 4 - 3|$ .

(T) (F) The heat transferred into the cold bath,  $Q_c$ , has magnitude  $|Q_c| = (9/2)P_0 V_0$ .

(T) (F) The heat transferred from the hot bath,  $Q_h$ , plus the net work  $W$  done by the piston onto the gas, equals the heat  $Q_c$  transferred into the cold bath.

Related formulae:  $PV = Nk_B T$ ;  $U = (3/2)Nk_B T$ ;  $\Delta S = Q/T$ ;  $W = -\int P dV$ ;  $\Delta U = Q + W$ . Notice that the signs of the various terms depend on convention (heat flow out vs. heat flow in); you should work out the signs on physical grounds.

- (5.6) **Carnot refrigerator.** (Thermodynamics) ②  
Our refrigerator is about  $2\text{ m} \times 1\text{ m} \times 1\text{ m}$ , and has insulation about 3 cm thick. The insulation is probably polyurethane, which has a thermal conductivity of about 0.02 W/m K. Assume that the refrigerator interior is at 270 K, and the room is at 300 K.

(a) How many watts of energy leak from our refrigerator through this insulation?

Our refrigerator runs at 120 V, and draws a maximum of 4.75 amps. The compressor motor turns on every once in a while for a few minutes.

(b) Suppose (i) we do not open the refrigerator door, (ii) the thermal losses are dominated by the leakage through the foam and not through the seals around the doors, and (iii) the refrigerator runs as a perfectly efficient Carnot cycle. How much power on average will our refrigerator need to operate? What fraction of the time will the motor run?

- (5.7) **Does entropy increase?** (Mathematics) ③  
The second law of thermodynamics says that entropy always increases. Perversely, we can show that in an isolated system, no matter what non-equilibrium condition it starts in, entropy calculated with a complete microscopic description stays constant in time. Liouville's theorem tells us that the total derivative of the probability density is zero; following the trajectory of a system, the local probability density never changes. The equilibrium states

have probability densities that only depend on energy and number. Something is wrong; if the probability density starts non-uniform, how can it become uniform?

Show

$$\begin{aligned} \frac{\partial f(\rho)}{\partial t} &= -\nabla \cdot [f(\rho)\mathbb{V}] \\ &= -\sum_{\alpha} \frac{\partial}{\partial p_{\alpha}} (f(\rho)\dot{p}_{\alpha}) + \frac{\partial}{\partial q_{\alpha}} (f(\rho)\dot{q}_{\alpha}), \end{aligned}$$

where  $f$  is any function and  $\mathbb{V} = (\dot{\mathbb{P}}, \dot{\mathbb{Q}})$  is the  $6N$ -dimensional velocity in phase space. Hence (by Gauss's theorem in  $6N$  dimensions), show  $\int (\partial f(\rho)/\partial t) d\mathbb{P} d\mathbb{Q} = 0$ , assuming that the probability density vanishes at large momenta and positions and  $f(0) = 0$ . Show, thus, that the entropy  $S = -k_B \int \rho \log \rho$  is constant in time.

We will see that the quantum version of the entropy is also constant for a Hamiltonian system in Exercise 7.4. Some deep truths are not microscopic; the fact that entropy increases is an emergent property.

- (5.8) **The Arnol'd cat map.** (Mathematics) ③

Why do we think entropy increases? Points in phase space do not just swirl in circles; they get stretched and twisted and folded back in complicated patterns—especially in systems where statistical mechanics seems to hold. Arnol'd, in a take-off on Schrödinger's cat, suggested the following analogy. Instead of a continuous transformation of phase space onto itself preserving  $6N$ -dimensional volume, let us think of an area-preserving mapping of an  $n \times n$  square in the plane into itself (figure 5.16).<sup>47</sup> Consider the mapping (Fig. 5.16)

$$\Gamma \begin{pmatrix} x \\ y \end{pmatrix} = \begin{pmatrix} 2x + y \\ x + y \end{pmatrix} \text{ mod } n. \quad (5.39)$$

Check that  $\Gamma$  preserves area. (It is basically multiplication by the matrix  $M = \begin{pmatrix} 2 & 1 \\ 1 & 1 \end{pmatrix}$ . What is the determinant of  $M$ ?). Show that it takes a square  $n \times n$  (or a picture of  $n \times n$  pixels) and maps it into itself with periodic boundary conditions. (With less cutting and pasting, you can view it as a map from the torus into itself.) As a linear map, find the eigenvalues and eigenvectors. Argue that a small neighborhood (say a circle in the center of the picture) will initially be

<sup>47</sup>More general, nonlinear area-preserving maps of the plane are often studied as Hamiltonian-like dynamical systems. Area-preserving maps come up as Poincaré sections of Hamiltonian systems 4.4, with the area weighted by the inverse of the velocity with which the system passes through the cross-section. They are particularly relevant in studies of high-energy particle accelerators, where the mapping gives a snapshot of the particles after one orbit around the ring.

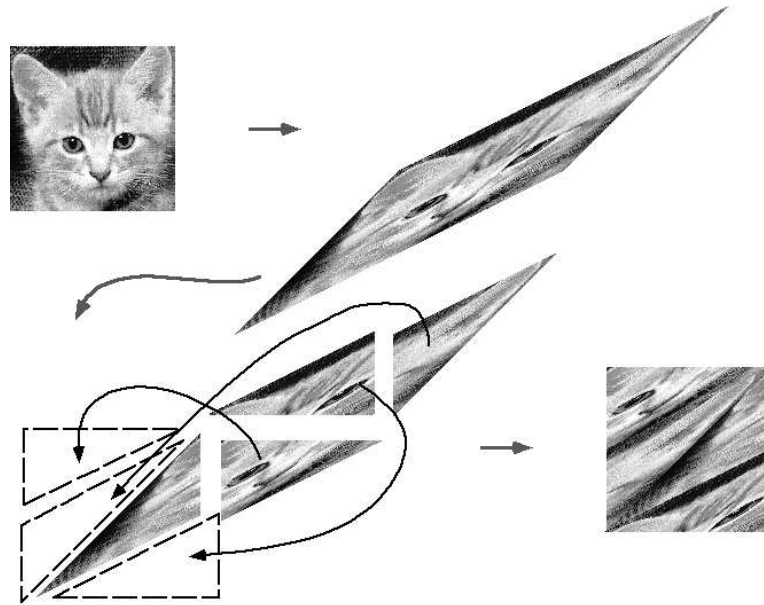


Fig. 5.16 Arnol'd cat transform, from Poon [105]; see the movie too [113].

stretched along an irrational direction into a thin strip (Fig. 5.17).

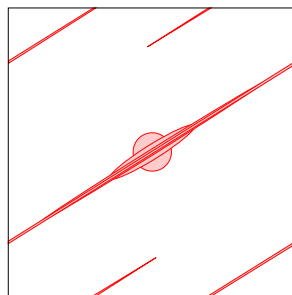


Fig. 5.17 Arnol'd map stretches. A small circular region stretches along an irrational angle under the Arnol'd cat map. The center of the figure is the origin  $x = 0, y = 0$ .

When this thin strip hits the boundary, it gets split into two; in the case of an  $n \times n$  square, further iterations stretch and chop our original circle into a thin line uniformly covering the square. In the pixel case, there are always exactly the

same number of pixels that are black, white, and each shade of gray; they just get so kneaded together that everything looks a uniform color. So, by putting a limit to the resolution of our measurement (rounding errors on the computer, for example), or by introducing any tiny coupling to the external world, the final state can be seen to rapidly approach equilibrium, proofs to the contrary (Exercise 5.7) notwithstanding.

(5.9) **Chaos, Lyapunov, and entropy increase.**<sup>48</sup> (Mathematics, Complexity) ③

Chaotic dynamical systems have *sensitive dependence on initial conditions*. This is commonly described as the ‘butterfly effect’ (due to Lorenz of the Lorenz attractor): the effects of the flap of a butterfly’s wings in Brazil build up with time until months later a tornado in Texas could be launched. In this exercise, we will see this sensitive dependence for a particular system (the

<sup>48</sup>This exercise and the associated software were developed in collaboration with Christopher Myers.

logistic map)<sup>49</sup> and measure the sensitivity by defining the *Lyapunov exponents*. The logistic map takes the interval  $(0, 1)$  into itself:

$$f(x) = 4\mu x(1 - x), \quad (5.40)$$

where the time evolution is given by iterating the map:

$$x_0, x_1, x_2, \dots = x_0, f(x_0), f(f(x_0)), \dots \quad (5.41)$$

In particular, for  $\mu = 1$  it precisely folds the unit interval in half, and stretches it (non-uniformly) to cover the original domain.

The mathematics community lumps together continuous dynamical evolution laws and discrete mappings as both being dynamical systems.<sup>50</sup> The general stretching and folding exhibited by our map is often seen in driven physical systems without conservation laws.

In this exercise, we will focus on values of  $\mu$  near one, where the motion is mostly *chaotic*. Chaos is sometimes defined as motion where the final position depends sensitively on the initial conditions. Two trajectories, starting a distance  $\epsilon$  apart, will typically drift apart in time as  $\epsilon e^{\lambda t}$ , where  $\lambda$  is the Lyapunov exponent for the chaotic dynamics.

Start with  $\mu = 0.9$  and two nearby points  $x_0$  and  $y_0 = x_0 + \epsilon$  somewhere between zero and one. Investigate the two trajectories  $x_0, f(x_0), f(f(x_0)), \dots, f^{[n]}(x_0)$  and  $y_0, f(y_0), \dots$ . How fast do they separate? Why do they stop separating? Estimate the Lyapunov exponent. (Hint:  $\epsilon$  can be a few times the precision of the machine (around  $10^{-17}$  for double-precision arithmetic), so long as you are not near the maximum value of  $f$  at  $x_0 = 0.5$ .)

Many Hamiltonian systems are also chaotic. Two configurations of classical atoms or billiard balls, with initial positions and velocities that are almost identical, will rapidly diverge as the collisions magnify small initial deviations in angle and velocity into large ones. It is this chaotic stretching, folding, and kneading of phase space that is at the root of our explanation that entropy increases.

(5.10) **Entropy increases: diffusion.** ③

We saw that entropy technically does not increase for a closed system, for any Hamiltonian, either classical or quantum. However, we can show that entropy increases for most of the coarse-grained effective theories that we use in practice; when we integrate out degrees of freedom, we provide a means for the information about the initial condition to be destroyed. Here you will show that entropy increases for the diffusion equation.

Let  $\rho(x, t)$  obey the one-dimensional diffusion equation  $\partial\rho/\partial t = D\partial^2\rho/\partial x^2$ . Assume that the density  $\rho$  and all its gradients die away rapidly at  $x = \pm\infty$ .<sup>51</sup>

Derive a formula for the time derivative of the entropy  $S = -k_B \int \rho(x) \log \rho(x) dx$  and show that it strictly increases in time. (Hint: Integrate by parts. You should get an integral of a positive definite quantity.)

(5.11) **Entropy of glasses.** (Condensed matter) ③

Glasses are not really in equilibrium. If you put a glass in an insulated box, it will warm up (very slowly) because of microscopic atomic rearrangements which lower the potential energy. So, glasses do not have a well-defined temperature or specific heat. In particular, the heat flow upon cooling and on heating  $(dQ/dT)(T)$  will not precisely match (although their integrals will agree by conservation of energy).

Thomas and Parks in Fig. 5.18 are making the approximation that the specific heat of the glass is  $dQ/dT$ , the measured heat flow out of the glass divided by the temperature change of the heat bath. They find that the specific heat defined in this way measured on cooling and heating disagree. Assume that the liquid at  $325^\circ\text{C}$  is in equilibrium both before cooling and after heating (and so has the same liquid entropy  $S_{\text{liquid}}$ ).

(a) Is the residual entropy, eqn 5.18, experimentally larger on heating or on cooling in Fig. 5.18? (Hint: Use the fact that the integrals under the curves,  $\int_0^{T_e} (dQ/dT) dT$  give the heat flow, which by conservation of energy must be the same on heating and cooling. The heating curve

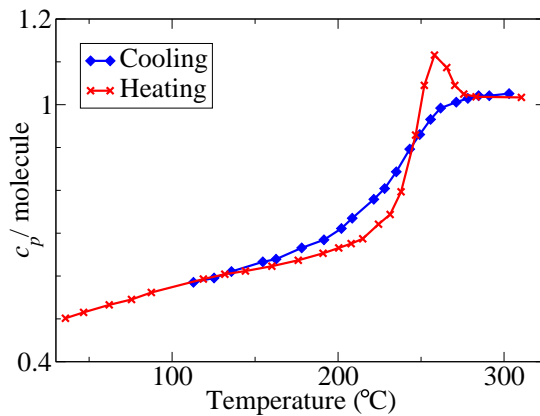
<sup>49</sup>We also study this map in Exercises 4.3, 5.16, and 12.9.

<sup>50</sup>The Poincaré section (Fig. 4.8) takes a continuous, recirculating dynamical system and replaces it with a once-return map, providing the standard motivation for treating maps and continuous evolution laws together. This motivation does not directly apply here, because the logistic map 4.12 is not invertible, so it is not directly given by a Poincaré section of a smooth differential equation. (Remember the existence and uniqueness theorems from math class? The invertibility follows from uniqueness.)

<sup>51</sup>Also, you may assume  $\partial^n \rho / \partial x^n \log \rho$  goes to zero at  $x = \pm\infty$ , even though  $\log \rho$  goes to  $-\infty$ .

in Fig. 5.18 shifts weight to higher temperatures; will that increase or decrease the integral  $\int (1/T)(dQ/dT) dT$ ?

(b) By using the second law (entropy can only increase), show that when cooling and then heating from an equilibrium liquid the residual entropy measured on cooling must always be less than the residual entropy measured on heating. Your argument should be completely general, applicable to any system out of equilibrium. (Hint: Consider the entropy flow into the outside world upon cooling the liquid into the glass, compared to the entropy flow from the outside world to heat the glass into the liquid again. The initial and final states of the liquid are both in equilibrium. See [77].)



**Fig. 5.18 Glass transition specific heat.** Specific heat of  $B_2O_3$  glass measured while heating and cooling [138]. The glass was first rapidly cooled from the melt ( $500^\circ C \rightarrow 50^\circ C$  in a half hour), then heated from  $33^\circ C \rightarrow 345^\circ C$  in 14 hours, cooled from  $345^\circ C$  to room temperature in 18 hours (diamonds), and finally heated from  $35^\circ C \rightarrow 325^\circ C$  (crosses). See [75].

The residual entropy of a typical glass is about  $k_B$  per molecular unit. It is a measure of how many different glassy configurations of atoms the material can freeze into.

(c) In a molecular dynamics simulation with one hundred indistinguishable atoms, and assuming that the residual entropy is  $k_B \log 2$  per atom, what is the probability that two coolings to zero energy will arrive at equivalent atomic configurations (up to permutations)? In a system with  $10^{23}$  molecular units, with residual entropy

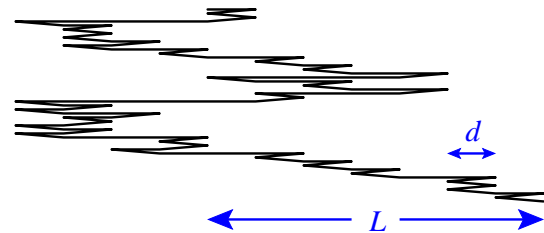
$k_B \log 2$  per unit, about how many coolings would be needed for one to duplicate the original configuration again, with probability  $1/2$ ?

(5.12) **Rubber band.** (Condensed matter) ②

Figure 5.19 shows a one-dimensional model for rubber. Rubber is formed from long polymeric molecules, which undergo random walks in the undeformed material. When we stretch the rubber, the molecules respond by rearranging their random walk to elongate in the direction of the external stretch. In our model, the molecule is represented by a set of  $N$  links of length  $d$ , which with equal energy point either parallel or antiparallel to the previous link. Let the total change in position to the right, from the beginning of the polymer to the end, be  $L$ .

As the molecule extent  $L$  increases, the entropy of our rubber molecule decreases.

(a) Find an exact formula for the entropy of this system in terms of  $d$ ,  $N$ , and  $L$ . (Hint: How many ways can one divide  $N$  links into  $M$  right-pointing links and  $N - M$  left-pointing links, so that the total length is  $L$ ?)



**Fig. 5.19 Rubber band.** Simple model of a rubber band with  $N = 100$  segments. The beginning of the polymer is at the top; the end is at the bottom; the vertical displacements are added for visualization.

The external world, in equilibrium at temperature  $T$ , exerts a force pulling the end of the molecule to the right. The molecule must exert an equal and opposite entropic force  $F$ .

(b) Find an expression for the force  $F$  exerted by the molecule on the bath in terms of the bath entropy. (Hint: The bath temperature  $1/T = \partial S_{\text{bath}}/\partial E$ , and force times distance is energy.) Using the fact that the length  $L$  must maximize the entropy of the Universe, write a general expression for  $F$  in terms of the internal entropy  $S$  of the molecule.

(c) Take our model of the molecule from part (a), the general law of part (b), and Stirling's formula

$\log(n!) \approx n \log n - n$ , write the force law  $F(L)$  for our molecule for large lengths  $N$ . What is the spring constant  $K$  in Hooke's law  $F = -KL$  for our molecule, for small  $L$ ?

Our model has no internal energy; this force is entirely entropic.

(d) *If we increase the temperature of our rubber band while it is under tension, will it expand or contract? Why?*

In a more realistic model of a rubber band, the entropy consists primarily of our configurational random-walk entropy plus a vibrational entropy of the molecules. If we stretch the rubber band without allowing heat to flow in or out of the rubber, the total entropy should stay approximately constant. (Rubber is designed to bounce well; little irreversible entropy is generated in a cycle of stretching and compression, so long as the deformation is not too abrupt.)

(e) *True or false?*

(T) (F) *When we stretch the rubber band, it will cool; the configurational entropy of the random walk will decrease, causing the entropy in the vibrations to decrease, causing the temperature to decrease.*

(T) (F) *When we stretch the rubber band, it will cool; the configurational entropy of the random walk will decrease, causing the entropy in the vibrations to increase, causing the temperature to decrease.*

(T) (F) *When we let the rubber band relax, it will cool; the configurational entropy of the random walk will increase, causing the entropy in the vibrations to decrease, causing the temperature to decrease.*

(T) (F) *When we let the rubber band relax, there must be no temperature change, since the entropy is constant.*

This more realistic model is much like the ideal gas, which also had no configurational energy.

(T) (F) *Like the ideal gas, the temperature changes because of the net work done on the system.*

(T) (F) *Unlike the ideal gas, the work done on the rubber band is positive when the rubber band expands.*

You should check your conclusions experimen-

tally; find a rubber band (thick and stretchy is best), touch it to your lips (which are very sensitive to temperature), and stretch and relax it.

(5.13) **How many shuffles?** (Mathematics) ③

How many shuffles does it take to randomize a deck of 52 cards?

The answer is a bit controversial; it depends on how one measures the information left in the cards. Some suggest that seven shuffles are needed; others say that six are enough.<sup>52</sup> We will follow reference [141], and measure the growing randomness using the information entropy.

We imagine the deck starts out in a known order (say,  $A\spadesuit, 2\spadesuit, \dots, K\clubsuit$ ).

(a) *What is the information entropy of the deck before it is shuffled? After it is completely randomized?*

The mathematical definition of a *riffle shuffle* is easiest to express if we look at it backward.<sup>53</sup>

Consider the deck after a riffle; each card in the deck either came from the upper half or the lower half of the original deck. A riffle shuffle makes each of the  $2^{52}$  choices (which card came from which half) equally likely.

(b) *Ignoring the possibility that two different riffles could yield the same final sequence of cards, what is the information entropy after one riffle?*

You can convince yourself that the only way two riffles can yield the same sequence is if all the cards in the bottom half are dropped first, followed by all the cards in the top half.

(c) *How many of the  $2^{52}$  possible riffles drop the entire bottom half and then the entire top half, leaving the card ordering unchanged? Hence, what is the actual information entropy after one riffle shuffle? (Hint: Calculate the shift from your answer for part (b).)*

We can put a lower bound on the number of riffles needed to destroy all information by assuming the entropy increase stays constant for future shuffles.

(d) *Continuing to ignore the possibility that two different sets of  $m$  riffles could yield the same final sequence of cards, how many riffles would it take for the entropy to pass that of a completely randomized deck?*

<sup>52</sup>More substantively, as the number of cards  $N \rightarrow \infty$ , some measures of information show an abrupt transition near  $\frac{3}{2} \log_2 N$ , while by other measures the information vanishes smoothly and most of it is gone by  $\log_2 N$  shuffles.

<sup>53</sup>In the forward definition of a riffle shuffle, one first cuts the deck into two 'halves', according to a binomial distribution: the probability that  $n$  cards are chosen for the top half is  $2^{-52} \binom{52}{n}$ . We then drop cards in sequence from the two halves into a pile, with the probability of a card being dropped proportional to the number of cards remaining in its half. You can check that this makes each of the  $2^{52}$  choices in the backward definition equally likely.

- (5.14) **Information entropy.** (Computer science, Mathematics, Complexity) ②

Entropy is a measure of your ignorance about a system; it is a measure of the lack of information. It has important implications in communication technologies: messages passed across a network communicate information, reducing the information entropy for the receiver.

Your grandparent has sent you an e-mail message. From the header of the message, you know it contains 1000 characters. You know each character is made of 8 bits, which allows  $2^8 = 256$  different letters or symbols per character.

(a) *Assuming all possible messages from your grandparent are equally likely (a typical message would then look like  $G^*me!18V[beep]...$ ), how many different messages  $N$  could there be? What is the corresponding upper bound  $S_{\max}$  for the information entropy  $k_S \log N$ ?*

Your grandparent writes rather dull messages; they all fall into the same pattern. They have a total of 16 equally likely messages.<sup>54</sup> After you read the message, you forget the details of the wording anyhow, and only remember these key points of information.

(b) *What is the actual information entropy change  $\Delta S_{\text{Shannon}}$  you undergo when reading the message? If your grandparent writes one message per month, what is the minimum number of 8-bit characters per year that it would take to send your grandparent's messages? (You may lump multiple messages into a single character.) (Hints:  $\Delta S_{\text{Shannon}}$  is your change in entropy from before you read the message to after you read which of 16 messages it was. The length of 1000 is *not* important for this part.)*

Remark: This is an extreme form of lossy data compression, like that used in jpeg images, mpeg animations, and mp3 audio files. We are asking for the number of characters per year for an optimally compressed signal.

- (5.15) **Shannon entropy.** (Computer science) ③

Natural languages are highly redundant; the number of intelligible fifty-letter English sentences is many fewer than  $26^{50}$ , and the number of distinguishable ten-second phone conversations is far smaller than the number of sound

signals that could be generated with frequencies up to 20 000 Hz.<sup>55</sup>

This immediately suggests a theory for signal compression. If you can recode the alphabet so that common letters and common sequences of letters are abbreviated, while infrequent combinations are spelled out in lengthy fashion, you can dramatically reduce the channel capacity needed to send the data. (This is lossless compression, like zip, gz, and gif.)

An obscure language A'bc! for long-distance communication has only three sounds: a hoot represented by A, a slap represented by B, and a click represented by C. In a typical message, hoots and slaps occur equally often ( $p = 1/4$ ), but clicks are twice as common ( $p = 1/2$ ). Assume the messages are otherwise random.

(a) *What is the Shannon entropy in this language? More specifically, what is the Shannon entropy rate  $-k_S \sum p_m \log p_m$ , the entropy per sound or letter transmitted?*

(b) *Show that a communication channel transmitting bits (ones and zeros) can transmit no more than one unit of Shannon entropy per bit. (Hint: This should follow by showing that, for  $N = 2^n$  messages, the Shannon entropy is maximized by  $p_m = 1/N$ . We have proved this already in a complicated way (note 36, p. 88); here prove it is a local extremum, either using a Lagrange multiplier or by explicitly setting  $p_N = 1 - \sum_{m=1}^{N-1} p_m$ .)*

(c) *In general, argue that the Shannon entropy gives the minimum number of bits needed to transmit the ensemble of messages. (Hint: Compare the Shannon entropy of the  $N$  original messages with the Shannon entropy of the  $N$  (shorter) encoded messages.) Calculate the minimum number of bits per letter on average needed to transmit messages for the particular case of an A'bc! communication channel.*

(d) *Find a compression scheme (a rule that converts a A'bc! message to zeros and ones, that can be inverted to give back the original message) that is optimal, in the sense that it saturates the bound you derived in part (b). (Hint: Look for a scheme for encoding the message that com-*

<sup>54</sup>Each message mentions whether they won their bridge hand last week (a fifty-fifty chance), mentions that they wish you would write more often (every time), and speculates who will win the women's college basketball tournament in their region (picking at random one of the eight teams in the league).

<sup>55</sup>Telephones, for example, do not span this whole frequency range: they are limited on the low end at 300–400 Hz, and on the high end at 3000–3500 Hz. You can still understand the words, so this crude form of data compression is only losing non-verbal nuances in the communication (Paul Ginsparg, private communication).



presses one letter at a time. Not all letters need to compress to the same number of bits.) Shannon also developed a measure of the channel capacity of a noisy wire, and discussed error-correction codes, etc.

(5.16) **Fractal dimensions.**<sup>56</sup> (Mathematics, Complexity) ④

There are many strange sets that emerge in science. In statistical mechanics, such sets often arise at continuous phase transitions, where self-similar spatial structures arise (Chapter 12). In chaotic dynamical systems, the attractor (the set of points occupied at long times after the transients have disappeared) is often a fractal (called a *strange attractor*). These sets are often tenuous and jagged, with holes on all length scales; see Figs 12.2, 12.5, and 12.11.

We often try to characterize these strange sets by a dimension. The dimensions of two extremely different sets can be the same; the path exhibited by a random walk (embedded in three or more dimensions) is arguably a two-dimensional set (note 6 on p. 17), but does not locally look like a surface. However, if two sets have different spatial dimensions (measured in the same way) they are certainly qualitatively different.

There is more than one way to define a dimension. Roughly speaking, strange sets are often spatially inhomogeneous, and what dimension you measure depends upon how you weight different regions of the set. In this exercise, we will calculate the *information dimension* (closely connected to the non-equilibrium entropy), and the *capacity dimension* (originally called the *Hausdorff dimension*, also sometimes called the *fractal dimension*).

To generate our strange set—along with some more ordinary sets—we will use the logistic map<sup>57</sup>

$$f(x) = 4\mu x(1 - x). \quad (5.42)$$

The attractor for the logistic map is a periodic orbit (dimension zero) at  $\mu = 0.8$ , and a chaotic, cusped density filling two intervals (dimension one)<sup>58</sup> at  $\mu = 0.9$ . At the onset of chaos at

$\mu = \mu_\infty \approx 0.892486418$  (Exercise 12.9) the dimension becomes intermediate between zero and one; this strange, self-similar set is called the *Feigenbaum attractor*.

Both the information dimension and the capacity dimension are defined in terms of the occupation  $P_n$  of cells of size  $\epsilon$  in the limit as  $\epsilon \rightarrow 0$ . (a) Write a routine which, given  $\mu$  and a set of bin sizes  $\epsilon$ , does the following.

- Iterates  $f$  hundreds or thousands of times (to get onto the attractor).
- Iterates  $f$  a large number  $N_{\text{tot}}$  more times, collecting points on the attractor. (For  $\mu \leq \mu_\infty$ , you could just integrate  $2^n$  times for  $n$  fairly large.)
- For each  $\epsilon$ , use a histogram to calculate the probability  $P_j$  that the points fall in the  $j$ th bin.
- Return the set of vectors  $P_j[\epsilon]$ .

You may wish to test your routine by using it for  $\mu = 1$  (where the distribution should look like  $\rho(x) = 1/\pi\sqrt{x(1-x)}$ , Exercise 4.3(b)) and  $\mu = 0.8$  (where the distribution should look like two  $\delta$ -functions, each with half of the points).

*The capacity dimension.* The definition of the capacity dimension is motivated by the idea that it takes at least

$$N_{\text{cover}} = V/\epsilon^D \quad (5.43)$$

bins of size  $\epsilon^D$  to cover a  $D$ -dimensional set of volume  $V$ .<sup>59</sup> By taking logs of both sides we find  $\log N_{\text{cover}} \approx \log V + D \log \epsilon$ . The capacity dimension is defined as the limit

$$D_{\text{capacity}} = \lim_{\epsilon \rightarrow 0} \frac{\log N_{\text{cover}}}{\log \epsilon}, \quad (5.44)$$

but the convergence is slow (the error goes roughly as  $\log V/\log \epsilon$ ). Faster convergence is given by calculating the slope of  $\log N$  versus  $\log \epsilon$ :

$$\begin{aligned} D_{\text{capacity}} &= \lim_{\epsilon \rightarrow 0} \frac{d \log N_{\text{cover}}}{d \log \epsilon} \\ &= \lim_{\epsilon \rightarrow 0} \frac{\log N_{j+1} - \log N_j}{\log \epsilon_{j+1} - \log \epsilon_j}. \end{aligned} \quad (5.45)$$

<sup>56</sup>This exercise and the associated software were developed in collaboration with Christopher Myers.

<sup>57</sup>We also study this map in Exercises 4.3, 5.9, and 12.9.

<sup>58</sup>See Exercise 4.3. The chaotic region for the logistic map does not have a strange attractor because the map is confined to one dimension; period-doubling cascades for dynamical systems in higher spatial dimensions have fractal, strange attractors in the chaotic region.

<sup>59</sup>Imagine covering the surface of a sphere in 3D with tiny cubes; the number of cubes will go as the surface area (2D volume) divided by  $\epsilon^2$ .

(b) Use your routine from part (a), write a routine to calculate  $N[\epsilon]$  by counting non-empty bins. Plot  $D_{\text{capacity}}$  from the fast convergence eqn 5.45 versus the midpoint  $\frac{1}{2}(\log \epsilon_{i+1} + \log \epsilon_i)$ . Does it appear to extrapolate to  $D = 1$  for  $\mu = 0.9$ ?<sup>60</sup> Does it appear to extrapolate to  $D = 0$  for  $\mu = 0.8$ ? Plot these two curves together with the curve for  $\mu_\infty$ . Does the last one appear to converge to  $D_1 \approx 0.538$ , the capacity dimension for the Feigenbaum attractor gleaned from the literature? How small a deviation from  $\mu_\infty$  does it take to see the numerical cross-over to integer dimensions?

Entropy and the information dimension. The probability density  $\rho(x_j) \approx P_j/\epsilon = (1/\epsilon)(N_j/N_{\text{tot}})$ . Converting the entropy formula 5.20 to a sum gives

$$\begin{aligned} S &= -k_B \int \rho(x) \log(\rho(x)) dx \\ &\approx - \sum_j \frac{P_j}{\epsilon} \log \left( \frac{P_j}{\epsilon} \right) \epsilon \\ &= - \sum_j P_j \log P_j + \log \epsilon \end{aligned} \quad (5.46)$$

(setting the conversion factor  $k_B = 1$  for convenience).

You might imagine that the entropy for a fixed-point would be zero, and the entropy for a period- $m$  cycle would be  $k_B \log m$ . But this is incorrect; when there is a fixed-point or a periodic limit cycle, the attractor is on a set of dimension zero (a bunch of points) rather than dimension one. The entropy must go to minus infinity—since we have precise information about where the trajectory sits at long times. To estimate the ‘zero-dimensional’ entropy  $k_B \log m$  on the computer, we would use the discrete form of the entropy (eqn 5.19), summing over bins  $P_j$  instead of integrating over  $x$ :

$$S_{d=0} = - \sum_j P_j \log(P_j) = S_{d=1} - \log(\epsilon). \quad (5.47)$$

More generally, the ‘natural’ measure of the entropy for a set with  $D$  dimensions might be defined as

$$S_D = - \sum_j P_j \log(P_j) + D \log(\epsilon). \quad (5.48)$$

Instead of using this formula to define the entropy, mathematicians use it to define the information dimension

$$D_{\text{inf}} = \lim_{\epsilon \rightarrow 0} \left( \sum P_j \log P_j \right) / \log(\epsilon). \quad (5.49)$$

The information dimension agrees with the ordinary dimension for sets that locally look like  $\mathbb{R}^D$ . It is different from the capacity dimension (eqn 5.44), which counts each occupied bin equally; the information dimension counts heavily occupied parts (bins) in the attractor more heavily. Again, we can speed up the convergence by noting that eqn 5.48 says that  $\sum_j P_j \log P_j$  is a linear function of  $\log \epsilon$  with slope  $D$  and intercept  $S_D$ . Measuring the slope directly, we find

$$D_{\text{inf}} = \lim_{\epsilon \rightarrow 0} \frac{d \sum_j P_j(\epsilon) \log P_j(\epsilon)}{d \log \epsilon}. \quad (5.50)$$

(c) As in part (b), write a routine that plots  $D_{\text{inf}}$  from eqn 5.50 as a function of the midpoint  $\log \epsilon$ , as we increase the number of bins. Plot the curves for  $\mu = 0.9$ ,  $\mu = 0.8$ , and  $\mu_\infty$ . Does the information dimension agree with the ordinary one for the first two? Does the last one appear to converge to  $D_1 \approx 0.517098$ , the information dimension for the Feigenbaum attractor from the literature?

Most ‘real world’ fractals have a whole spectrum of different characteristic spatial dimensions; they are *multifractal*.

(5.17) **Deriving entropy.** (Mathematics) ③

In this exercise, you will show that there is a unique continuous function  $S_I$  (up to the constant  $k_B$ ) satisfying the three key properties (eqns 5.25, 5.29, and 5.35) for a good measure of ignorance:

$$S_I \left( \frac{1}{\Omega}, \dots, \frac{1}{\Omega} \right) > S_I(p_1, \dots, p_\Omega) \quad (5.51)$$

unless  $p_i = 1/\Omega$  for all  $i$ ,

$$S_I(p_1, \dots, p_{\Omega-1}, 0) = S_I(p_1, \dots, p_{\Omega-1}), \quad (5.52)$$

and

$$\langle S_I(A|B_\ell) \rangle_B = S_I(AB) - S_I(B). \quad (5.53)$$

<sup>60</sup>In the chaotic regions, keep the number of bins small compared to the number of iterates in your sample, or you will start finding empty bins between points and eventually get a dimension of zero.

Here

$$\begin{aligned}
 S_I(A) &= S_I(p_1, \dots, p_\Omega), \\
 S_I(B) &= S_I(q_1, \dots, q_M), \\
 \langle S_I(A|B_\ell) \rangle_B &= \sum_\ell q_\ell S_I(c_{1\ell}, \dots, c_{\Omega\ell}), \\
 S_I(AB) &= S_I(c_{11}q_1, \dots, c_{\Omega M}q_M).
 \end{aligned}$$

You will show, naturally, that this function is our non-equilibrium entropy 5.19. The presentation is based on the proof in the excellent small book by Khinchin [66].

For convenience, define  $L(g) = S_I(1/g, \dots, 1/g)$ .

(a) For any rational probabilities  $q_\ell$ , let  $g$  be the least common multiple of their denominators, and let  $q_\ell = g_\ell/g$  for integers  $g_\ell$ . Show that

$$S_I(B) = L(g) - \sum_\ell q_\ell L(g_\ell). \quad (5.54)$$

(Hint: Consider  $AB$  to have  $g$  possibilities of probability  $1/g$ ,  $B$  to measure which group of size  $g_\ell$ , and  $A$  to measure which of the  $g_\ell$  members of group  $\ell$ , see Fig. 5.20.)

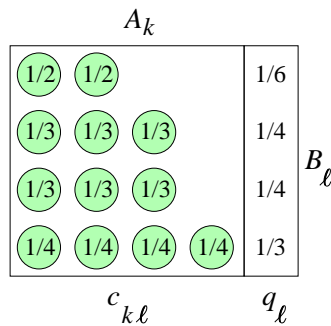


Fig. 5.20 Rational probabilities and conditional entropy. Here the probabilities  $q_\ell =$

$(1/6, 1/3, 1/3, 1/2)$  of state  $B_\ell$  are rational. We can split the total probability into  $g = 12$  equal pieces (circles, each probability  $r_{k\ell} = 1/12$ ), with  $g_k = (2, 3, 3, 4)$  pieces for the corresponding measurement  $B_\ell$ . We can then write our ignorance  $S_I(B)$  in terms of the (maximal) equal-likelihood ignorances  $L(g) = S_I(1/g, \dots)$  and  $L(g_k)$ , and use the entropy change for conditional probabilities property (eqn 5.35) to derive our ignorance  $S_I(B)$  (eqn 5.54).

(b) If  $L(g) = k_S \log g$ , show that eqn 5.54 is the Shannon entropy 5.23.

Knowing that  $S_I(A)$  is the Shannon entropy for all rational probabilities, and assuming that  $S_I(A)$  is continuous, makes  $S_I(A)$  the Shannon entropy. So, we have reduced the problem to showing  $L(g)$  is the logarithm up to a constant.

(c) Show that  $L(g)$  is monotone increasing with  $g$ . (Hint: You will need to use both of the first two key properties.)

(d) Show  $L(g^n) = nL(g)$ . (Hint: Consider  $n$  independent probability distributions each of  $g$  equally-likely events. Use the third property recursively on  $n$ .)

(e) If  $2^m < s^n < 2^{m+1}$ , using the results of parts (c) and (d) show

$$\frac{m}{n} < \frac{L(s)}{L(2)} < \frac{m+1}{n}. \quad (5.55)$$

(Hint: How is  $L(2^m)$  related to  $L(s^n)$  and  $L(2^{m+1})$ ?) Show also using the same argument that  $m/n < \log(s)/\log(2) < (m+1)/n$ . Hence, show that  $|L(s)/L(2) - \log(s)/\log(2)| < 1/n$  and thus  $L(s) = k \log s$  for some constant  $k$ .

Hence our ignorance function  $S_I$  agrees with the formula for the non-equilibrium entropy uniquely (up to an overall constant).



# Free energies



In this chapter, we explain how to study *parts* of statistical mechanical systems. If we ignore most of our system—agreeing not to ask questions about certain degrees of freedom—the statistical mechanical predictions about the remaining parts of our system are embodied in a new statistical ensemble and its associated *free energy*. These free energies usually make calculations easier and the physical behavior more comprehensible. What do we ignore?

*We ignore the external world.* Most systems are not isolated; they often can exchange energy, volume, or particles with an outside world in equilibrium (often called the *heat bath*). If the coupling to the external world is weak, we can remove it from consideration. The constant-temperature *canonical*<sup>1</sup> ensemble (Section 6.1) and the *Helmholtz* free energy arise from a bath which can exchange energy; the *grand canonical* ensemble (Section 6.3) and the grand free energy arise from baths which also exchange particles at fixed chemical potential. For large systems, these different ensembles predict the same average behavior (apart from tiny fluctuations); we could in principle do most calculations of interest at constant energy and particle number. However, calculations using the appropriate free energy can be much simpler (Section 6.2).

*We ignore unimportant internal degrees of freedom.* In studying (say) chemical reactions, magnets, or the motion of large mechanical objects, one is normally not interested in the motions of the individual atoms. To ignore them in mechanical systems, one introduces *friction* and *noise* (Section 6.5). By ignoring the atomic motions in chemical reactions, one derives reaction rate theory (Section 6.6).

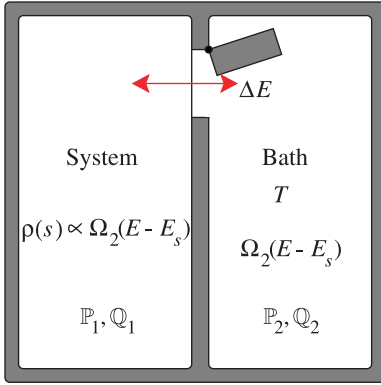
*We coarse grain.* Many systems are not homogeneous, because of initial conditions or boundary conditions; their properties vary in space and/or time. If these systems are locally near equilibrium, we can ignore the internal degrees of freedom in small volumes, *coarse-graining* our description by keeping only the continuum fields which describe the local state.<sup>2</sup> As an example, in Section 6.7 we will calculate the free energy density for the ideal gas, and use it to (again) derive the diffusion equation.

We will calculate free energies explicitly in several important cases in this chapter. Note that free energies are important tools, however, even for systems too complex to solve analytically. We provide these solvable examples in part to motivate later continuum derivations of free energies for systems where microscopic calculations are not feasible.

6.1	The canonical ensemble	106
6.2	Uncoupled systems and canonical ensembles	109
6.3	Grand canonical ensemble	112
6.4	What is thermodynamics?	113
6.5	Mechanics: friction and fluctuations	117
6.6	Chemical equilibrium and reaction rates	118
6.7	Free energy density for the ideal gas	121

<sup>1</sup>**Canonical** (*Oxford English dictionary*): ...4. *gen.* Of the nature of a canon or rule: of admitted authority, excellence, or supremacy; authoritative; orthodox; accepted; standard. 5. *Math.* Furnishing, or according to, a general rule or formula.

<sup>2</sup>These are the *order parameter fields* that we will study in Chapter 9.



**Fig. 6.1 The canonical ensemble** describes equilibrium systems which can exchange energy with a heat bath. The bath is at temperature  $T$ . The probability of a state  $s$  of the system with energy  $E_s$  is  $\rho(s) = \exp(-E_s/k_B T)/Z$ . The thermodynamics of the canonical ensemble is embodied in the Helmholtz free energy  $A(T, V, N) = E - TS$ .

## 6.1 The canonical ensemble

The canonical ensemble governs the equilibrium behavior of a system at fixed temperature. We defined the temperature in Section 3.3 by considering a total system comprised of two weakly-coupled parts, with phase-space coordinates  $(\mathbb{P}_1, \mathbb{Q}_1)$  and  $(\mathbb{P}_2, \mathbb{Q}_2)$  that can exchange energy. We will now focus on the first of these two parts (the *system*); the second part (the *heat bath*) we will assume to be large. We are not interested in measuring any properties that depend upon the heat bath, and want a statistical ensemble for the system that averages over the relevant states of the bath.

How does the probability that our system is in a state  $s$  depend upon its energy  $E_s$ ? As we discussed in Section 3.3, the probability density that our system will be in the particular state  $s$  is proportional to the volume of the energy shell for our heat bath at bath energy  $E - E_s$ :

$$\rho(s) \propto \Omega_2(E - E_s) = \exp(S_2(E - E_s)/k_B) \quad (6.1)$$

since a state  $s$  gets a share of the microcanonical probability for each heat-bath partner it can coexist with at the fixed total energy  $E$ .

Let us compare the probability of two typical states  $A$  and  $B$  of our equilibrium system. We know that the energy fluctuations are small, and we assume that the heat bath is large. We can therefore assume that the inverse temperature  $1/T_2 = \partial S_2/\partial E_2$  of the heat bath is constant in the range  $(E - E_A, E - E_B)$ . Hence,

$$\begin{aligned} \rho(s_B)/\rho(s_A) &= \Omega_2(E - E_B)/\Omega_2(E - E_A) \\ &= e^{(S_2(E - E_B) - S_2(E - E_A))/k_B} = e^{(E_A - E_B)(\partial S_2/\partial E)/k_B} \\ &= e^{(E_A - E_B)/k_B T_2}. \end{aligned} \quad (6.2)$$

This is the general derivation of the Boltzmann distribution; the probability of a particular system state<sup>3</sup> of energy  $E_s$  is

$$\rho(s) \propto \exp(-E_s/k_B T). \quad (6.3)$$

We know that the probability is normalized, so

$$\begin{aligned} \rho(s) &= \exp(-E_s/k_B T) / \int \frac{d\mathbb{P}_1 d\mathbb{Q}_1}{h^{3N_1}} \exp(-\mathcal{H}_1(\mathbb{P}_1, \mathbb{Q}_1)/k_B T) \\ &= \exp(-E_s/k_B T) / \sum_n \exp(-E_n/k_B T) \\ &= \exp(-E_s/k_B T)/Z, \end{aligned} \quad (6.4)$$

where the normalization factor

$$Z(T, N, V) = \sum_n \exp(-E_n/k_B T) = \int \frac{d\mathbb{P}_1 d\mathbb{Q}_1}{h^{3N_1}} \exp(-\mathcal{H}_1(\mathbb{P}_1, \mathbb{Q}_1)/k_B T) \quad (6.5)$$

is the *partition function*.<sup>4</sup>

<sup>3</sup>For a classical system, this is instead the probability per phase-space volume  $h^{3N}$ .

<sup>4</sup>To avoid blinding ourselves with integrals, we will write them as a ‘continuous sum’;  $\int d\mathbb{P} d\mathbb{Q}/h^{3N} \rightarrow \sum_n$  for the rest of this chapter. This notation foreshadows quantum mechanics (Chapter 7), where for bound systems the energy levels are discrete; it will also be appropriate for lattice systems like the Ising model (Section 8.1), where we have integrated away all the continuous degrees of freedom. No complications arise from translating the sums for the equations in this chapter back into integrals over phase space.

Equation 6.4 is the definition of the canonical ensemble,<sup>5</sup> appropriate for calculating properties of systems which can exchange energy with an external world at temperature  $T$ .

The partition function  $Z$  is just the normalization factor that keeps the total probability summing to one. It may surprise you to discover that this normalization factor plays a central role in the theory. Indeed, most quantities of interest can be calculated in two different ways: as an explicit sum over states or in terms of derivatives of the partition function. Let us see how this works by using  $Z$  to calculate the mean energy, the specific heat, and the entropy of a general system.

**Internal energy.** To calculate the average internal energy of our system<sup>6</sup>  $\langle E \rangle$ , we weight each state by its probability. Writing  $\beta = 1/(k_B T)$ ,

$$\begin{aligned} \langle E \rangle &= \sum_n E_n P_n = \frac{\sum_n E_n e^{-\beta E_n}}{Z} = -\frac{\partial Z / \partial \beta}{Z} \\ &= -\partial \log Z / \partial \beta. \end{aligned} \quad (6.11)$$

<sup>6</sup>The angle brackets represent canonical averages.

**Specific heat.** Let  $c_v$  be the specific heat per particle at constant volume. (The specific heat is the energy needed to increase the temperature by one unit,  $\partial \langle E \rangle / \partial T$ .) Using eqn 6.11, we get

$$N c_v = \frac{\partial \langle E \rangle}{\partial T} = \frac{\partial \langle E \rangle}{\partial \beta} \frac{d\beta}{dT} = -\frac{1}{k_B T^2} \frac{\partial \langle E \rangle}{\partial \beta} = \frac{1}{k_B T^2} \frac{\partial^2 \log Z}{\partial \beta^2}. \quad (6.12)$$

<sup>5</sup>A formal method of deriving the canonical ensemble is as a *partial trace*, removing the bath degrees of freedom from a microcanonical ensemble. To calculate the expectation of an operator  $B$  that depends only on system coordinates  $(\mathbb{P}_1, \mathbb{Q}_1)$ , we start by averaging over the energy shell in the entire space (eqn 3.5), including both the system coordinates and the bath coordinates  $(\mathbb{P}_2, \mathbb{Q}_2)$ :

$$\Omega(E) = \frac{1}{\delta E} \int_{E < \mathcal{H}_1 + \mathcal{H}_2 < E + \delta E} d\mathbb{P}_1 d\mathbb{Q}_1 d\mathbb{P}_2 d\mathbb{Q}_2 = \int dE_1 \Omega_1(E_1) \Omega_2(E - E_1). \quad (6.6)$$

$$\langle B \rangle = \frac{1}{\Omega(E) \delta E} \int_{E < \mathcal{H}_1 + \mathcal{H}_2 < E + \delta E} d\mathbb{P}_1 d\mathbb{Q}_1 B(\mathbb{P}_1, \mathbb{Q}_1) d\mathbb{P}_2 d\mathbb{Q}_2 = \frac{1}{\Omega(E)} \int d\mathbb{P}_1 d\mathbb{Q}_1 B(\mathbb{P}_1, \mathbb{Q}_1) \Omega_2(E - \mathcal{H}_1(\mathbb{P}_1, \mathbb{Q}_1)). \quad (6.7)$$

(The indistinguishability factors and Planck's constants in eqn 3.54 complicate the discussion here in inessential ways.) Again, if the heat bath is large the small variations  $E_1 - \langle E_1 \rangle$  will not change its temperature.  $1/T_2 = \partial S_2 / \partial E_2$  being fixed implies  $\partial \Omega_2(E - E_1) / \partial E_1 = -(1/k_B T) \Omega_2$ ; solving this differential equation gives

$$\Omega_2(E - E_1) = \Omega_2(E - \langle E_1 \rangle) \exp(-(E_1 - \langle E_1 \rangle) / k_B T). \quad (6.8)$$

This gives us

$$\begin{aligned} \Omega(E) &= \int dE_1 \Omega_1(E_1) \Omega_2(E - \langle E_1 \rangle) e^{-(E_1 - \langle E_1 \rangle) / k_B T} = \Omega_2(E - \langle E_1 \rangle) e^{\langle E_1 \rangle / k_B T} \int dE_1 \Omega_1(E_1) e^{-E_1 / k_B T} \\ &= \Omega_2(E - \langle E_1 \rangle) e^{\langle E_1 \rangle / k_B T} Z \end{aligned} \quad (6.9)$$

and

$$\langle B \rangle = \frac{\int d\mathbb{P}_1 d\mathbb{Q}_1 B(\mathbb{P}_1, \mathbb{Q}_1) \Omega_2(E - \langle E_1 \rangle) e^{-(\mathcal{H}_1(\mathbb{P}_1, \mathbb{Q}_1) - \langle E_1 \rangle) / k_B T}}{\Omega_2(E - \langle E_1 \rangle) e^{\langle E_1 \rangle / k_B T} Z} = \frac{1}{Z} \int d\mathbb{P}_1 d\mathbb{Q}_1 B(\mathbb{P}_1, \mathbb{Q}_1) \exp(-\mathcal{H}_1(\mathbb{P}_1, \mathbb{Q}_1) / k_B T). \quad (6.10)$$

By explicitly doing the integrals over  $\mathbb{P}_2$  and  $\mathbb{Q}_2$ , we have turned a microcanonical calculation into the canonical ensemble (eqn 6.4). Our calculation of the momentum distribution  $\rho(p_1)$  in Section 3.2.2 was precisely of this form; we integrated out all the other degrees of freedom, and were left with a Boltzmann distribution for the  $x$ -momentum of particle number one. This process is called *integrating out* the degrees of freedom for the heat bath, and is the general way of creating free energies.

We can expand the penultimate form of this formula into a sum, finding the intriguing result

$$\begin{aligned} Nc_v &= -\frac{1}{k_B T^2} \frac{\partial \langle E \rangle}{\partial \beta} = -\frac{1}{k_B T^2} \frac{\partial}{\partial \beta} \frac{\sum E_n e^{-\beta E_n}}{\sum e^{-\beta E_n}} \\ &= -\frac{1}{k_B T^2} \left[ \frac{(\sum E_n e^{-\beta E_n})^2}{Z^2} + \frac{\sum -E_n^2 e^{-\beta E_n}}{Z} \right] \\ &= \frac{1}{k_B T^2} [\langle E^2 \rangle - \langle E \rangle^2] = \frac{\sigma_E^2}{k_B T^2}, \end{aligned} \quad (6.13)$$

<sup>7</sup>We have used the standard trick  $\sigma_E^2 = \langle (E - \langle E \rangle)^2 \rangle = \langle E^2 \rangle - 2\langle E \rangle \langle E \rangle + \langle E \rangle^2 = \langle E^2 \rangle - \langle E \rangle^2$ , since  $\langle E \rangle$  is just a constant that can be pulled out of the ensemble average.

<sup>8</sup>We will properly introduce susceptibilities (linear responses) and other remarkable relations in Chapter 10.

<sup>9</sup>Alternatively, we could use the microcanonical definition of the entropy of the entire system and eqn 6.8 to show

$$\begin{aligned} S &= k_B \log \int dE_1 \Omega_1(E_1) \Omega_2(E - E_1) \\ &= k_B \log \int dE_1 \Omega_1(E_1) \Omega_2(E - \langle E_1 \rangle) \\ &\quad \exp(-(E_1 - \langle E_1 \rangle)/k_B T) \\ &= k_B \log \Omega_2(E - \langle E_1 \rangle) \\ &\quad + k_B \log (\exp(\langle E_1 \rangle/k_B T)) \\ &\quad + k_B \log \int dE_1 \Omega_1(E_1) \\ &\quad \exp(-E_1/k_B T) \\ &= k_B \log \Omega_2(E_2) \\ &\quad + k_B \beta \langle E_1 \rangle + k_B \log Z_1 \\ &= S_2 + \langle E_1 \rangle/T - A_1/T, \end{aligned}$$

so

$$\begin{aligned} S_1 &= \langle E_1 \rangle/T + k_B \log Z_1 \\ &= \langle E_1 \rangle/T - A_1/T, \end{aligned} \quad (6.15)$$

avoiding the use of the non-equilibrium entropy to derive the same result.

<sup>10</sup>Historically, thermodynamics and the various free energies came before statistical mechanics.

where  $\sigma_E$  is the root-mean-square fluctuation<sup>7</sup> in the energy of our system at constant temperature. Equation 6.13 is remarkable;<sup>8</sup> it is a relationship between a macroscopic susceptibility ( $c_v$ , the energy changes when the temperature is perturbed) and a microscopic fluctuation ( $\sigma_E$ , the energy fluctuation in thermal equilibrium). In general, fluctuations can be related to responses in this fashion. These relations are extremely useful, for example, in extracting susceptibilities from numerical simulations. For example, to measure the specific heat there is no need to make small changes in the temperature and measure the heat flow; just watch the energy fluctuations in equilibrium (Exercises 3.8 and 8.1).

Are results calculated using the canonical ensemble the same as those computed from our original microcanonical ensemble? Equation 6.13 tells us that the energy fluctuations per particle

$$\sigma_E/N = \sqrt{\langle E^2 \rangle - \langle E \rangle^2}/N = \sqrt{(k_B T)(c_v T)}/\sqrt{N}. \quad (6.14)$$

are tiny; they are  $1/\sqrt{N}$  times the geometric mean of two microscopic energies:  $k_B T$  (two-thirds the kinetic energy per particle) and  $c_v T$  (the energy per particle to heat from absolute zero, if the specific heat were temperature independent). These tiny fluctuations will not change the properties of a macroscopic system; the constant energy (microcanonical) and constant temperature (canonical) ensembles predict the same behavior.

**Entropy.** Using the general statistical mechanical formula<sup>9</sup> for the entropy 5.20, we find

$$\begin{aligned} S &= -k_B \sum P_n \log P_n = -k_B \sum \frac{\exp(-\beta E_n)}{Z} \log \left( \frac{\exp(-\beta E_n)}{Z} \right) \\ &= -k_B \frac{\sum \exp(-\beta E_n) (-\beta E_n - \log Z)}{Z} \\ &= k_B \beta \langle E \rangle + k_B \log Z \frac{\sum \exp(-\beta E_n)}{Z} = \frac{\langle E \rangle}{T} + k_B \log Z. \end{aligned} \quad (6.16)$$

Notice that the formulæ for  $\langle E \rangle$ ,  $c_v$ , and  $S$  all involve  $\log Z$  and its derivatives. This motivates us<sup>10</sup> to define a *free energy* for the canonical ensemble, called the *Helmholtz free energy*:

$$A(T, V, N) = -k_B T \log Z = \langle E \rangle - TS. \quad (6.17)$$



The entropy is minus the derivative of  $A$  with respect to  $T$ . Explicitly,

$$\begin{aligned} \left. \frac{\partial A}{\partial T} \right|_{N,V} &= -\frac{\partial k_B T \log Z}{\partial T} = -k_B \log Z - k_B T \frac{\partial \log Z}{\partial \beta} \frac{\partial \beta}{\partial T} \\ &= -k_B \log Z - k_B T \langle E \rangle / (k_B T^2) = -k_B \log Z - \langle E \rangle / T \\ &= -S. \end{aligned} \quad (6.18)$$

Why is it called a free energy? First,  $k_B T$  gives it the dimensions of an energy. Second, it is the energy available (free) to do work. A heat engine drawing energy  $E = Q_1$  from a hot bath that must discharge an entropy  $S = Q_2/T_2$  into a cold bath can do work  $W = Q_1 - Q_2 = E - T_2 S$ ;  $A = E - TS$  is the energy free to do useful work (Section 5.1).

We see that  $\exp(-A(T, V, N)/k_B T) = Z$ , quite analogous to the Boltzmann weight  $\exp(-E_s/k_B T)$ . The former is the phase-space volume or weight contributed by all states of a given  $N$  and  $V$ ; the latter is the weight associated with a particular state  $s$ . In general, free energies  $F(\mathbb{X})$  will remove all degrees of freedom except for certain constraints  $\mathbb{X}$ . The phase-space volume consistent with the constraints  $\mathbb{X}$  is  $\exp(-F(\mathbb{X})/k_B T)$ .

## 6.2 Uncoupled systems and canonical ensembles

The canonical ensemble is typically much more convenient for doing calculations because, for systems in which the Hamiltonian splits into uncoupled components, the partition function factors into pieces that can be computed separately. Let us show this.

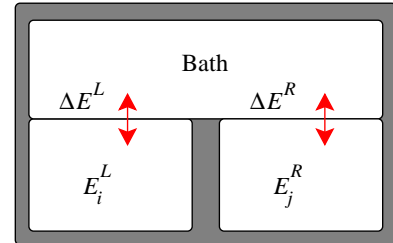
Suppose we have a system with two weakly-interacting subsystems  $L$  and  $R$ , both connected to a heat bath at  $\beta = 1/k_B T$ . The states for the whole system are pairs of states  $(s_i^L, s_j^R)$  from the two subsystems, with energies  $E_i^L$  and  $E_j^R$ , respectively. The partition function for the whole system is

$$\begin{aligned} Z &= \sum_{ij} \exp(-\beta(E_i^L + E_j^R)) = \sum_{ij} e^{-\beta E_i^L} e^{-\beta E_j^R} \\ &= \left( \sum_i e^{-\beta E_i^L} \right) \left( \sum_j e^{-\beta E_j^R} \right) \\ &= Z^L Z^R. \end{aligned} \quad (6.19)$$

Thus partition functions factor for uncoupled subsystems. The Helmholtz free energy therefore adds

$$A = -k_B T \log Z = -k_B T \log(Z^L \cdot Z^R) = A^L + A^R, \quad (6.20)$$

as does the entropy, average energy, and other *extensive* properties that one expects to scale with the size of the system.



**Fig. 6.2** Uncoupled systems attached to a common heat bath. Calculating the properties of two weakly-coupled subsystems is easier in the canonical ensemble than in the microcanonical ensemble. This is because energy in one subsystem can be exchanged with the bath, and does not affect the energy of the other subsystem.

This is much simpler than the same calculation would be in the microcanonical ensemble! In a microcanonical ensemble, each subsystem would compete with the other for the available total energy. Even though two subsystems are uncoupled (the energy of one is independent of the state of the other) the microcanonical ensemble intermingles them in the calculation. By allowing each to draw energy from a large heat bath, the canonical ensemble allows uncoupled subsystems to become independent calculations.

We can now immediately solve several important examples of uncoupled systems.

**Ideal gas.** The different atoms in an ideal gas are uncoupled. The partition function for  $N$  distinguishable ideal gas atoms of mass  $m$  in a cube of volume  $V = L^3$  factors into a product over each degree of freedom  $\alpha$ :

$$\begin{aligned} Z_{\text{ideal}}^{\text{dist}} &= \prod_{\alpha=1}^{3N} \frac{1}{h} \int_0^L dq_{\alpha} \int_{-\infty}^{\infty} dp_{\alpha} e^{-\beta p_{\alpha}^2/2m_{\alpha}} = \left( \frac{L}{h} \sqrt{\frac{2\pi m}{\beta}} \right)^{3N} \\ &= (L\sqrt{2\pi m k_B T/h^2})^{3N} = (L/\lambda)^{3N}. \end{aligned}$$

Here

$$\lambda = h/\sqrt{2\pi m k_B T} = \sqrt{2\pi \hbar^2/mk_B T} \quad (6.21)$$

is again the thermal de Broglie wavelength (eqn 3.59).

The mean internal energy in the ideal gas is

$$\langle E \rangle = -\frac{\partial \log Z_{\text{ideal}}}{\partial \beta} = -\frac{\partial}{\partial \beta} \log(\beta^{-3N/2}) = \frac{3N}{2\beta} = \frac{3}{2} N k_B T, \quad (6.22)$$

giving us the equipartition theorem for momentum without our needing to find volumes of spheres in  $3N$  dimensions (Section 3.2.2).

For  $N$  undistinguished particles, we have counted each real configuration  $N!$  times for the different permutations of particles, so we must divide  $Z_{\text{ideal}}^{\text{dist}}$  by  $N!$  just as we did for the phase-space volume  $\Omega$  in Section 3.5:

$$Z_{\text{ideal}}^{\text{indist}} = (L/\lambda)^{3N}/N!. \quad (6.23)$$

This does not change the internal energy, but does affect the Helmholtz free energy:

$$\begin{aligned} A_{\text{ideal}}^{\text{indist}} &= -k_B T \log((L/\lambda)^{3N}/N!) \\ &= -N k_B T \log(V/\lambda^3) + k_B T \log(N!) \\ &\sim -N k_B T \log(V/\lambda^3) + k_B T (N \log N - N) \\ &= -N k_B T (\log(V/N\lambda^3) + 1) \\ &= N k_B T (\log(\rho\lambda^3) - 1), \end{aligned} \quad (6.24)$$

where  $\rho = N/V$  is the average density, and we have used Stirling's formula  $\log(N!) \sim N \log N - N$ .

Finally, the entropy of  $N$  undistinguished particles, in the canonical ensemble, is

$$\begin{aligned} S &= -\frac{\partial A}{\partial T} = -Nk_B (\log(\rho\lambda^3) - 1) - Nk_B T \frac{\partial \log T^{-3/2}}{\partial T} \\ &= Nk_B (5/2 - \log(\rho\lambda^3)), \end{aligned} \quad (6.25)$$

as we derived (with much more effort) using the microcanonical ensemble (eqn 3.58).

**Classical harmonic oscillator.** Electromagnetic radiation, the vibrations of atoms in solids, and the excitations of many other systems near their equilibria can be approximately described as a set of uncoupled harmonic oscillators.<sup>11</sup> Using the canonical ensemble, the statistical mechanics of these systems thus decomposes into a calculation for each mode separately.

A harmonic oscillator of mass  $m$  and frequency  $\omega$  has a total energy

$$\mathcal{H}(p, q) = p^2/2m + m\omega^2 q^2/2. \quad (6.29)$$

The partition function for one such oscillator is (using  $\hbar = h/2\pi$ )

$$\begin{aligned} Z &= \int_{-\infty}^{\infty} dq \int_{-\infty}^{\infty} dp \frac{1}{h} e^{-\beta(p^2/2m + m\omega^2 q^2/2)} = \frac{1}{h} \sqrt{\frac{2\pi}{\beta m \omega^2}} \sqrt{\frac{2\pi m}{\beta}} \\ &= \frac{1}{\beta \hbar \omega}. \end{aligned} \quad (6.30)$$

Hence the Helmholtz free energy for the classical oscillator is

$$A_\omega(T) = -k_B T \log Z = k_B T \log(\hbar \omega / k_B T), \quad (6.31)$$

the internal energy is

$$\langle E \rangle_\omega(T) = -\frac{\partial \log Z}{\partial \beta} = \frac{\partial}{\partial \beta} (\log \beta + \log \hbar \omega) = 1/\beta = k_B T, \quad (6.32)$$

and hence  $c_v = \partial \langle E \rangle / \partial T = k_B$ . This is the general statement of the equipartition theorem:<sup>12</sup> each harmonic degree of freedom ( $p$  and  $q$  count as two) in a classical equilibrium system has mean energy  $\frac{1}{2}k_B T$ .

**Classical velocity distributions.** One will notice both for the ideal gas and for the harmonic oscillator that each component of the momentum contributed a factor  $\sqrt{2\pi m/\beta}$  to the partition function. As we promised in Section 3.2.2, this will happen in any classical system where the momenta are uncoupled to the positions; that is, where the momentum parts of the energy are of the standard form  $\sum_\alpha p_\alpha^2/2m_\alpha$  (non-quantum, non-relativistic, non-magnetic particles). In these systems the velocity distribution is always Maxwellian (eqn 1.2), independent of what configuration the positions have.

This is a powerful, counterintuitive truth. The equilibrium velocity distribution of atoms crossing barriers in chemical reactions (Section 6.6) or surrounding mountain tops is the same as those in the low-energy valleys.<sup>13</sup> Each atom does slow down as it climbs, but only the formerly energetic ones make it to the top. The population density at the top is thus smaller, but the kinetic energy distribution remains the same (Exercise 6.1).

<sup>11</sup>For example, at temperatures low compared to the melting point a solid or molecule with an arbitrary many-body interaction potential  $\mathcal{V}(\mathbb{Q})$  typically only makes small excursions about the minimum  $\mathbb{Q}_0$  of the potential. We expand about this minimum, giving us

$$\begin{aligned} \mathcal{V}(\mathbb{Q}) &\approx \mathcal{V}(\mathbb{Q}_0) + \sum_\alpha (\mathbb{Q} - \mathbb{Q}_0)_\alpha \partial_\alpha \mathcal{V} \\ &+ \sum_{\alpha, \beta} \frac{1}{2} (\mathbb{Q} - \mathbb{Q}_0)_\alpha (\mathbb{Q} - \mathbb{Q}_0)_\beta \\ &\quad \times \partial_\alpha \partial_\beta \mathcal{V} + \dots \end{aligned} \quad (6.26)$$

Since the potential is a minimum at  $\mathbb{Q}_0$ , the gradient of the potential must be zero, so second term on the right-hand side must vanish. The third term is a large  $3N \times 3N$  quadratic form, which we may diagonalize by converting to *normal modes*  $q_k$ . (If the masses of the atoms are not all the same, one must rescale the components of  $\mathbb{Q} - \mathbb{Q}_0$  by the square root of the corresponding mass before diagonalizing.) In terms of these normal modes, the Hamiltonian is a set of uncoupled harmonic oscillators:

$$\mathcal{H} = \sum_k p_k^2/2m + m\omega_k^2 q_k^2/2. \quad (6.27)$$

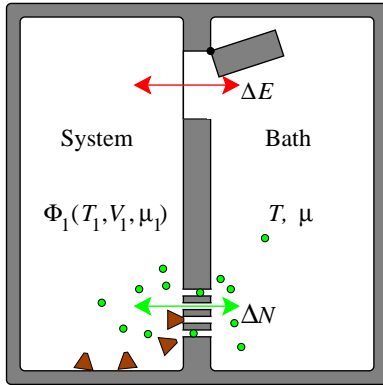
At high enough temperatures that quantum mechanics can be ignored, we can then use eqn 6.30 to find the total partition function for our harmonic system

$$Z = \prod_k Z_k = \prod_k (1/\beta \hbar \omega_k). \quad (6.28)$$

(In Section 7.2 we will consider the quantum harmonic oscillator, which often gives an accurate theory for atomic vibrations at all temperatures up to the melting point.)

<sup>12</sup>We saw the theorem for  $p$  in Section 3.2.2.

<sup>13</sup>Mountain tops would not be colder if the atmosphere were in equilibrium.



**Fig. 6.3 The grand canonical ensemble** describes equilibrium systems which can exchange energy and particles with a heat bath. The probability of a state  $s$  of the system with  $N_s$  particles and energy  $E_s$  is  $\rho(s) = \exp(-(E_s - \mu N_s)/(k_B T))/Z$ . The thermodynamics of the grand canonical ensemble is embodied in the grand free energy  $\Phi(T, V, \mu)$ .

### 6.3 Grand canonical ensemble

The grand canonical ensemble allows one to decouple the calculations of systems which can exchange both energy and particles with their environment.

Consider our system in a state  $s$  with energy  $E_s$  and number  $N_s$ , together with a bath with energy  $E_2 = E - E_s$  and number  $N_2 = N - N_s$  (Fig. 3.3). By analogy with eqn 6.3, the probability density that the system will be in state  $s$  is proportional to

$$\begin{aligned} \rho(s) &\propto \Omega_2(E - E_s, N - N_s) \\ &= \exp((S_2(E - E_s, N - N_s))/k_B) \\ &\propto \exp\left(\left(-E_s \frac{\partial S_2}{\partial E} - N_s \frac{\partial S_2}{\partial N}\right)/k_B\right) \\ &= \exp(-E_s/k_B T + N_s \mu/k_B T) \\ &= \exp(-(E_s - \mu N_s)/k_B T), \end{aligned} \quad (6.33)$$

where

$$\mu = -T \partial S / \partial N \quad (6.34)$$

is the chemical potential. Notice the factor of  $-T$ ; this converts the entropy change into an energy change. Using  $dE = T dS - P dV + \mu dN$ , we see that  $\mu = (\partial E / \partial N)|_{S, V}$  is precisely the energy change needed to add an additional particle adiabatically and keep the  $(N + 1)$ -particle system in equilibrium. At low temperatures a given system will fill with particles until the energy needed to jam in another particle reaches  $\mu$ , and then exhibit thermal number fluctuations around that filling.

Again, just as for the canonical ensemble, there is a normalization factor called the grand partition function

$$\Xi(T, V, \mu) = \sum_n e^{-(E_n - \mu N_n)/k_B T}, \quad (6.35)$$

the probability density of state  $s_i$  is  $\rho(s_i) = e^{-(E_i - \mu N_i)/k_B T} / \Xi$ . There is a grand free energy

$$\Phi(T, V, \mu) = -k_B T \log(\Xi) = \langle E \rangle - TS - \mu N \quad (6.36)$$

analogous to the Helmholtz free energy  $A(T, V, N)$ . In Exercise 6.8 you shall derive the Euler relation  $E = TS - PV + \mu N$ , and hence show that  $\Phi(T, \mu, V) = -PV$ .

**Partial traces.**<sup>14</sup> Note in passing that we can write the grand canonical partition function as a sum over canonical partition functions. Let us separate the sum over states  $n$  of our system into a double sum—an inner restricted sum<sup>15</sup> over states of fixed number of particles  $M$  in the

<sup>14</sup>The classical mechanics integrals over phase space become traces over states in Hilbert space in quantum mechanics. Removing some of the degrees of freedom in quantum mechanics is done by a partial trace over the states (Chapter 7). The name ‘partial trace’ for removing some of the degrees of freedom has also become standard in classical statistical physics (as in note 5 on page 107).

<sup>15</sup>This restricted sum is said to *integrate over* the internal degrees of freedom  $\ell_M$ .

system and an outer sum over  $M$ . Let  $s_{\ell_M, M}$  have energy  $E_{\ell_M, M}$ , so

$$\begin{aligned}\Xi(T, V, \mu) &= \sum_M \sum_{\ell_M} e^{-(E_{\ell_M, M} - \mu M)/k_B T} \\ &= \sum_M \left( \sum_{\ell_M} e^{-E_{\ell_M, M}/k_B T} \right) e^{\mu M/k_B T} \\ &= \sum_M Z(T, V, M) e^{\mu M/k_B T} \\ &= \sum_M e^{-(A(T, V, M) - \mu M)/k_B T}.\end{aligned}\quad (6.37)$$

Again, notice how the Helmholtz free energy in the last equation plays exactly the same role as the energy plays in eqn 6.35;  $\exp(-E_n/k_B T)$  is the probability of the system being in a particular system state  $n$ , while  $\exp(-A(T, V, M)/k_B T)$  is the probability of the system having any state with  $M$  particles.

**Using the grand canonical ensemble.** The grand canonical ensemble is particularly useful for non-interacting quantum systems (Chapter 7). There each energy eigenstate can be thought of as a separate subsystem, independent of the others except for the competition between eigenstates for the particle number. A closely related ensemble emerges in chemical reactions (Section 6.6).

For now, to illustrate how to use the grand canonical ensemble, let us compute the number fluctuations. The expected number of particles for a general system is

$$\langle N \rangle = \frac{\sum_m N_m e^{-(E_m - \mu N_m)/k_B T}}{\sum_m e^{-(E_m - \mu N_m)/k_B T}} = \frac{k_B T}{\Xi} \frac{\partial \Xi}{\partial \mu} = -\frac{\partial \Phi}{\partial \mu}.\quad (6.38)$$

Just as the fluctuations in the energy were related to the specific heat (the rate of change of energy with temperature, Section 6.1), the number fluctuations are related to the rate of change of particle number with chemical potential:

$$\begin{aligned}\frac{\partial \langle N \rangle}{\partial \mu} &= \frac{\partial}{\partial \mu} \frac{\sum_m N_m e^{-(E_m - \mu N_m)/k_B T}}{\Xi} \\ &= -\frac{1}{\Xi^2} \frac{(\sum_m N_m e^{-(E_m - \mu N_m)/k_B T})^2}{k_B T} \\ &\quad + \frac{1}{k_B T} \frac{\sum_m N_m^2 e^{-(E_m - \mu N_m)/k_B T}}{\Xi} \\ &= \frac{\langle N^2 \rangle - \langle N \rangle^2}{k_B T} = \frac{\langle (N - \langle N \rangle)^2 \rangle}{k_B T}.\end{aligned}\quad (6.39)$$

## 6.4 What is thermodynamics?

Thermodynamics and statistical mechanics historically were closely tied, and often they are taught together. What is thermodynamics?

(0) **Thermodynamics** (*Oxford English dictionary*): The theory of the relations between heat and mechanical energy, and of the conversion of either into the other.

(1) **Thermodynamics is the theory that emerges from statistical mechanics in the limit of large systems.** Statistical mechanics originated as a derivation of thermodynamics from an atomistic microscopic theory (somewhat before the existence of atoms was universally accepted). Thermodynamics can be viewed as statistical mechanics in the limit<sup>16</sup> as the number of particles  $N \rightarrow \infty$ . When we calculate the relative fluctuations in properties like the energy or the pressure and show that they vanish like  $1/\sqrt{N}$ , we are providing a microscopic justification for thermodynamics. Thermodynamics is the statistical mechanics of near-equilibrium systems when one ignores the fluctuations.

<sup>16</sup>The limit  $N \rightarrow \infty$  is thus usually called the *thermodynamic limit*.

In this text, we will summarize many of the important methods and results of traditional thermodynamics in the exercises (see the index of this book under ‘Exercises, thermodynamics’). Our discussions of order parameters (Chapter 9) will be providing thermodynamic laws, broadly speaking, for a wide variety of states of matter.

Statistical mechanics has a broader purview than thermodynamics. Particularly in applications to other fields like information theory, dynamical systems, and complexity theory, statistical mechanics describes many systems where the emergent behavior does not have a recognizable relation to thermodynamics.

(2) **Thermodynamics is a self-contained theory.** Thermodynamics can be developed as an axiomatic system. It rests on the so-called three laws of thermodynamics, which for logical completeness must be supplemented by a ‘zeroth’ law. Informally, they are as follows.

- (0) *Transitivity of equilibria.* If two systems are in equilibrium with a third, they are in equilibrium with one another.
- (1) *Conservation of energy.* The total energy of an isolated system, including the heat energy, is constant.
- (2) *Entropy always increases.* An isolated system may undergo irreversible processes, whose effects can be measured by a state function called the entropy.
- (3) *Entropy goes to zero at absolute zero.* The entropy per particle of any two large equilibrium systems will approach the same value<sup>17</sup> as the temperature approaches absolute zero.

<sup>17</sup>This value is set to zero by measuring phase-space volume in units of  $h^{3N}$  (Section 3.5).

The zeroth law (transitivity of equilibria) becomes the basis for defining the temperature. Our statistical mechanics derivation of the temperature in Section 3.3 provides the microscopic justification of the zeroth law: systems that can only exchange heat energy are in equilibrium with one another when they have a common value of  $1/T = (\partial S/\partial E)|_{V,N}$ .

The first law (conservation of energy) is now a fundamental principle of physics. Thermodynamics automatically inherits it from the microscopic theory. Historically, the thermodynamic understanding of how

work transforms into heat was important in establishing that energy is conserved. Careful arguments about the energy transfer due to heat flow and mechanical work<sup>18</sup> are central to thermodynamics.

The second law (entropy always increases) is the heart of thermodynamics,<sup>19</sup> and was the theme of Chapter 5.

The third law (entropy goes to zero at  $T = 0$ , also known as Nernst's theorem) basically reflects the fact that quantum systems at absolute zero are in a ground state. Since the number of ground states of a quantum system typically is small<sup>20</sup> and the number of particles is large, equilibrium systems at absolute zero have zero entropy per particle.

The laws of thermodynamics have been written in many equivalent ways.<sup>21</sup> Carathéodory [23, 24], for example, states the second law as

There are states of a system, differing infinitesimally from a given state, which are unattainable from that state by any quasi-static adiabatic<sup>22</sup> process.

The axiomatic form of the subject has attracted the attention of mathematicians ever since Carathéodory. In this text, we will not attempt to derive properties axiomatically or otherwise from the laws of thermodynamics; we focus on statistical mechanics.

**(3) Thermodynamics is a zoo of partial derivatives, transformations, and relations.** More than any other field of science, the thermodynamics literature seems filled with partial derivatives and tricky relations between varieties of physical quantities.

This is in part because there are several alternative free energies to choose among. For studying molecular systems one has not only the entropy (or the internal energy), the Helmholtz free energy, and the grand free energy, but also the Gibbs free energy, the enthalpy, and a number of others. There are corresponding free energies for studying magnetic systems, where instead of particles one studies the local magnetization or spin. There appears to be little consensus across textbooks on the symbols or even the names for these various free energies (see the inside front cover of this text).

How do we transform from one free energy to another? Let us write out the Helmholtz free energy in more detail:

$$A(T, V, N) = E - TS(E, V, N). \quad (6.40)$$

The terms on the right-hand side of the equation involve four variables:  $T$ ,  $V$ ,  $N$ , and  $E$ . Why is  $A$  not a function also of  $E$ ? Consider the derivative of  $A = E_s - T_b S_s(E_s)$  with respect to the energy  $E_s$  of the system, at fixed bath temperature  $T_b$ :

$$\partial A / \partial E_s = 1 - T_b \partial S_s / \partial E_s = 1 - T_b / T_s. \quad (6.41)$$

Since  $A$  represents the system in equilibrium with the bath, the temperature of the system and the bath must agree, and hence  $\partial A / \partial E = 0$ ;  $A$  is independent of  $E$ . Physically, energy is transferred until  $A$  is a minimum;  $E$  is no longer an independent variable. This is an example

<sup>18</sup>As we saw in our analysis of the Carnot cycle in Section 5.1.

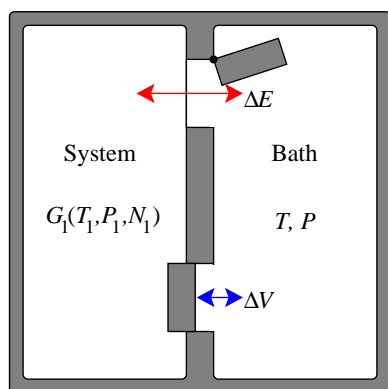
<sup>19</sup>In *The Two Cultures*, C. P. Snow suggests being able to describe the second law of thermodynamics is to science as having read a work of Shakespeare is to the arts. (Some in non-English speaking cultures may wish to object.) Remembering which law is which number is not of great import, but the concept of entropy and its inevitable increase is indeed central.

<sup>20</sup>Some systems have multiple degenerate ground states, but the number of such states is typically constant or slowly growing with system size, so the entropy per particle goes to zero. Glasses have large residual entropy, (Section 5.2.2), but are not in equilibrium.

<sup>21</sup>Occasionally you hear the first and second laws stated: (1) you can't win; and (2) you can't break even. Popular versions of the zeroth and third laws are not as compelling.

<sup>22</sup>Carathéodory is using the term *adiabatic* just to exclude heat flow; we use it to also imply infinitely slow (quasi-static) transitions.

<sup>23</sup>These formulæ have precise meanings in differential geometry, where the terms  $dX$  are *differential forms*. Thermodynamics distinguishes between *exact* differentials like  $dS$  and *inexact* differentials like work and heat which are not derivatives of a state function, but path-dependent quantities. Mathematicians have *closed* and *exact* differential forms, which (in a simply-connected space) both correspond to the exact differentials in thermodynamics. The relation between closed and exact differential forms gives a type of *cohomology theory*, etc. These elegant topics are not central to statistical mechanics, and we will not pursue them here.



**Fig. 6.4** The Gibbs ensemble  $G(T, P, N)$  embodies the thermodynamics of systems that can exchange heat and volume with a bath. The **enthalpy**  $H(S, P, N)$  is used for systems that only exchange volume.

<sup>24</sup>For example, there are useful tricks to take the derivative of  $S(E, V, N)$  with respect to  $P$  at constant  $T$  without re-expressing it in the variables  $P$  and  $T$  [52].

of a *Legendre transformation* (Exercise 6.7). Legendre transformations allow one to change from one type of energy or free energy to another, by changing from one set of independent variables (here  $E, V$ , and  $N$ ) to another ( $T, V$ , and  $N$ ).

Thermodynamics seems cluttered in part also because it is so powerful. Almost any macroscopic property of interest can be found by taking derivatives of the free energy. First derivatives of the entropy, energy, or free energy give properties like the temperature and pressure. Thermodynamics introduces a condensed notation to help organize these derivatives. For example,<sup>23</sup>

$$dE = T dS - P dV + \mu dN \tag{6.42}$$

basically asserts that  $E(S, V, N)$  satisfies eqns 3.29, 3.36, and 3.38:

$$\left. \frac{\partial E}{\partial S} \right|_{N,V} = T, \quad \left. \frac{\partial E}{\partial V} \right|_{N,S} = -P, \quad \text{and} \quad \left. \frac{\partial E}{\partial N} \right|_{V,S} = \mu. \tag{6.43}$$

The corresponding equation for the Helmholtz free energy  $A(T, V, N)$  is

$$dA = d(E - TS) = dE - T dS - S dT = -S dT - P dV + \mu dN, \tag{6.44}$$

which satisfies

$$\left. \frac{\partial A}{\partial T} \right|_{N,V} = -S, \quad \left. \frac{\partial A}{\partial V} \right|_{N,T} = -P, \quad \text{and} \quad \left. \frac{\partial A}{\partial N} \right|_{V,T} = \mu. \tag{6.45}$$

Similarly, systems at constant temperature and pressure (for example, most biological and chemical systems) minimize the *Gibbs free energy* (Fig. 6.4)

$$G(T, P, N) = E - TS + PV, \quad dG = -S dT + V dP + \mu dN. \tag{6.46}$$

Systems at constant entropy and pressure minimize the *enthalpy*

$$H(S, P, N) = E + PV, \quad dH = T dS + V dP + \mu dN, \tag{6.47}$$

and, as noted in Section 6.3, systems at constant temperature, volume, and chemical potential are described by the grand free energy

$$\Phi(T, V, \mu) = E - TS - \mu N, \quad d\Phi = -S dT - P dV - N d\mu. \tag{6.48}$$

There are also many tricky, unintuitive relations in thermodynamics. The first derivatives must agree around a tiny triangle (Fig. 3.4), yielding a relation between their products (eqn 3.33, Exercise 3.10). Second derivatives of the free energy give properties like the specific heat, the bulk modulus, and the magnetic susceptibility. The second derivatives must be symmetric ( $\partial^2/\partial x \partial y = \partial^2/\partial y \partial x$ ), giving Maxwell relations between what naively seem like different susceptibilities (Exercise 3.11). There are further tricks involved with taking derivatives in terms of ‘unnatural variables’,<sup>24</sup> and there are many inequalities that can be derived



from stability criteria.

Of course, statistical mechanics is not really different from thermodynamics; it inherits the entire zoo of complex relationships. Indeed, statistical mechanics has its own collection of important relations that connect equilibrium fluctuations to transport and response, like the Einstein relation connecting fluctuations to diffusive transport in Section 2.3 and the fluctuation–dissipation theorem we will derive in Chapter 10. In statistical mechanics, though, the focus of attention is usually not on the general relations between properties, but on calculating the properties of specific systems.

## 6.5 Mechanics: friction and fluctuations

A mass  $m$  hangs on the end of a spring with spring constant  $K$  and unstretched length  $h_0$ , subject to a gravitational field of strength  $g$ . How far does the spring stretch? We have all solved innumerable statics exercises of this sort in first-year mechanics courses. The spring stretches to a length  $h^*$  where  $-mg = K(h^* - h_0)$ . At  $h^*$  the forces balance and the energy is minimized.

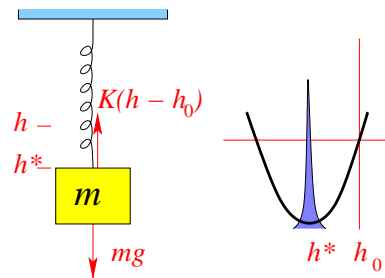
What principle of physics is this? In physics, energy is conserved, not minimized! Should we not be concluding that the mass will oscillate with a constant amplitude forever?

We have now come to the point in your physics education where we can finally explain why the mass appears to minimize energy. Here our system (the mass and spring)<sup>25</sup> is coupled to a very large number  $N$  of internal atomic or molecular degrees of freedom. The oscillation of the mass is coupled to these other degrees of freedom (friction) and will share its energy with them. The vibrations of the atoms is heat; the energy of the pendulum is dissipated by friction into heat. Indeed, since the spring potential energy is quadratic we can use the equipartition theorem: in equilibrium  $\frac{1}{2}K(h - h^*)^2 = \frac{1}{2}k_B T$ . For a spring with  $K = 10 \text{ N/m}$  at room temperature ( $k_B T = 4 \times 10^{-21} \text{ J}$ ),  $\sqrt{\langle (h - h^*)^2 \rangle} = \sqrt{k_B T / K} = 2 \times 10^{-11} \text{ m} = 0.2 \text{ \AA}$ . The position indeed minimizes the energy up to thermal fluctuations smaller than an atomic radius.<sup>26</sup>

How do we connect this statistical mechanics picture to the friction coefficient of the damped harmonic oscillator? A careful statistical mechanics treatment (Exercise 10.7) gives a law of motion for the mass of the form

$$\ddot{h} = -\frac{K}{m}(h - h^*) - \gamma\dot{h} + \xi(t), \quad (6.49)$$

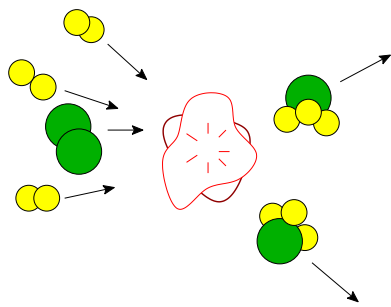
where  $\gamma$  represents the friction or *dissipation*, and  $\xi(t)$  is a random, time-dependent noise force coming from the internal vibrational degrees of freedom of the system. This is an example of a *Langevin equation*. The strength of the noise  $\xi$  depends on the dissipation  $\gamma$  and the temperature  $T$  so as to guarantee a Boltzmann distribution as the steady state. In general both  $\xi$  and  $\gamma$  can be frequency dependent; we will study these issues in detail in Chapter 10.



**Fig. 6.5** A mass on a spring in equilibrium sits very close to the minimum of the energy.

<sup>25</sup>We think of the subsystem as being just the macroscopic configuration of mass and spring, and the atoms comprising them as being part of the environment, the rest of the system.

<sup>26</sup>We will return to the fluctuating harmonic oscillator in Exercise 10.3.



**Fig. 6.6 Ammonia collision.** The simple motivating argument for the law of mass-action views the reaction as a simultaneous collision of all the reactants.

<sup>27</sup>Experimentally it is more common to work at constant pressure, which makes things more complicated but conceptually no more interesting.

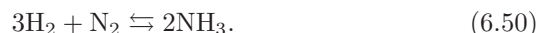
<sup>28</sup>More generally, we can write a reaction as  $\sum_i \nu_i A_i = 0$ . Here the  $\nu_i$  are the *stoichiometries*, giving the number of molecules of type  $A_i$  changed during the reaction (with  $\nu_i < 0$  for reactants and  $\nu_i > 0$  for products). The law of mass-action in general states that  $\prod_i [A_i]^{\nu_i} = K_{\text{eq}}$ .

<sup>29</sup>The Haber–Bosch process used industrially for producing ammonia involves several intermediate states. The nitrogen and hydrogen molecules adsorb (stick) onto an iron substrate, and disassociate into atoms. The nitrogen atom picks up one hydrogen atom at a time. Finally, the  $\text{NH}_3$  molecule desorbs (leaves the surface) into the vapor. The iron acts as a *catalyst*, lowering the energy barrier and speeding up the reaction without itself being consumed. (Protein catalysts in biology are called *enzymes*.)

## 6.6 Chemical equilibrium and reaction rates

In studying chemical reactions, one is often interested in the number of molecules of various types as a function of time, and not interested in observing properties depending on the positions or momenta of the molecules. In this section we develop a free energy to derive the laws of chemical equilibrium, and in particular the *law of mass-action*. We will then discuss more carefully the subtle question of exactly when the chemical reaction takes place, and motivate the *Arrhenius law* of thermally-activated reaction rates.

Chemical reactions change one type of molecule into another. For example, ammonia ( $\text{NH}_3$ ) can be produced from hydrogen and nitrogen through the reaction



All chemical reactions are in principle reversible, although the backward reaction rate may be very different from the forward rate. In *chemical equilibrium*,<sup>27</sup> the concentrations  $[X]$  of the various molecules  $X$  (in number per unit volume, say) satisfy the law of mass-action<sup>28</sup>

$$\frac{[\text{NH}_3]^2}{[\text{N}_2][\text{H}_2]^3} = K_{\text{eq}}(T). \quad (6.51)$$

The law of mass-action can naively be motivated by imagining a chemical reaction arising from a simultaneous collision of all the reactants. The probability of one nitrogen and three hydrogen molecules colliding in a small reaction region is proportional to the nitrogen concentration and to the cube of the hydrogen concentration, so the forward reaction would occur with some rate per unit volume  $K_F[\text{N}_2][\text{H}_2]^3$ ; similarly the backward reaction would occur with a rate per unit volume  $K_B[\text{NH}_3]^2$  proportional to the probability that two  $\text{NH}_3$  molecules will collide. Balancing these two rates to get a steady state gives us eqn 6.51 with  $K_{\text{eq}} = K_F/K_B$ .

This naive motivating argument becomes unconvincing when one realizes that the actual reaction may proceed through several short-lived intermediate states—at no point is a multiple collision required.<sup>29</sup> How can we derive the law of mass-action soundly from statistical mechanics?

Since we are uninterested in the positions and momenta, at fixed volume and temperature our system is described by a Helmholtz free energy  $A(T, V, N_{\text{H}_2}, N_{\text{N}_2}, N_{\text{NH}_3})$ . When the chemical reaction takes place, it changes the number of the three molecules, and changes the free energy of the system:

$$\begin{aligned} \Delta A &= \frac{\partial A}{\partial N_{\text{H}_2}} \Delta N_{\text{H}_2} + \frac{\partial A}{\partial N_{\text{N}_2}} \Delta N_{\text{N}_2} + \frac{\partial A}{\partial N_{\text{NH}_3}} \Delta N_{\text{NH}_3} \\ &= -3\mu_{\text{H}_2} - \mu_{\text{N}_2} + 2\mu_{\text{NH}_3}, \end{aligned} \quad (6.52)$$

where  $\mu_X = \partial A / \partial X$  is the chemical potential of molecule  $X$ . The

reaction will proceed until the free energy is at a minimum, so

$$-3\mu_{\text{H}_2} - \mu_{\text{N}_2} + 2\mu_{\text{NH}_3} = 0 \quad (6.53)$$

in equilibrium.

To derive the law of mass-action, we must now make an assumption: that the molecules are uncorrelated in space.<sup>30</sup> This makes each molecular species into a separate ideal gas. The Helmholtz free energies of the three gases are of the form

$$A(N, V, T) = Nk_B T [\log((N/V)\lambda^3) - 1] + NF_0, \quad (6.54)$$

where  $\lambda = h/\sqrt{2\pi mk_B T}$  is the thermal deBroglie wavelength. The first two terms give the contribution to the partition function from the positions and momenta of the molecules (eqn 6.24); the last term  $NF_0$  comes from the internal free energy of the molecules.<sup>31</sup> So, the chemical potential is

$$\begin{aligned} \mu(N, V, T) &= \frac{\partial A}{\partial N} = k_B T [\log((N/V)\lambda^3) - 1] + Nk_B T(1/N) + F_0 \\ &= k_B T \log((N/V)\lambda^3) + F_0 \\ &= k_B T \log(N/V) + c + F_0, \end{aligned} \quad (6.55)$$

where the constant  $c = k_B T \log(\lambda^3)$  is independent of density. Using eqn 6.55 in eqn 6.53, dividing by  $k_B T$ , writing concentrations  $[X] = N_X/V$ , and pulling terms independent of concentrations to the right, we find the law of mass-action:

$$\begin{aligned} -3 \log[\text{H}_2] - \log[\text{N}_2] + 2 \log[\text{NH}_3] &= \log(K_{\text{eq}}), \\ \implies \frac{[\text{NH}_3]^2}{[\text{H}_2]^3 [\text{N}_2]} &= K_{\text{eq}}. \end{aligned} \quad (6.56)$$

We also find that the equilibrium constant depends exponentially on the net internal free energy difference  $\Delta F_{\text{net}} = -3F_0^{\text{H}_2} - F_0^{\text{N}_2} + 2F_0^{\text{NH}_3}$  between reactants and products:

$$K_{\text{eq}} = K_0 \exp(-\Delta F_{\text{net}}/k_B T) \quad (6.57)$$

with a prefactor

$$K_0 = \frac{\lambda_{\text{H}_2}^9 \lambda_{\text{N}_2}^3}{\lambda_{\text{NH}_3}^6} = \frac{h^6 m_{\text{NH}_3}^3}{8\pi^3 k_B^3 T^3 m_{\text{H}_2}^{9/2} m_{\text{N}_2}^{3/2}} \propto T^{-3} \quad (6.58)$$

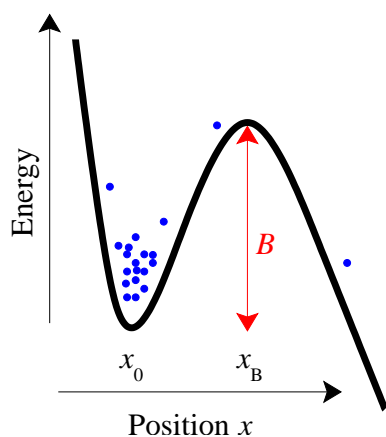
that depends weakly on the temperature. The factor  $e^{-\Delta F_{\text{net}}/k_B T}$  represents the Boltzmann factor favoring a final state with molecular free energy  $\Delta F_{\text{net}}$  lower than the initial state. The temperature dependence of the prefactor (four molecules have more momentum-space entropy than two), and the temperature dependence of the molecular free energies  $F_0$  (see note 31), are usually weak compared to the exponential dependence on the difference in molecular ground-state energies  $\Delta E_{\text{net}}$ :

$$K_{\text{eq}} \propto \exp(-\Delta E_{\text{net}}/k_B T), \quad (6.59)$$

<sup>30</sup>This assumption is also often valid for ions and atoms in solution; if the ion-ion interactions can be neglected and the solute (water) is not important, the ions are well described as ideal gases, with corrections due to integrating out the solvent degrees of freedom.

<sup>31</sup>For atoms in their ground state,  $F_0$  is the ground-state energy  $E_0$ . For small spinless molecules near room temperature, the internal free energy  $F_0$  is usually dominated by the molecular ground-state energy  $E_0$ , with a classical contribution from rotational motion; vibrations and internal electronic excitations are frozen out. In this regime, the homonuclear diatomic molecules  $\text{H}_2$  and  $\text{N}_2$  have  $F_0 = E_0 - k_B T \log(IT/h^2)$ , where  $I$  is the moment of inertia; ammonia with three moments of inertia has  $F_0 = E_0 - k_B T \log(\sqrt{8\pi T^3 I_1 I_2 I_3}/3h^3)$  (see [71, sections 47-51]).

<sup>32</sup>Ammonia synthesis is *exothermic*, releasing energy. The reverse reaction, consuming ammonia to make nitrogen and hydrogen is *endothermic*.



**Fig. 6.7 Barrier-crossing potential.** Energy  $E$  as a function of some reaction coordinate  $X$  for a chemical reaction. The dots schematically represent how many atoms are at each position. The reactants (left) are separated from the products (right) by an energy barrier of height  $B$ . One can estimate the rate of the reaction by calculating the number of reactants crossing the top of the barrier per unit time.

<sup>33</sup>The picture 6.7 applies to barrier-crossing problems in extended systems, like diffusion in crystals and atomic transitions between metastable states (glasses, Section 5.2.2; biomolecules, Exercise 6.4; and nanojunctions, Exercise 10.5). In each of these systems, this partial trace leaves us with a discrete set of states.

<sup>34</sup>Crowding could change this. For example, a surface catalyst where the product does not leave the surface could stop reacting as the product covers the active sites.

<sup>35</sup>Re-crossing is a *dynamical correction* to transition-state theory; see [55].

<sup>36</sup>At low temperatures, it is mainly important that this surface be perpendicular to the unstable ‘downward’ eigendirection of the Hessian (second derivative matrix) for the potential energy at the transition state.

with  $\Delta E_{\text{net}} = 92.4 \text{ kJ/mole}$  for the ammonia synthesis reaction.<sup>32</sup> Equilibrium constants usually grow in the thermally-activated form suggested by eqn 6.57.

We now go beyond chemical equilibrium, to consider the rates of the forward and backward reactions. To do so, we need a more precise definition of which atoms belong to which molecules. Exactly when during the trajectory do we say that the reaction has occurred?

An  $M$ -atom chemical reaction (classically) is a trajectory in a  $3M$ -dimensional configuration space. It is traditional in chemistry to pick out one ‘reaction coordinate’  $X$ , and plot the energy (minimized with respect to the other  $3M-1$  coordinates) versus  $X$ . Figure 6.7 shows this energy plot.<sup>33</sup> Notice the energy barrier  $B$  separating the reactants from the products; the atomic configuration at the top of the barrier is called the *transition state*. (This barrier, in  $3M$ -dimensional configuration space, is actually a saddlepoint; dividing the reactants from the products demands the identification of a  $(3M-1)$ -dimensional transition-state *dividing surface*.) Our free energy  $A(T, V, N_{\text{H}_2}, N_{\text{N}_2}, N_{\text{NH}_3})$  is properly a partial trace, with all configurations to the left of the transition state  $B$  contributing to the free energy of the reactants and all configurations to the right of  $B$  contributing as products.

How fast does our chemical reaction proceed, if we start out of equilibrium with extra reactants? In dilute systems where the mass-action law holds, the forward reaction rate is to a good approximation independent of the concentration of the product.<sup>34</sup> If our reactions occur slowly enough so that the molecules remain in equilibrium at the current concentrations, we can estimate the non-equilibrium reaction rate by studying the equilibrium transitions from reactant to product at the same reactant concentration.

The reaction rate cannot be larger than the total number of atoms in equilibrium crossing past the energy barrier from reactant to product. (It can be smaller if trajectories which do cross the barrier often immediately re-cross backward before equilibrating on the other side.<sup>35</sup> Such re-crossings are minimized by choosing the transition-state dividing surface properly.<sup>36</sup>) The density of particles at the top of the barrier is smaller than the density at the bottom of the well by a Boltzmann factor of  $\exp(-B/k_B T)$ . The rate of the reaction will therefore be of the thermally-activated, or *Arrhenius*, form

$$\Gamma = \Gamma_0 \exp(-B/k_B T), \quad (6.60)$$

with some prefactor  $\Gamma_0$  which will be proportional to the mass-action formula (e.g.,  $\Gamma_0 \propto [\text{H}_2]^3[\text{N}_2]$  for our ammonia formation reaction). By carefully calculating the population near the bottom of the well and the population and velocities near the top of the barrier, one can derive a formula for the constant of proportionality (see Exercise 6.11).

This Arrhenius law for thermally-activated motion governs not only chemical reaction rates, but also diffusion constants and more macro-

scopic phenomena like nucleation rates (Section 11.3).<sup>37</sup>

## 6.7 Free energy density for the ideal gas

We began our text (Section 2.2) studying the diffusion equation. How is it connected with free energies and ensembles? Broadly speaking, inhomogeneous systems out of equilibrium can also be described by statistical mechanics, if the gradients in space and time are small enough that the system is close to a *local equilibrium*. We can then represent the local state of the system by *order parameter fields*, one field for each property (density, temperature, magnetization) needed to characterize the state of a uniform, macroscopic body. We can describe a spatially-varying, inhomogeneous system that is nearly in equilibrium using a *free energy density*, typically depending on the order parameter fields and their gradients. The free energy of the inhomogeneous system will be given by integrating the free energy density.<sup>38</sup>

We will be discussing order parameter fields and free energy densities for a wide variety of complex systems in Chapter 9. There we will use symmetries and gradient expansions to derive the form of the free energy density, because it will often be too complex to compute directly. In this section, we will directly derive the free energy density for an inhomogeneous ideal gas, to give a tangible example of the general case.<sup>39</sup>

Remember that the Helmholtz free energy of an ideal gas is nicely written (eqn 6.24) in terms of the density  $\rho = N/V$  and the thermal deBroglie wavelength  $\lambda$ :

$$A(N, V, T) = Nk_B T [\log(\rho\lambda^3) - 1]. \quad (6.61)$$

Hence the free energy density for  $n_j = \rho(\mathbf{x}_j)\Delta V$  atoms in a small volume  $\Delta V$  is

$$\mathcal{F}^{\text{ideal}}(\rho(\mathbf{x}_j), T) = \frac{A(n_j, \Delta V, T)}{\Delta V} = \rho(\mathbf{x}_j)k_B T [\log(\rho(\mathbf{x}_j)\lambda^3) - 1]. \quad (6.62)$$

The probability for a given particle density  $\rho(x)$  is

$$P\{\rho\} = e^{-\beta \int dV \mathcal{F}^{\text{ideal}}(\rho(\mathbf{x}))} / Z. \quad (6.63)$$

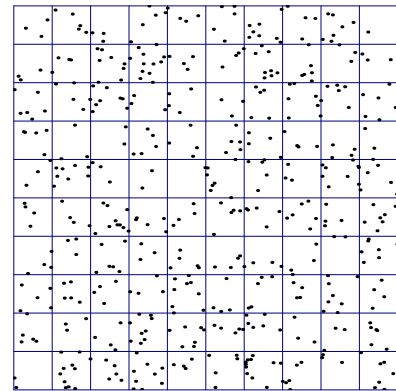
As usual, the free energy  $F\{\rho\} = \int \mathcal{F}(\rho(\mathbf{x})) d\mathbf{x}$  acts just like the energy in the Boltzmann distribution. We have *integrated out* the microscopic degrees of freedom (positions and velocities of the individual particles) and replaced them with a coarse-grained field  $\rho(x)$ . The free energy density of eqn 6.62 can be used to determine any equilibrium property of the system that can be written in terms of the density  $\rho(x)$ .<sup>40</sup>

The free energy density also provides a framework for discussing the evolution laws for non-uniform densities. A system prepared with some non-uniform density will evolve in time  $\rho(x, t)$ . If in each small volume  $\Delta V$  the system is close to equilibrium, then one may expect that its time evolution can be described by equilibrium statistical mechanics

<sup>37</sup>There are basically three ways in which slow processes arise in physics. (1) Large systems can respond slowly to external changes because communication from one end of the system to the other is sluggish; examples are the slow decay at long wavelengths in the diffusion equation (Section 2.2) and Goldstone modes (Section 9.3). (2) Systems like radioactive nuclei can respond slowly—decaying with lifetimes of billions of years—because of the slow rate of quantum tunneling through barriers. (3) Systems can be slow because they must thermally activate over barriers (with the Arrhenius rate of eqn 6.60).

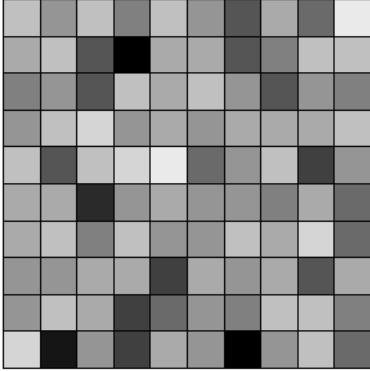
<sup>38</sup>Properly, given an order parameter field  $s(\mathbf{x})$  there is a functional  $F\{s\}$  which gives the system free energy. (A *functional* is a mapping from a space of functions into the real numbers.) Writing this functional as an integral over a free energy density (as we do) can be subtle, not only due to long-range fields, but also due to total divergence terms (Exercise 9.3).

<sup>39</sup>We will also use the free energy density of the ideal gas when we study correlation functions in Section 10.3.



**Fig. 6.8 Density fluctuations in space.** If  $n_j$  is the number of points in a box of size  $\Delta V$  at position  $\mathbf{x}_j$ , then  $\rho(\mathbf{x}_j) = n_j/\Delta V$ .

<sup>40</sup>In Chapter 10, for example, we will use it to calculate correlation functions  $\langle \rho(x)\rho(x') \rangle$ , and will discuss their relationship with susceptibilities and dissipation.



**Fig. 6.9 Coarse-grained density in space.** The density field  $\rho(\mathbf{x})$  represents all configurations of points  $\mathbb{Q}$  consistent with the average. Its free energy density  $\mathcal{F}^{\text{ideal}}(\rho(\mathbf{x}))$  contains contributions from all microstates  $(\mathbb{P}, \mathbb{Q})$  with the correct number of particles per box. The probability of finding this particular density is proportional to the integral of all ways  $\mathbb{Q}$  that the particles in Fig. 6.8 can be arranged to give this density.

<sup>41</sup>That is, the derivative in function space, giving the linear approximation to  $\int (\mathcal{F}\{\rho + \delta\rho\} - \mathcal{F}\{\rho\})$  (see note 7 on p. 218). We will seldom touch upon variational derivatives in this text.

<sup>42</sup>In that case, we would need to add the local velocity field into our description of the local environment.

<sup>43</sup>This is *linear response*. Systems that are nearly in equilibrium typically have currents proportional to gradients in their properties. Examples include Ohm's law where the electrical current is proportional to the gradient of the electromagnetic potential  $I = V/R = (1/R)(d\phi/dx)$ , thermal conductivity where the heat flow is proportional to the gradient in temperature  $\mathbf{J} = \kappa\nabla T$ , and viscous fluids, where the shear rate is proportional to the shear stress. We will study linear response with more rigor in Chapter 10.

even though it is not globally in equilibrium. A non-uniform density will have a force which pushes it towards uniformity; the total free energy will decrease when particles flow from regions of high particle density to low density. We can use our free energy density to calculate this force, and then use the force to derive laws (depending on the system) for the time evolution.

The chemical potential for a uniform system is

$$\mu = \frac{\partial A}{\partial N} = \frac{\partial A/V}{\partial N/V} = \frac{\partial \mathcal{F}}{\partial \rho},$$

i.e., the change in free energy for a change in the average density  $\rho$ . For a non-uniform system, the local chemical potential at a point  $x$  is

$$\mu(x) = \frac{\delta}{\delta \rho(x)} \int \mathcal{F}(y) dy \quad (6.64)$$

the variational derivative<sup>41</sup> of the free energy density with respect to  $\rho(x)$ . Because our ideal gas free energy has no terms involving gradients of  $\rho$ , the variational derivative  $\delta \int \mathcal{F} / \delta \rho$  equals the partial derivative  $\partial \mathcal{F} / \partial \rho$ :

$$\begin{aligned} \mu(x) &= \frac{\delta \int \mathcal{F}^{\text{ideal}}}{\delta \rho} = \frac{\partial}{\partial \rho} (\rho k_B T [\log(\rho \lambda^3) - 1]) \\ &= k_B T [\log(\rho \lambda^3) - 1] + \rho k_B T / \rho \\ &= k_B T \log(\rho \lambda^3). \end{aligned} \quad (6.65)$$

The chemical potential is like a number pressure for particles: a particle can lower the free energy by moving from regions of high chemical potential to low chemical potential. The gradient of the chemical potential  $-\partial\mu/\partial x$  is thus a pressure gradient, effectively the statistical mechanical force on a particle.

How will the particle density  $\rho$  evolve in response to this force  $\mu(x)$ ? This depends upon the problem. If our density were the density of the entire gas, the atoms would accelerate under the force—leading to sound waves.<sup>42</sup> There momentum is conserved as well as particle density. If our particles could be created and destroyed, the density evolution would include a term  $\partial\rho/\partial t = -\eta\mu$  not involving a current. In systems that conserve (or nearly conserve) energy, the evolution will depend on Hamilton's equations of motion for the free energy density; in magnets, the magnetization responds to an external force by precessing; in superfluids, gradients in the chemical potential are associated with winding and unwinding the phase of the order parameter field (vortex motion)...

Let us focus on the case of a small amount of perfume in a large body of still air. Here particle density is locally conserved, but momentum is strongly damped (since the perfume particles can scatter off of the air molecules). The velocity of our particles will be proportional to the effective force on them  $\mathbf{v} = -\gamma(\partial\mu/\partial x)$ , with  $\gamma$  the mobility.<sup>43</sup> Hence

the current  $\mathbf{J} = \rho v$  of particles will be

$$\begin{aligned} \mathbf{J} &= \gamma \rho(x) \left( -\frac{\partial \mu}{\partial x} \right) = -\gamma \rho(x) \frac{\partial k_B T \log(\rho \lambda^3)}{\partial x} \\ &= -\gamma \rho(x) \frac{k_B T}{\rho} \frac{\partial \rho}{\partial x} = -\gamma k_B T \frac{\partial \rho}{\partial x}, \end{aligned} \quad (6.66)$$

and thus the rate of change of  $\rho$  is given by the diffusion equation

$$\frac{\partial \rho}{\partial t} = -\nabla \cdot \mathbf{J} = \gamma k_B T \frac{\partial^2 \rho}{\partial x^2}. \quad (6.67)$$

Notice,

- we have again derived the diffusion equation (eqn 2.7)  $\partial \rho / \partial t = D \partial^2 \rho / \partial x^2$ , this time by starting with a free energy density from equilibrium statistical mechanics, and assuming a linear law relating velocity to force;
- we have rediscovered the Einstein relation (eqn 2.22)  $D = \gamma k_B T$ ;
- we have asserted that  $-\partial \mu / \partial x$  acts just like an external force, even though  $\mu$  comes from the ideal gas, which itself has no potential energy (see Exercises 5.12 and 6.13).

Our free energy density for the ideal gas is simpler than the free energy density of a general system because the ideal gas has no stiffness (free energy cost for gradients in the density). Our derivation above worked by splitting space into little boxes; in general, these box regions will not be independent systems, and there will be a free energy difference that depends on the change in the coarse-grained fields between boxes (e.g., the (free) energy cost to bend an elastic rod) leading to terms involving gradients of the field.

---

## Exercises

Free energies are the work-horses of statistical mechanics and thermodynamics. There are an immense number of practical applications of the various free energies in chemistry, condensed matter physics, and engineering. These exercises do not explore these applications in depth; rather, they emphasize the central themes and methods that span across fields.

*Exponential atmosphere*, *Two-state system*, and *Negative temperature* explore the most basic of statistical mechanics systems. The last also explores the links between the canonical and microcanonical ensembles. *Molecular motors* provides a biophysics example of how to construct the appropriate free energies in systems ex-

changing things other than energy, volume, and number, and introduces us to *telegraph noise* in bistable systems.

*Laplace*, *Lagrange*, and *Legendre* explore mathematical tools important in thermodynamics, and their links to statistical mechanics. *Euler*, *Gibbs–Duhem*, and *Clausius–Clapeyron* each prompt you to derive the corresponding fundamental thermodynamic relation named after them.

*Barrier crossing* introduces the quantitative methods used to calculate the rates of chemical reactions. *Michaelis–Menten and Hill* gives another example of how one integrates out degrees of freedom leading to effective theories; it derives two forms for chemical reaction

rates commonly seen in molecular biology. *Pollen and hard squares* gives an explicitly solvable example of an entropic potential free energy.

Statistics, it is sad to say, has almost no overlap with statistical mechanics in audience or vocabulary, although the subjects are tightly coupled. *Statistical mechanics and statistics* is a tiny attempt to bridge that gap, introducing Bayesian analysis.

How does one measure entropy or free energies on a computer? One cannot afford to enumerate the probabilities of every state in the ensemble; alternative methods must be used [14, 63, 94]. A computational exercise on this topic is planned for the book web site [126]

(6.1) **Exponential atmosphere.**<sup>44</sup> (Computation) ②

As you climb a mountain, the air becomes thin and cold, and typically rather windy. Are any of these effects due to equilibrium statistical mechanics? The wind is not; it is due to non-uniform heating and evaporation in far distant regions. We have determined that equilibrium statistical mechanics demands that two equilibrium bodies in contact must share the same temperature, even when one of them is above the other. But gas molecules fall down under gravity, . . .

This example is studied in [41, I.40], where Feynman uses it to deduce much of classical equilibrium statistical mechanics. Let us reproduce his argument. Download our molecular dynamics software [10] from the text web site [129] and the hints for this exercise. Simulate an ideal gas in a box with reflecting walls, under the influence of gravity. Since the ideal gas has no internal equilibration, the simulation will start in an equilibrium ensemble at temperature  $T$ .

(a) *Does the distribution visually appear statistically stationary? How is it possible to maintain a static distribution of heights, even though all the atoms are continuously accelerating downward? After running for a while, plot a his-*

*togram of the height distribution and velocity distribution. Do these distributions remain time independent, apart from statistical fluctuations? Do their forms agree with the predicted equilibrium Boltzmann distributions?*

The equilibrium thermal distribution is time independent even if there are no collisions to keep things in equilibrium. The number of atoms passing a plane at constant  $z$  from top to bottom must match the number of atoms passing from bottom to top. There are more atoms at the bottom, but many of them do not have the vertical kinetic energy to make it high enough. Macroscopically, we can use the ideal gas law ( $PV = Nk_B T$ , so  $P(z) = \rho(z)k_B T$ ) to deduce the Boltzmann distribution giving the density dependence on height.<sup>45</sup>

(b) *The pressure increases with depth due to the increasing weight of the air above. What is the force due to gravity on a slab of thickness  $\Delta z$  and area  $A$ ? What is the change in pressure from  $z$  to  $z - \Delta z$ ? Use this, and the ideal gas law, to find the density dependence on height. Does it agree with the Boltzmann distribution?*

Feynman then deduces the momentum distribution of the particles from the balancing of upward and downward particle fluxes we saw in part (a). He starts by arguing that the equilibrium probability  $\rho_v$  that a given atom has a particular vertical velocity  $v_z$  is independent of height.<sup>46</sup> (The atoms at different heights are all at the same temperature, and only differ in their overall density; since they do not interact, they do not know the density, hence the atom's velocity distribution cannot depend on  $z$ ).

(c) *If the unknown velocity distribution is  $\rho_v(v_z)$ , use it and the Boltzmann height distribution deduced in part (b) to write the joint equilibrium probability distribution  $\rho(v_z, z, t)$ .*

Now consider<sup>47</sup> the atoms with vertical velocity  $v_z$  in a slab of gas of area  $A$  between  $z$  and  $z + \Delta z$

<sup>44</sup>This exercise and the associated software were developed in collaboration with Christopher Myers.

<sup>45</sup>Feynman then notes that this macroscopic argument can be used for any external force! If  $F$  is the force on each atom, then in equilibrium the pressure must vary to balance the external force density  $F\rho$ . Hence the change in pressure  $F\rho dx = dP = d(k_B T\rho) = k_B T d\rho$ . If the force is the gradient of a potential  $U(\mathbf{x})$ , then picking a local coordinate  $x$  along the gradient of  $U$  we have  $-\nabla U = F = k_B T(d\rho/dx)/\rho = k_B T(d \log \rho)/dx = k_B T \nabla \log \rho$ . Hence  $\log \rho = C - U/k_B T$  and  $\rho \propto \exp(-U/k_B T)$ . Feynman then makes the leap from the ideal gas (with no internal potential energy) to interacting systems. . .

<sup>46</sup>At this point in the text, we already know the formula giving the velocity distribution of a classical system, and we know it is independent of position. But Feynman, remember, is re-deriving everything from scratch. Also, be warned:  $\rho$  in part (b) was the mass density; here we use it for the probability density.

<sup>47</sup>Feynman gives a complicated argument avoiding partial derivatives and gently introducing probability distributions, which becomes cleaner if we just embrace the math.



at time  $t$ . Their probability density (per unit vertical velocity) is  $\rho(v_z, z, t)A\Delta z$ . After a time  $\Delta t$ , this slab will have accelerated to  $v_z - g\Delta t$ , and risen a distance  $h + v_z\Delta t$ , so

$$\rho(v_z, z, t) = \rho(v_z - g\Delta t, z + v_z\Delta t, t + \Delta t). \quad (6.68)$$

(d) Using the fact that  $\rho(v_z, z, t)$  is time independent in equilibrium, write a relation between  $\partial\rho/\partial v_z$  and  $\partial\rho/\partial z$ . Using your result from part (c), derive the equilibrium velocity distribution for the ideal gas.

Feynman then argues that interactions and collisions will not change the velocity distribution.

(e) Simulate an interacting gas in a box with reflecting walls, under the influence of gravity. Use a temperature and a density for which there is a layer of liquid at the bottom (just like water in a glass). Plot the height distribution (which should show clear interaction effects) and the momentum distribution. Use the latter to determine the temperature; do the interactions indeed not distort the momentum distribution?

What about the atoms which evaporate from the fluid? Only the very most energetic atoms can leave the liquid to become gas molecules. They must, however, use up every bit of their extra energy (on average) to depart; their kinetic energy distribution is precisely the same as that of the liquid.<sup>48</sup>

Feynman concludes his chapter by pointing out that the predictions resulting from the classical Boltzmann distribution, although they describe many properties well, do not match experiments on the specific heats of gases, foreshadowing the need for quantum mechanics.<sup>49</sup>

### (6.2) Two-state system. ①

Consider the statistical mechanics of a tiny object with only two discrete states:<sup>50</sup> one of energy  $E_1$  and the other of higher energy  $E_2 > E_1$ .

(a) Boltzmann probability ratio. Find the ratio of the equilibrium probabilities  $\rho_2/\rho_1$  to find our system in the two states, when weakly coupled to a heat bath of temperature  $T$ . What is the limiting probability as  $T \rightarrow \infty$ ? As  $T \rightarrow$

0? Related formula: Boltzmann probability =  $Z(T) \exp(-E/kT) \propto \exp(-E/kT)$ .

(b) Probabilities and averages. Use the normalization of the probability distribution (the system must be in one or the other state) to find  $\rho_1$  and  $\rho_2$  separately. (That is, solve for  $Z(T)$  in the 'related formula' for part (a).) What is the average value of the energy  $E$ ?

### (6.3) Negative temperature. ③

A system of  $N$  atoms each can be in the ground state or in an excited state. For convenience, we set the zero of energy exactly in between, so the energies of the two states of an atom are  $\pm\varepsilon/2$ . The atoms are isolated from the outside world. There are only weak couplings between the atoms, sufficient to bring them into internal equilibrium but without other effects.

(a) Microcanonical entropy. If the net energy is  $E$  (corresponding to a number of excited atoms  $m = E/\varepsilon + N/2$ ), what is the microcanonical entropy  $S_{\text{micro}}(E)$  of our system? Simplify your expression using Stirling's formula,  $\log n! \sim n \log n - n$ .

(b) Negative temperature. Find the temperature, using your simplified expression from part (a). What happens to the temperature when  $E > 0$ ? Having the energy  $E > 0$  is a kind of population inversion. Population inversion is the driving mechanism for lasers.

For many quantities, the thermodynamic derivatives have natural interpretations when viewed as sums over states. It is easiest to see this in small systems.

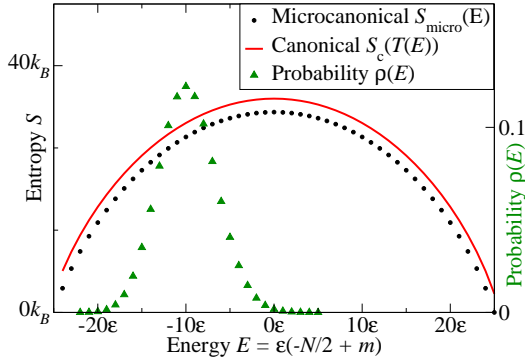
(c) Canonical ensemble. (i) Take one of our atoms and couple it to a heat bath of temperature  $k_B T = 1/\beta$ . Write explicit formulae for  $Z_{\text{canon}}$ ,  $E_{\text{canon}}$ , and  $S_{\text{canon}}$  in the canonical ensemble, as a trace (or sum) over the two states of the atom. ( $E$  should be the energy of each state multiplied by the probability  $\rho_n$  of that state, and  $S$  should be the trace of  $-k_B \rho_n \log \rho_n$ .) (ii) Compare the results with what you get by using the thermodynamic relations. Using  $Z$  from the trace over states, calculate the Helmholtz free energy  $A$ ,  $S$  as a derivative of  $A$ , and  $E$  from  $A = E - TS$ .

<sup>48</sup>Ignoring quantum mechanics.

<sup>49</sup>Quantum mechanics is important for the internal vibrations within molecules, which absorb energy as the gas is heated. Quantum effects are not so important for the pressure and other properties of gases, which are dominated by the molecular center-of-mass motions.

<sup>50</sup>Visualize this as a tiny biased coin, which can be in the 'heads' or 'tails' state but has no other internal vibrations or center of mass degrees of freedom. Many systems are well described by large numbers of these two-state systems: some paramagnets, carbon monoxide on surfaces, glasses at low temperatures, ...

Do the thermodynamically derived formulæ you get agree with the statistical traces?  
 (d) What happens to  $E$  in the canonical ensemble as  $T \rightarrow \infty$ ? Can you get into the negative-temperature regime discussed in part (b)?

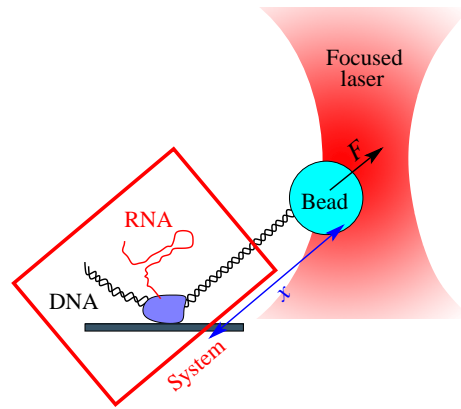


**Fig. 6.10 Negative temperature.** Entropies and energy fluctuations for this problem with  $N = 50$ . The canonical probability distribution for the energy is for  $\langle E \rangle = -10\epsilon$ , and  $k_B T = 1.207\epsilon$ . You may wish to check some of your answers against this plot.

(e) Canonical–microcanonical correspondence. Find the entropy in the canonical distribution for  $N$  of our atoms coupled to the outside world, from your answer to part (c). Explain the value of  $S(T = \infty) - S(T = 0)$  by counting states. Using the approximate form of the entropy from part (a) and the temperature from part (b), show that the canonical and microcanonical entropies agree,  $S_{\text{micro}}(E) = S_{\text{canon}}(T(E))$ . (Perhaps useful:  $\text{arctanh}(x) = \frac{1}{2} \log \left( \frac{1+x}{1-x} \right)$ .) Notice that the two are not equal in Fig. 6.10; the form of Stirling’s formula we used in part (a) is not very accurate for  $N = 50$ . Explain in words why the microcanonical entropy is smaller than the canonical entropy.  
 (f) Fluctuations. Calculate the root-mean-square energy fluctuations in our system in the canonical ensemble. Evaluate it at  $T(E)$  from part (b). For large  $N$ , are the fluctuations in  $E$  small compared to  $E$ ?

(6.4) **Molecular motors and free energies.**<sup>51</sup> (Biology) ②

Figure 6.11 shows the set-up of an experiment on the molecular motor RNA polymerase that transcribes DNA into RNA.<sup>52</sup> Choosing a good ensemble for this system is a bit involved. It is under two constant forces ( $F$  and pressure), and involves complicated chemistry and biology. Nonetheless, you know some things based on fundamental principles. Let us consider the optical trap and the distant fluid as being part of the external environment, and define the ‘system’ as the local region of DNA, the RNA, motor, and the fluid and local molecules in a region immediately enclosing the region, as shown in Fig. 6.11.



**Fig. 6.11 RNA polymerase molecular motor** attached to a glass slide is pulling along a DNA molecule (transcribing it into RNA). The opposite end of the DNA molecule is attached to a bead which is being pulled by an optical trap with a constant external force  $F$ . Let the distance from the motor to the bead be  $x$ ; thus the motor is trying to move to decrease  $x$  and the force is trying to increase  $x$ .

(a) Without knowing anything further about the chemistry or biology in the system, which of the following must be true on average, in all cases?  
 (T) (F) The total entropy of the Universe (the system, bead, trap, laser beam, ...) must increase or stay unchanged with time.  
 (T) (F) The entropy  $S_s$  of the system must increase with time.

<sup>51</sup>This exercise was developed with the help of Michelle Wang.

<sup>52</sup>RNA, ribonucleic acid, is a long polymer like DNA, with many functions in living cells. It has four monomer units (A, U, C, and G: Adenine, Uracil, Cytosine, and Guanine); DNA has T (Thymine) instead of Uracil. Transcription just copies the DNA sequence letter for letter into RNA, except for this substitution.

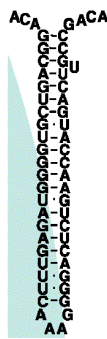
(T) (F) The total energy  $E_T$  of the Universe must decrease with time.

(T) (F) The energy  $E_s$  of the system must decrease with time.

(T) (F)  $G_s - Fx = E_s - TS_s + PV_s - Fx$  must decrease with time, where  $G_s$  is the Gibbs free energy of the system. Related formula:  $G = E - TS + PV$ .

(Hint: Precisely two of the answers are correct.)

The sequence of monomers on the RNA can encode information for building proteins, and can also cause the RNA to fold into shapes that are important to its function. One of the most important such structures is the hairpin (Fig. 6.12). Experimentalists study the strength of these hairpins by pulling on them (also with laser tweezers). Under a sufficiently large force, the hairpin will unzip. Near the threshold for unzipping, the RNA is found to jump between the zipped and unzipped states, giving telegraph noise<sup>53</sup> (Fig. 6.13). Just as the current in a telegraph signal is either on or off, these systems are bistable and make transitions from one state to the other; they are a two-state system.



**Fig. 6.12 Hairpins in RNA.** (Reprinted with permission from Liphardt et al. [82], ©2001 AAAS.) A length of RNA attaches to an inverted, complementary strand immediately following, forming a hairpin fold.

The two RNA configurations presumably have different energies ( $E_z, E_u$ ), entropies ( $S_z, S_u$ ), and volumes ( $V_z, V_u$ ) for the local region around the zipped and unzipped states, respectively. The environment is at temperature  $T$  and pres-

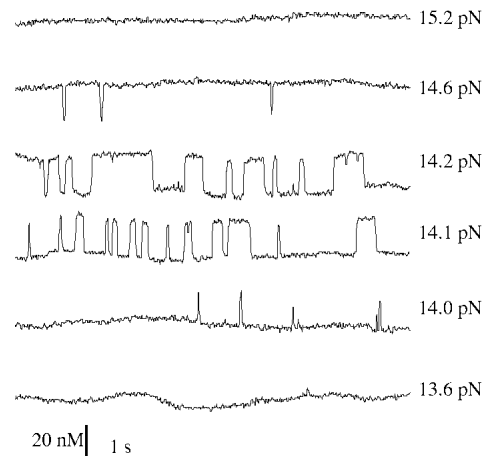
sure  $P$ . Let  $L = L_u - L_z$  be the extra length of RNA in the unzipped state. Let  $\rho_z$  be the fraction of the time our molecule is zipped at a given external force  $F$ , and  $\rho_u = 1 - \rho_z$  be the unzipped fraction of time.

(b) Of the following statements, which are true, assuming that the pulled RNA is in equilibrium? (T) (F)  $\rho_z/\rho_u = \exp((S_z^{\text{tot}} - S_u^{\text{tot}})/k_B T)$ , where  $S_z^{\text{tot}}$  and  $S_u^{\text{tot}}$  are the total entropy of the Universe when the RNA is in the zipped and unzipped states, respectively.

(T) (F)  $\rho_z/\rho_u = \exp(-(E_z - E_u)/k_B T)$ .

(T) (F)  $\rho_z/\rho_u = \exp(-(G_z - G_u)/k_B T)$ , where  $G_z = E_z - TS_z + PV_z$  and  $G_u = E_u - TS_u + PV_u$  are the Gibbs energies in the two states.

(T) (F)  $\rho_z/\rho_u = \exp(-(G_z - G_u + FL)/k_B T)$ , where  $L$  is the extra length of the unzipped RNA and  $F$  is the applied force.



**Fig. 6.13 Telegraph noise in RNA unzipping.** (Reprinted with permission from Liphardt et al. [82], ©2001 AAAS.) As the force increases, the fraction of time spent in the zipped state decreases.

(6.5) **Laplace.**<sup>54</sup> (Thermodynamics) ②

The Laplace transform of a function  $f(t)$  is a function of  $x$ :

$$\mathcal{L}\{f\}(x) = \int_0^\infty f(t)e^{-xt} dt. \quad (6.69)$$

<sup>53</sup>Like a telegraph key going on and off at different intervals to send dots and dashes, a system showing telegraph noise jumps between two states at random intervals.

<sup>54</sup>Pierre-Simon Laplace (1749–1827). See [89, section 4.3].

Show that the canonical partition function  $Z(\beta)$  can be written as the Laplace transform of the microcanonical volume of the energy shell  $\Omega(E)$ .

(6.6) **Lagrange.**<sup>55</sup> (Thermodynamics) ③

Lagrange multipliers allow one to find the extremum of a function  $f(\mathbf{x})$  given a constraint  $g(\mathbf{x}) = g_0$ . One sets the derivative of

$$f(\mathbf{x}) + \lambda(g(\mathbf{x}) - g_0) \quad (6.70)$$

with respect to  $\lambda$  and  $\mathbf{x}$  to zero. The derivatives with respect to components of  $\mathbf{x}$  then include terms involving  $\lambda$ , which act to enforce the constraint. Setting the derivative with respect to  $\lambda$  to zero determines  $\lambda$ .

Let us use Lagrange multipliers to find the maximum of the non-equilibrium entropy

$$\begin{aligned} S &= -k_B \int \rho(\mathbb{P}, \mathbb{Q}) \log \rho(\mathbb{P}, \mathbb{Q}) \\ &= -k_B \text{Tr}(\rho \log \rho) \\ &= -k_B \sum p_i \log p_i \end{aligned} \quad (6.71)$$

constraining the normalization, energy, and number. You may use whichever form of the entropy you prefer; the first continuous form will demand some calculus of variations; the last (discrete) form is the most straightforward.

(a) Microcanonical. *Using a Lagrange multiplier to enforce the normalization  $\sum_i p_i = 1$ , show that the probability distribution that extremizes the entropy is a constant (the microcanonical distribution).*

(b) Canonical. *Integrating over all  $\mathbb{P}$  and  $\mathbb{Q}$ , use another Lagrange multiplier to fix the mean energy  $\langle E \rangle = \sum_i E_i p_i$ . Show that the canonical distribution maximizes the entropy given the constraints of normalization and fixed energy.*

(c) Grand canonical. *Summing over different numbers of particles  $N$  and adding the constraint that the average number is  $\langle N \rangle = \sum_i N_i p_i$ , show that you get the grand canonical distribution by maximizing the entropy.*

(6.7) **Legendre.**<sup>56</sup> (Thermodynamics) ③

The Legendre transform of a function  $f(t)$  is given by minimizing  $f(x) - xp$  with respect to  $x$ , so that  $p$  is the slope ( $p = \partial f / \partial x$ ):

$$g(p) = \min_x \{f(x) - xp\}. \quad (6.72)$$

We saw in the text that in thermodynamics the Legendre transform of the energy is the Helmholtz free energy<sup>57</sup>

$$A(T, N, V) = \min_E \{E(S, V, N) - TS\}. \quad (6.73)$$

Can we connect this with the statistical mechanical relation of Exercise 6.5, which related  $\Omega = \exp(S/k_B)$  to  $Z = \exp(-A/k_B T)$ ? Thermodynamics, roughly speaking, is statistical mechanics without the fluctuations.

*Using your Laplace transform of Exercise 6.5, find an equation for  $E_{\max}$  where the integrand is maximized. Does this energy equal the energy which minimizes the Legendre transform 6.73? Approximate  $Z(\beta)$  in your Laplace transform by the value of the integrand at this maximum (ignoring the fluctuations). Does it give the Legendre transform relation 6.73?*

(6.8) **Euler.** (Thermodynamics, Chemistry) ②

(a) *Using the fact that the entropy  $S(N, V, E)$  is extensive for large systems, show that*

$$N \left. \frac{\partial S}{\partial N} \right|_{V, E} + V \left. \frac{\partial S}{\partial V} \right|_{N, E} + E \left. \frac{\partial S}{\partial E} \right|_{N, V} = S. \quad (6.74)$$

Show from this that in general

$$S = (E + PV - \mu N)/T \quad (6.75)$$

and hence

$$E = TS - PV + \mu N. \quad (6.76)$$

This is Euler's relation.<sup>58</sup>

(b) *Test this explicitly for the ideal gas. Use the ideal gas entropy (eqn 3.57)*

$$\begin{aligned} S(N, V, E) &= \frac{5}{2} N k_B \\ &+ N k_B \log \left[ \frac{V}{N h^3} \left( \frac{4\pi m E}{3N} \right)^{3/2} \right], \end{aligned} \quad (6.77)$$

<sup>55</sup>Joseph-Louis Lagrange (1736–1813). See [89, section 12, p. 331].

<sup>56</sup>Adrien-Marie Legendre (1752–1833).

<sup>57</sup>Actually, eqn 6.40 in the text had  $E$  as the independent variable. As usual in thermodynamics, we can solve  $S(E, V, N)$  for  $E(S, V, N)$ .

<sup>58</sup>Leonhard Euler (1707–1783). More specifically, it is one of many fundamental relations named after Euler; other Euler relations involve the number of faces, edges, and vertices for a polygonalization of a surface and the polar representation of complex numbers.

to derive formulae for  $T$ ,  $P$ , and  $\mu$  in terms of  $E$ ,  $N$ , and  $V$ , and verify eqn 6.75.

(6.9) **Gibbs–Duhem.** (Thermodynamics, Chemistry) ②

As a state function,  $E$  is supposed to depend only on  $S$ ,  $V$ , and  $N$ . But eqn 6.76 seems to show explicit dependence on  $T$ ,  $P$ , and  $\mu$  as well; how can this be?

Another answer is to consider a small shift of all six variables. We know that  $dE = T dS - P dV + \mu dN$ , but if we shift all six variables in Euler’s equation we get  $dE = T dS - P dV + \mu dN + S dT - V dP + N d\mu$ . This implies the *Gibbs–Duhem relation*

$$0 = S dT - V dP + N d\mu. \quad (6.78)$$

This relation implies that the intensive variables  $T$ ,  $P$ , and  $\mu$  are not all independent; the change in  $\mu$  is determined given a small change in  $T$  and  $P$ .

(a) Write  $\mu$  as a suitable derivative of the Gibbs free energy  $G(T, P, N)$ .

This makes  $\mu$  a function of the three variables  $T$ ,  $P$ , and  $N$ . The Gibbs–Duhem relation says it must be independent of  $N$ .

(b) Argue that changing the number of particles in a large system at fixed temperature and pressure should not change the chemical potential.

(Hint: Doubling the number of particles at fixed  $T$  and  $P$  doubles the size and energy of the system as well.)

The fact that both  $G(T, P, N)$  and  $N$  are extensive means that  $G$  must be proportional to  $N$ . We used this extensivity to prove the Euler relation in Exercise 6.8; we can thus use the Euler relation to write the formula for  $G$  directly.

(c) Use the Euler relation (eqn 6.76) to write a formula for  $G = E - TS + PV$ . Is it indeed proportional to  $N$ ? What about your formula for  $\mu$  from part (a); will it be dependent on  $N$ ?

(6.10) **Clausius–Clapeyron.** (Thermodynamics, Chemistry) ③

Consider the phase diagram in Fig. 6.14. Along an equilibrium phase boundary, the temperatures, pressures, and chemical potentials of the two phases must agree; otherwise a flat interface between the two phases would transmit heat, shift sideways, or leak particles, respectively (violating the assumption of equilibrium).

(a) Apply the Gibbs–Duhem relation 6.78 to both phases, for a small shift by  $\Delta T$  along the phase

boundary. Let  $s_1$ ,  $v_1$ ,  $s_2$ , and  $v_2$  be the molecular entropies and volumes ( $s = S/N$ ,  $v = V/N$  for each phase); derive the Clausius–Clapeyron equation for the slope of the coexistence line on the phase diagram

$$dP/dT = (s_1 - s_2)/(v_1 - v_2). \quad (6.79)$$

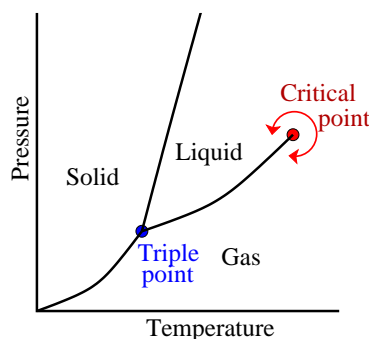


Fig. 6.14 Generic phase diagram, showing the coexistence curves for solids, liquids, and gases.

It is hard to experimentally measure the entropies per particle; we do not have an entropy thermometer. But, as you will remember, the entropy difference upon a phase transformation  $\Delta S = Q/T$  is related to the heat flow  $Q$  needed to induce the phase change. Let the latent heat  $L$  be the heat flow per molecule.

(b) Write a formula for  $dP/dT$  that does not involve the entropy.

(6.11) **Barrier crossing.** (Chemistry) ②

In this exercise, we will derive the Arrhenius law (eqn 6.60)

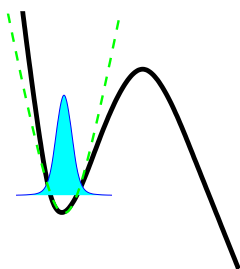
$$\Gamma = \Gamma_0 \exp(-E/k_B T), \quad (6.80)$$

giving the rate at which chemical reactions cross energy barriers. The important exponential dependence on the barrier height  $E$  is the relative Boltzmann probability that a particle is near the top of the barrier (and hence able to escape). Here we will do a relatively careful job of calculating the prefactor  $\Gamma_0$ .

Consider a system having an energy  $U(X)$ , with an energy well with a local minimum at  $X = X_0$  having energy  $U(X_0) = 0$ . Assume there is an energy barrier of height  $U(X_B) = B$  across

which particles can escape.<sup>59</sup> Let the temperature of the system be much smaller than  $B/k_B$ . To do our calculation, we will make some approximations. (1) We assume that the atoms escaping across the barrier to the right do not scatter back into the well. (2) We assume that the atoms deep inside the well are in local equilibrium. (3) We assume that the particles crossing to the right across the barrier are given by the equilibrium distribution inside the well.

(a) Let the probability density that a particle has position  $X$  be  $\rho(X)$ . What is the ratio of probability densities  $\rho(X_B)/\rho(X_0)$  if the particles near the top of the barrier are assumed to be in equilibrium with those deep inside the well? Related formula: Boltzmann distribution  $\rho \propto \exp(-E/k_B T)$ .



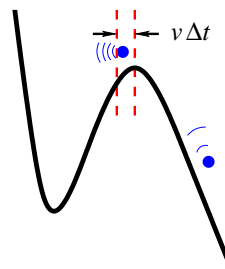
**Fig. 6.15 Well probability distribution.** The approximate probability distribution for the atoms still trapped inside the well.

If the barrier height  $B \gg k_B T$ , then most of the particles in the well stay near the bottom of the well. Often, the potential near the bottom is accurately described by a quadratic approximation  $U(X) \approx \frac{1}{2}M\omega^2(X - X_0)^2$ , where  $M$  is the mass of our system and  $\omega$  is the frequency of small oscillations in the well.

(b) In this approximation, what is the probability density  $\rho(X)$  near the bottom of the well? (See Fig. 6.15.) What is  $\rho(X_0)$ , the probability density of being precisely at the bottom of the well? Related formula: Gaussian probability distribution  $(1/\sqrt{2\pi\sigma^2}) \exp(-x^2/2\sigma^2)$ .

Knowing the answers from (a) and (b), we know the probability density  $\rho(X_B)$  at the top of the

barrier.<sup>60</sup> We also need to know the probability that particles near the top of the barrier have velocity  $V$ , because the faster-moving parts of the distribution of velocities contribute more to the flux of probability over the barrier (see Fig. 6.16). As usual, because the total energy is the sum of the kinetic energy and potential energy, the total Boltzmann probability factors; in equilibrium the particles will always have a velocity probability distribution  $\rho(V) = 1/\sqrt{2\pi k_B T/M} \exp(-\frac{1}{2}MV^2/k_B T)$ .



**Fig. 6.16 Crossing the barrier.** The range of positions for which atoms moving to the right with velocity  $v$  will cross the barrier top in time  $\Delta t$ .

(c) First give a formula for the decay rate  $\Gamma$  (the probability per unit time that a given particle crosses the barrier towards the right), for an unknown probability density  $\rho(X_B)\rho(V)$  as an integral over the velocity  $V$ . Then, using your formulae from parts (a) and (b), give your estimate of the decay rate for our system. Related formula:  $\int_0^\infty x \exp(-x^2/2\sigma^2) dx = \sigma^2$ .

How could we go beyond this one-dimensional calculation? In the olden days, Kramers studied other one-dimensional models, changing the ways in which the system was coupled to the external bath. On the computer, one can avoid a separate heat bath and directly work with the full multidimensional configuration space, leading to *transition-state theory*. The transition-state theory formula is very similar to the one you derived in part (c), except that the prefactor involves the product of all the frequencies at the bottom of the well and all the positive frequencies at the saddlepoint at the top of the

<sup>59</sup>This potential could describe a chemical reaction, with  $X$  being a reaction coordinate. At the other extreme, it could describe the escape of gas from a moon of Jupiter, with  $X$  being the distance from the moon in Jupiter's direction.

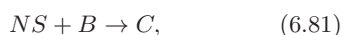
<sup>60</sup>Or rather, we have calculated  $\rho(X_B)$  in equilibrium, half of which (the right movers) we assume will also be crossing the barrier in the non-equilibrium reaction.

barrier (see [55]). Other generalizations arise when crossing multiple barriers [62] or in non-equilibrium systems [83].

(6.12) **Michaelis–Menten and Hill.** (Biology, Computation) ③

Biological reaction rates are often saturable; the cell needs to respond sensitively to the introduction of a new chemical  $S$ , but the response should not keep growing indefinitely as the new chemical concentration  $[S]$  grows.<sup>61</sup> Other biological reactions act as switches; a switch not only saturates, but its rate or state changes sharply from one value to another as the concentration of a chemical  $S$  is varied. These reactions give tangible examples of how one develops effective dynamical theories by removing degrees of freedom; here, instead of coarse-graining some large statistical mechanics system, we remove a single enzyme  $E$  from the equations to get an effective reaction rate.

The rate of a chemical reaction,



where  $N$  substrate molecules  $S$  combine with a  $B$  molecule to make a  $C$  molecule, will occur with a reaction rate given by the law of mass-action:

$$\frac{d[C]}{dt} = k[S]^N[B]. \quad (6.82)$$

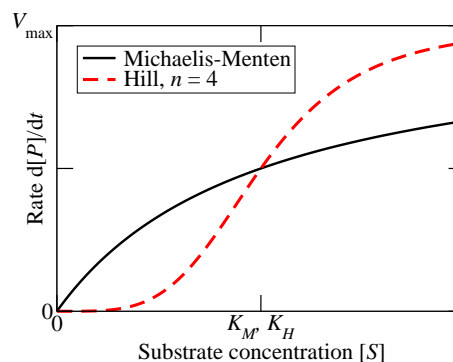
*Saturation and the Michaelis–Menten equation.* Saturation is not seen in ordinary chemical reaction kinetics. Notice that the reaction rate goes as the  $N$ th power of the concentration  $[S]$ ; far from saturating, the reaction rate grows linearly or faster with concentration.

The archetypal example of saturation in biological systems is the *Michaelis–Menten* reaction form. A reaction of this form converting a chemical  $S$  (the substrate) into  $P$  (the product) has a rate given by the formula

$$\frac{d[P]}{dt} = \frac{V_{\max}[S]}{K_M + [S]}, \quad (6.83)$$

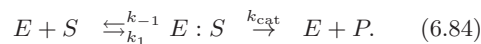
where  $K_M$  is called the Michaelis constant (Fig. 6.17). This reaction at small concentrations acts like an ordinary chemical reaction with  $N = 1$  and  $k = V_{\max}/K_M$ , but the rate saturates at  $V_{\max}$  as  $[S] \rightarrow \infty$ . The Michaelis constant  $K_M$

is the concentration  $[S]$  at which the rate is equal to half of its saturation rate (Fig. 6.17).



**Fig. 6.17 Michaelis–Menten and Hill equation forms.**

We can derive the Michaelis–Menten form by hypothesizing the existence of a catalyst or enzyme  $E$ , which is in short supply. The enzyme is presumed to be partly free and available for binding (concentration  $[E]$ ) and partly bound to the substrate (concentration  $[E : S]$ ), helping it to turn into the product. The total concentration  $[E] + [E : S] = E_{\text{tot}}$  is fixed. The reactions are as follows:



We must then assume that the supply of substrate is large, so its concentration changes slowly with time. We can then assume that the concentration  $[E : S]$  is in steady state, and remove it as a degree of freedom.

(a) Assume the binding reaction rates in eqn 6.84 are of traditional chemical kinetics form (eqn 6.82), with constants  $k_1$ ,  $k_{-1}$ , and  $k_{\text{cat}}$ , and with  $N = 1$  or  $N = 0$  as appropriate. Write the equation for  $d[E : S]/dt$ , set it to zero, and use it to eliminate  $[E]$  in the equation for  $dP/dt$ . What are  $V_{\max}$  and  $K_M$  in the Michaelis–Menten form (eqn 6.83) in terms of the  $k$ s and  $E_{\text{tot}}$ ?

We can understand this saturation intuitively: when all the enzyme is busy and bound to the substrate, adding more substrate cannot speed up the reaction.

*Cooperativity and sharp switching: the Hill equation.* Hemoglobin is what makes blood red;

<sup>61</sup> $[S]$  is the concentration of  $S$  (number per unit volume).  $S$  stands for *substrate*.

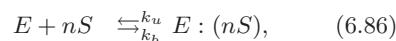
<sup>62</sup>The colon denotes the bound state of the two, called a *dimer*.

this iron-containing protein can bind up to four molecules of oxygen in the lungs, and carries them to the tissues of the body where it releases them. If the binding of all four oxygens were independent, the  $[O_2]$  concentration dependence of the bound oxygen concentration would have the Michaelis–Menten form; to completely deoxygenate the Hemoglobin (Hb) would demand a very low oxygen concentration in the tissue.

What happens instead is that the Hb binding of oxygen looks much more sigmoidal—a fairly sharp transition between nearly four oxygens bound at high  $[O_2]$  (lungs) to nearly none bound at low oxygen concentrations. This arises because the binding of the oxygens is enhanced by having other oxygens bound. This is not because the oxygens somehow stick to one another; instead, each oxygen deforms the Hb in a non-local *allosteric*<sup>63</sup> fashion, changing the configurations and affinity of the other binding sites. The Hill equation was introduced for hemoglobin to describe this kind of cooperative binding. Like the Michaelis–Menten form, it is also used to describe reaction rates, where instead of the carrier Hb we have an enzyme, or perhaps a series of transcription binding sites (see Exercise 8.11). We will derive the Hill equation not in terms of allosteric binding, but in the context of a saturable reaction involving  $n$  molecules binding simultaneously. As a reaction rate, the Hill equation is

$$\frac{d[P]}{dt} = \frac{V_{\max}[S]^n}{K_H^n + [S]^n} \quad (6.85)$$

(see Fig. 6.17). For Hb, the concentration of the  $n$ -fold oxygenated form is given by the right-hand side of eqn 6.85. In both cases, the transition becomes much more of a switch, with the reaction turning on (or the Hb accepting or releasing its oxygen) sharply at a particular concentration (Fig. 6.17). The transition can be made more or less sharp by increasing or decreasing  $n$ . The Hill equation can be derived using a simplifying assumption that  $n$  molecules bind in a single reaction:



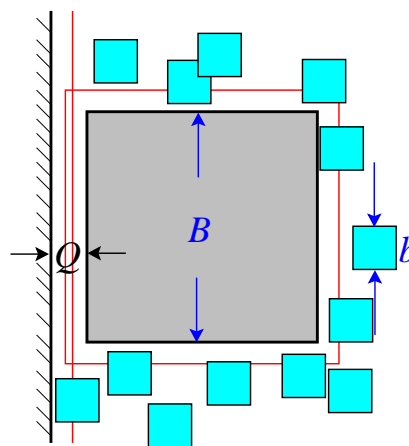
where E might stand for hemoglobin and S for the  $O_2$  oxygen molecules. Again, there is a fixed total amount  $E_{\text{tot}} = [E] + [E : nS]$ .

(b) Assume that the two reactions in eqn 6.86 have the chemical kinetics form (eqn 6.82) with  $N = 0$  or  $N = n$  as appropriate. Write the equilibrium equation for  $E : (nS)$ , and eliminate  $[E]$  using the fixed total  $E_{\text{tot}}$ . What are  $V_{\max}$  and  $K_H$  in terms of  $k_b$ ,  $k_u$ , and  $E_{\text{tot}}$ ?

Usually, and in particular for hemoglobin, this cooperativity is not so rigid; the states with one, two, and three  $O_2$  molecules bound also compete with the unbound and fully bound states. This is treated in an approximate way by using the Hill equation, but allowing  $n$  to vary as a fitting parameter; for Hb,  $n \approx 2.8$ .

Both Hill and Michaelis–Menten equations are often used in biological reaction models even when there are no explicit mechanisms (enzymes, cooperative binding) known to generate them.

(6.13) **Pollen and hard squares.** ③



**Fig. 6.18 Square pollen** grain in fluid of oriented square molecules, next to a wall. The thin lines represent the exclusion region around the pollen grain and away from the wall.

Objects embedded in a gas will have an effective attractive force at short distances, when the gas molecules can no longer fit between the objects. One can view this as a pressure imbalance (no collisions from one side) or as an entropic attraction.

Let us model the entropic attraction between a pollen grain and a wall using a two-dimensional ideal gas of classical indistinguishable particles

<sup>63</sup>Allosteric comes from *Allo* (other) and *steric* (structure or space). Allosteric interactions can be cooperative, as in hemoglobin, or inhibitory.



as the fluid. For convenience, we imagine that the pollen grain and the fluid are formed from square particles lined up with the axes of the box, of lengths  $B$  and  $b$ , respectively (Fig. 6.18). We assume *no interaction* between the ideal gas molecules (unlike in Exercise 3.5), but the potential energy is infinite if the gas molecules overlap with the pollen grain or with the wall. The container as a whole has one pollen grain,  $N$  gas molecules, and total area  $L \times L$ .

Assume the pollen grain is close to only one wall. Let the distance from the surface of the wall to the closest face of the pollen grain be  $Q$ . (A similar square-particle problem with interacting small molecules is studied in [44].)

(a) What is the area  $A(Q \gg 0)$  available for the gas molecules, in units of  $(\text{length})^2$ , when the pollen grain is far from the wall? What is the overlap of the excluded regions,  $A(0) - A(\infty)$ , when the pollen grain touches the wall,  $Q = 0$ ? Give formulae for  $A(Q)$  as a function of  $Q$  for the two relevant regions,  $Q < b$  and  $Q > b$ .

(b) What is the configuration-space volume  $\Omega(Q)$  for the gas, in units of  $(\text{length})^{2N}$ ? What is the configurational entropy of the ideal gas,  $S(Q)$ ? (Write your answers here in terms of  $A(Q)$ .)

Your answers to part (b) can be viewed as giving a free energy for the pollen grain after integrating over the gas degrees of freedom (also known as a partial trace, or coarse-grained free energy).

(c) What is the resulting coarse-grained free energy of the pollen grain,  $\mathcal{F}(Q) = E - TS(Q)$ , in the two regions  $Q > b$  and  $Q < b$ ? Use  $\mathcal{F}(Q)$  to calculate the force on the pollen grain for  $Q < b$ . Is the force positive (away from the wall) or negative? Why?

(d) Directly calculate the force due to the ideal gas pressure on the far side of the pollen grain, in terms of  $A(Q)$ . Compare it to the force from the partial trace in part (c). Why is there no balancing force from the other side? Effectively how 'long' is the far side of the pollen grain?

#### (6.14) Statistical mechanics and statistics.<sup>64</sup>

(Statistics) ③

Consider the problem of fitting a theoretical model to experimentally determined data. Let our model  $M$  predict a time-dependent function  $y^{(M)}(t)$ . Let there be  $N$  experimentally determined data points  $y_i$  at times  $t_i$  with errors of standard deviation  $\sigma$ . We assume that the ex-

perimental errors for the data points are independent and Gaussian distributed, so that the probability that a given model produced the observed data points (the probability  $P(D|M)$  of the data given the model) is

$$P(D|M) = \prod_{i=1}^N \frac{1}{\sqrt{2\pi}\sigma} e^{-(y^{(M)}(t_i) - y_i)^2 / 2\sigma^2}. \quad (6.87)$$

(a) True or false: This probability density corresponds to a Boltzmann distribution with energy  $H$  and temperature  $T$ , with  $H = \sum_{i=1}^N (y^{(M)}(t_i) - y_i)^2 / 2$  and  $k_B T = \sigma^2$ .

There are two approaches to statistics. Among a family of models, the *frequentists* will pick the model  $M$  with the largest value of  $P(D|M)$  (the *maximum likelihood estimate*); the ensemble of best-fit models is then deduced from the range of likely input data (deduced from the error bars  $\sigma$ ). The *Bayesians* take a different point of view. They argue that there is no reason to believe a priori that all models have the same probability. (There is no analogue of Liouville's theorem (Chapter 4) in model space.) Suppose the probability of the model (the *prior*) is  $P(M)$ . They use the theorem

$$P(M|D) = P(D|M)P(M)/P(D). \quad (6.88)$$

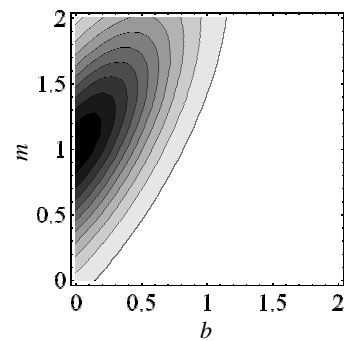
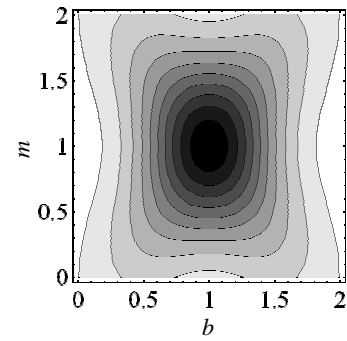
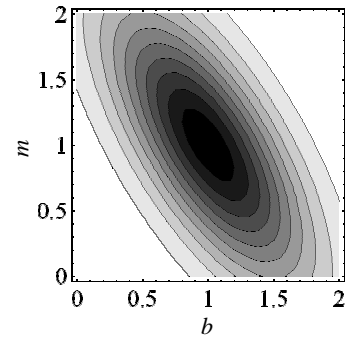
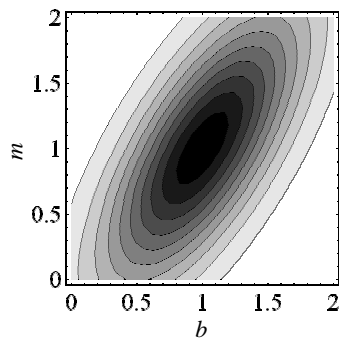
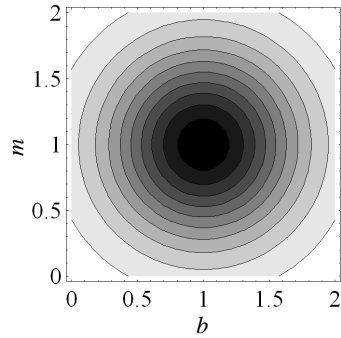
(b) Prove Bayes' theorem (eqn 6.88) using the fact that  $P(A \text{ and } B) = P(A|B)P(B)$  (see note 38 on p. 89).

The Bayesians will often pick the maximum of  $P(M|D)$  as their model for the experimental data. But, given their perspective, it is even more natural to consider the entire *ensemble* of models, weighted by  $P(M|D)$ , as the best description of the data. This ensemble average then naturally provides error bars as well as predictions for various quantities.

Consider the problem of fitting a line to two data points. Suppose the experimental data points are at  $t_1 = 0$ ,  $y_1 = 1$  and  $t_2 = 1$ ,  $y_2 = 2$ , where both  $y$ -values have uncorrelated Gaussian errors with standard deviation  $\sigma = 1/2$ , as assumed in eqn 6.87 above. Our model  $M(m, b)$  is  $y(t) = mt + b$ . Our Bayesian statistician has prior knowledge that  $m$  and  $b$  both lie between zero and two, and assumes that the probability density is otherwise uniform;  $P(m, b) = 1/4$  for  $0 < m < 2$  and  $0 < b < 2$ .

<sup>64</sup>This exercise was developed with the help of Robert Weiss.

(c) Which of the contour plots below accurately represent the probability distribution  $P(M|D)$  for the model, given the observed data? (The spacing between the contour lines is arbitrary.)



# Quantum statistical mechanics



Quantum statistical mechanics governs most of solid-state physics (metals, semiconductors, and glasses) and parts of molecular physics and astrophysics (white dwarfs, neutron stars). It spawned the origin of quantum mechanics (Planck's theory of the black-body spectrum) and provides the framework for our understanding of other exotic quantum phenomena (Bose condensation, superfluids, and superconductors). Applications of quantum statistical mechanics are significant components of courses in these various subjects. We condense our treatment of this important subject into this one chapter in order to avoid overlap with other physics and chemistry courses, and also in order to keep our treatment otherwise accessible to those uninitiated into the quantum mysteries.

In this chapter, we assume the reader has some background in quantum mechanics. We will proceed from the abstract to the concrete, through a series of simplifications. We begin (Section 7.1) by introducing *mixed states* for quantum ensembles, and the advanced topic of *density matrices* (for non-equilibrium quantum systems which are not mixtures of energy eigenstates). We illustrate mixed states in Section 7.2 by solving the finite-temperature quantum harmonic oscillator. We discuss the statistical mechanics of identical particles (Section 7.3). We then make the vast simplification of presuming that the particles are non-interacting (Section 7.4), which leads us to the Bose–Einstein and Fermi distributions for the filling of single-particle eigenstates. We contrast Bose, Fermi, and Maxwell–Boltzmann statistics in Section 7.5. We illustrate how amazingly useful the non-interacting particle picture is for quantum systems by solving the classic problems of black-body radiation and Bose condensation (Section 7.6), and for the behavior of metals (Section 7.7).

7.1 Mixed states and density matrices	135
7.2 Quantum harmonic oscillator	139
7.3 Bose and Fermi statistics	140
7.4 Non-interacting bosons and fermions	141
7.5 Maxwell–Boltzmann ‘quantum’ statistics	144
7.6 Black-body radiation and Bose condensation	146
7.7 Metals and the Fermi gas	150

## 7.1 Mixed states and density matrices

Classical statistical ensembles are probability distributions  $\rho(\mathbb{P}, \mathbb{Q})$  in phase space. How do we generalize them to quantum mechanics? Two problems immediately arise. First, the Heisenberg uncertainty principle tells us that one cannot specify both position and momentum for a quantum system at the same time. The states of our quantum system will not be points in phase space. Second, quantum mechanics

<sup>1</sup>Quantum systems with many particles have wavefunctions that are functions of all the positions of all the particles (or, in momentum space, all the momenta of all the particles).

<sup>2</sup>So, for example, if  $|V\rangle$  is a vertically polarized photon, and  $|H\rangle$  is a horizontally polarized photon, then the superposition  $(1/\sqrt{2})(|V\rangle + |H\rangle)$  is a diagonally polarized photon, while the unpolarized photon is a mixture of half  $|V\rangle$  and half  $|H\rangle$ , described by the density matrix  $\frac{1}{2}(|V\rangle\langle V| + |H\rangle\langle H|)$ . The superposition is in *both* states, the mixture is in *perhaps* one or perhaps the other (see Exercise 7.5).

already has probability densities; even for systems in a definite state<sup>1</sup>  $\Psi(\mathbb{Q})$  the probability is spread among different configurations  $|\Psi(\mathbb{Q})|^2$  (or momenta  $|\tilde{\Psi}(\mathbb{P})|^2$ ). In statistical mechanics, we need to introduce a second level of probability, to discuss an ensemble that has probabilities  $p_n$  of being in a variety of quantum states  $\Psi_n(\mathbb{Q})$ . Ensembles in quantum mechanics are called *mixed states*; they are not superpositions of different wavefunctions, but incoherent mixtures.<sup>2</sup>

Suppose we want to compute the ensemble expectation of an operator  $\mathbf{A}$ . In a particular state  $\Psi_n$ , the quantum expectation is

$$\langle \mathbf{A} \rangle_{\text{pure}} = \int \Psi_n^*(\mathbb{Q}) \mathbf{A} \Psi_n(\mathbb{Q}) d^{3N} \mathbb{Q}. \tag{7.1}$$

So, in the ensemble the expectation is

$$\langle \mathbf{A} \rangle = \sum_n p_n \int \Psi_n^*(\mathbb{Q}) \mathbf{A} \Psi_n(\mathbb{Q}) d^{3N} \mathbb{Q}. \tag{7.2}$$

Except for selected exercises, for the rest of the book we will use mixtures of states (eqn 7.2). Indeed, for all of the equilibrium ensembles, the  $\Psi_n$  may be taken to be the energy eigenstates, and the  $p_n$  either a constant in a small energy range (for the microcanonical ensemble), or  $\exp(-\beta E_n)/Z$  (for the canonical ensemble), or  $\exp(-\beta(E_n - N_n \mu))/\Xi$  (for the grand canonical ensemble). For most practical purposes you may stop reading this section here, and proceed to the quantum harmonic oscillator.

### 7.1.1 Advanced topic: density matrices.

What do we gain from going beyond mixed states? First, there are lots of systems that cannot be described as mixtures of energy eigenstates. (For example, any such mixed state will have time independent properties.) Second, although one can define a general, time-dependent ensemble in terms of more general bases  $\Psi_n$ , it is useful to be able to transform between a variety of bases. Indeed, superfluids and superconductors show an exotic *off-diagonal long-range order* when looked at in position space (Exercise 9.8). Third, we will see that the proper generalization of Liouville’s theorem demands the more elegant, operator-based approach.

Our goal is to avoid carrying around the particular states  $\Psi_n$ . Instead, we will write the ensemble average (eqn 7.2) in terms of  $\mathbf{A}$  and an operator  $\rho$ , the *density matrix*. For this section, it is convenient to use Dirac’s bra-ket notation, in which the mixed-state ensemble average can be written<sup>3</sup>

$$\langle \mathbf{A} \rangle = \sum_n p_n \langle \Psi_n | \mathbf{A} | \Psi_n \rangle. \tag{7.3}$$

Pick any complete orthonormal basis  $\Phi_\alpha$ . Then the identity operator is

$$\mathbf{1} = \sum_\alpha |\Phi_\alpha\rangle\langle\Phi_\alpha| \tag{7.4}$$

<sup>3</sup>In Dirac’s notation,  $\langle \Psi | \mathbf{M} | \Phi \rangle = \int \Psi^* \mathbf{M} \Phi$ .

and, substituting the identity (eqn 7.4) into eqn 7.3 we find

$$\begin{aligned}\langle \mathbf{A} \rangle &= \sum_n p_n \langle \Psi_n | \left( \sum_\alpha |\Phi_\alpha\rangle \langle \Phi_\alpha| \right) \mathbf{A} | \Psi_n \rangle \\ &= \sum_n p_n \sum_\alpha \langle \Phi_\alpha | \mathbf{A} \Psi_n \rangle \langle \Psi_n | \Phi_\alpha \rangle \\ &= \sum_\alpha \langle \Phi_\alpha | \mathbf{A} \left( \sum_n p_n |\Psi_n\rangle \langle \Psi_n| \right) | \Phi_\alpha \rangle \\ &= \text{Tr}(\mathbf{A}\rho),\end{aligned}\tag{7.5}$$

where<sup>4</sup>

$$\rho = \left( \sum_n p_n |\Psi_n\rangle \langle \Psi_n| \right)\tag{7.6}$$

is the *density matrix*.

There are several properties we can now deduce about the density matrix.

**Sufficiency.** In quantum mechanics, all measurement processes involve expectation values of operators. Our density matrix therefore suffices to embody everything we need to know about our quantum system.

**Pure states.** A pure state, with a definite wavefunction  $\Phi$ , has  $\rho_{\text{pure}} = |\Phi\rangle\langle\Phi|$ . In the position basis  $|\mathbb{Q}\rangle$ , this pure-state density matrix has matrix elements  $\rho_{\text{pure}}(\mathbb{Q}, \mathbb{Q}') = \langle \mathbb{Q} | \rho_{\text{pure}} | \mathbb{Q}' \rangle = \Phi^*(\mathbb{Q}')\Phi(\mathbb{Q})$ . Thus in particular we can reconstruct<sup>5</sup> the wavefunction from a pure-state density matrix, up to an overall physically unmeasurable phase. Since our wavefunction is normalized  $\langle\Phi|\Phi\rangle = 1$ , we note also that the square of the density matrix for a pure state equals itself:  $\rho_{\text{pure}}^2 = |\Phi\rangle\langle\Phi||\Phi\rangle\langle\Phi| = |\Phi\rangle\langle\Phi| = \rho_{\text{pure}}$ .

**Normalization.** The trace of a pure-state density matrix  $\text{Tr}\rho_{\text{pure}} = 1$ , since we can pick an orthonormal basis with our wavefunction  $\Phi$  as the first basis element, making the first term in the trace sum one and the others zero. The trace of a general density matrix is hence also one, since it is a probability distribution of pure-state density matrices:

$$\text{Tr}\rho = \text{Tr} \left( \sum_n p_n |\Psi_n\rangle \langle \Psi_n| \right) = \sum_n p_n \text{Tr} (|\Psi_n\rangle \langle \Psi_n|) = \sum_n p_n = 1.\tag{7.8}$$

**Canonical distribution.** The canonical distribution is a mixture of the energy eigenstates  $|E_n\rangle$  with Boltzmann weights  $\exp(-\beta E_n)$ . Hence the density matrix  $\rho_{\text{canon}}$  is diagonal in the energy basis:<sup>6</sup>

$$\rho_{\text{canon}} = \sum_n \frac{\exp(-\beta E_n)}{Z} |E_n\rangle \langle E_n|.\tag{7.9}$$

We can write the canonical density matrix in a basis-independent form using the Hamiltonian operator  $\mathcal{H}$ . First, the partition function is given<sup>7</sup>

<sup>4</sup>The trace of a matrix is the sum of its diagonal elements, and is independent of what basis you write it in. The same is true of operators; we are summing the diagonal elements  $\text{Tr}(M) = \sum_\alpha \langle \Phi_\alpha | M | \Phi_\alpha \rangle$ .

<sup>5</sup>In particular, since  $\Phi$  is normalized  $|\Phi^*(\mathbb{Q}')|^2 = \int d\mathbb{Q} |\rho(\mathbb{Q}, \mathbb{Q}')|^2$  and thus

$$\Phi(\mathbb{Q}) = \frac{\rho(\mathbb{Q}, \mathbb{Q}')}{\sqrt{\int d\tilde{\mathbb{Q}} |\rho(\tilde{\mathbb{Q}}, \mathbb{Q}')|^2}}\tag{7.7}$$

up to the single phase  $\phi^*(\mathbb{Q}')$  for any point  $\mathbb{Q}'$ .

<sup>6</sup>Notice that the states  $\Psi_n$  in a general mixture need not be eigenstates or even orthogonal.

<sup>7</sup>What is the exponential of a matrix  $M$ ? We can define it in terms of a power series,  $\exp(M) = \mathbf{1} + M + M^2/2! + M^3/3! + \dots$ , but it is usually easier to change basis to diagonalize  $M$ . In that basis, any function  $f(M)$  is given by

$$f(\rho) = \begin{pmatrix} f(\rho_{11}) & 0 & 0 & \dots \\ 0 & f(\rho_{22}) & 0 & \dots \\ \dots & \dots & \dots & \dots \end{pmatrix}.\tag{7.10}$$

At the end, change back to the original basis. This procedure also defines  $\log M$  (eqn 7.14).

by the trace

$$Z = \sum_n \exp(-\beta E_n) = \sum_n \langle E_n | \exp(-\beta \mathcal{H}) | E_n \rangle = \text{Tr}(\exp(-\beta \mathcal{H})). \tag{7.11}$$

Second, the numerator

$$\sum_n |E_n\rangle \exp(-\beta E_n) \langle E_n| = \exp(-\beta \mathcal{H}), \tag{7.12}$$

since  $\mathcal{H}$  (and thus  $\exp(-\beta \mathcal{H})$ ) is diagonal in the energy basis. Hence

$$\rho_{\text{canon}} = \frac{\exp(-\beta \mathcal{H})}{\text{Tr}(\exp(-\beta \mathcal{H}))}. \tag{7.13}$$

**Entropy.** The entropy for a general density matrix will be

$$S = -k_B \text{Tr}(\rho \log \rho). \tag{7.14}$$

**Time evolution for the density matrix.** The time evolution for the density matrix is determined by the time evolution of the pure states composing it:<sup>8</sup>

$$\frac{\partial \rho}{\partial t} = \sum_n p_n \left( \frac{\partial |\Psi_n\rangle}{\partial t} \langle \Psi_n| + |\Psi_n\rangle \frac{\partial \langle \Psi_n|}{\partial t} \right). \tag{7.15}$$

Now, the time evolution of the ‘ket’ wavefunction  $|\Psi_n\rangle$  is given by operating on it with the Hamiltonian:

$$\frac{\partial |\Psi_n\rangle}{\partial t} = \frac{1}{i\hbar} \mathcal{H} |\Psi_n\rangle, \tag{7.16}$$

and the time evolution of the ‘bra’ wavefunction  $\langle \Psi_n|$  is given by the time evolution of  $\Psi_n^*(Q)$ :

$$\frac{\partial \Psi_n^*}{\partial t} = \left( \frac{\partial \Psi_n}{\partial t} \right)^* = \left( \frac{1}{i\hbar} \mathcal{H} \Psi_n \right)^* = -\frac{1}{i\hbar} \mathcal{H} \Psi_n^*, \tag{7.17}$$

so since  $\mathcal{H}$  is Hermitian, we have

$$\frac{\partial \langle \Psi_n|}{\partial t} = -\frac{1}{i\hbar} \langle \Psi_n| \mathcal{H}. \tag{7.18}$$

Hence<sup>9</sup>

$$\begin{aligned} \frac{\partial \rho}{\partial t} &= \sum_n p_n \frac{1}{i\hbar} \left( \mathcal{H} |\Psi_n\rangle \langle \Psi_n| - |\Psi_n\rangle \langle \Psi_n| \mathcal{H} \right) = \frac{1}{i\hbar} (\mathcal{H} \rho - \rho \mathcal{H}) \\ &= \frac{1}{i\hbar} [\mathcal{H}, \rho]. \end{aligned} \tag{7.19}$$

**Quantum Liouville theorem.** This time evolution law 7.19 is the quantum version of Liouville’s theorem. We can see this by using the equations of motion 4.1,  $\dot{q}_\alpha = \partial \mathcal{H} / \partial p_\alpha$ , and  $\dot{p}_\alpha = -\partial \mathcal{H} / \partial q_\alpha$  and the definition of Poisson brackets

$$\{A, B\}_P = \sum_\alpha \frac{\partial A}{\partial q_\alpha} \frac{\partial B}{\partial p_\alpha} - \frac{\partial A}{\partial p_\alpha} \frac{\partial B}{\partial q_\alpha} \tag{7.20}$$

<sup>8</sup>The  $p_n$  are the probability that one started in the state  $\Psi_n$ , and thus manifestly do not change with time.

<sup>9</sup>The commutator of two matrices  $[A, B] = AB - BA$ . Notice that eqn 7.19 is minus the formula one uses for the time evolution of operators in the Heisenberg representation.

to rewrite Liouville's theorem that the total time derivative is zero (eqn 4.7) into a statement about the partial time derivative:

$$\begin{aligned} 0 &= \frac{d\rho}{dt} = \frac{\partial\rho}{\partial t} + \sum_{\alpha} \frac{\partial\rho}{\partial q_{\alpha}} \dot{q}_{\alpha} + \frac{\partial\rho}{\partial p_{\alpha}} \dot{p}_{\alpha} \\ &= \frac{\partial\rho}{\partial t} + \sum_{\alpha} \left( \frac{\partial\rho}{\partial q_{\alpha}} \frac{\partial\mathcal{H}}{\partial p_{\alpha}} - \frac{\partial\rho}{\partial p_{\alpha}} \frac{\partial\mathcal{H}}{\partial q_{\alpha}} \right), \end{aligned} \quad (7.21)$$

so

$$\frac{\partial\rho}{\partial t} = \{\mathcal{H}, \rho\}_P. \quad (7.22)$$

Using the classical $\leftrightarrow$ quantum correspondence between the Poisson brackets and the commutator  $\{ \}_P \leftrightarrow (1/i\hbar)[ \ ]$  the time evolution law 7.19 is precisely the analogue of Liouville's theorem 7.22.

**Quantum Liouville and statistical mechanics.** The classical version of Liouville's equation is far more compelling an argument for statistical mechanics than is the quantum version. The classical theorem, you remember, states that  $d\rho/dt = 0$ ; the density following a point on the trajectory is constant, hence any time-independent density must have  $\rho$  constant along the trajectories. If the trajectory covers the energy surface (ergodicity), then the probability density has to be constant on the energy surface, justifying the microcanonical ensemble.

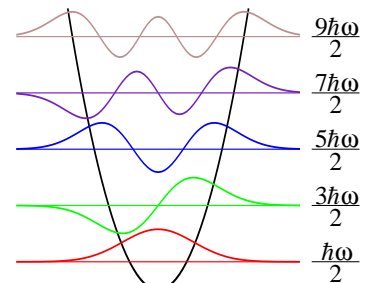
For an isolated quantum system, this argument breaks down. The condition that an equilibrium state must be time independent is not very stringent. Indeed,  $\partial\rho/\partial t = [\mathcal{H}, \rho] = 0$  for any mixture of many-body energy eigenstates. In principle, isolated quantum systems are very non-ergodic, and one must couple them to the outside world to induce transitions between the many-body eigenstates needed for equilibration.<sup>10</sup>

## 7.2 Quantum harmonic oscillator

The harmonic oscillator is a great example of how statistical mechanics works in quantum systems. Consider an oscillator of frequency  $\omega$ . The energy eigenvalues are  $E_n = (n + 1/2)\hbar\omega$  (Fig. 7.1). Hence its partition function is a geometric series  $\sum x^n$ , which we can sum to  $1/(1-x)$ :

$$\begin{aligned} Z_{\text{qho}} &= \sum_{n=0}^{\infty} e^{-\beta E_n} = \sum_{n=0}^{\infty} e^{-\beta\hbar\omega(n+1/2)} \\ &= e^{-\beta\hbar\omega/2} \sum_{n=0}^{\infty} (e^{-\beta\hbar\omega})^n = e^{-\beta\hbar\omega/2} \frac{1}{1 - e^{-\beta\hbar\omega}} \\ &= \frac{1}{e^{\beta\hbar\omega/2} - e^{-\beta\hbar\omega/2}} = \frac{1}{2 \sinh(\beta\hbar\omega/2)}. \end{aligned} \quad (7.23)$$

<sup>10</sup>This may seem less of a concern when one realizes just how peculiar a many-body eigenstate of a large system really is. Consider an atom in an excited state contained in a large box. We normally think of the atom as being in an energy eigenstate, which decays after some time into a ground state atom plus some photons. Clearly, the atom was only in an approximate eigenstate (or it would not decay); it is in a *resonance* that is an eigenstate if we ignore the coupling to the electromagnetic field. The true many-body eigenstates of the system are weird delicate superpositions of states with photons being absorbed by the atom and the atom emitting photons, carefully crafted to produce a stationary state. When one starts including more atoms and other interactions, the true many-body eigenstates are usually pretty useless (apart from the ground state and the lowest excitations). Tiny interactions with the outside world disrupt these many-body eigenstates, and usually lead efficiently to equilibrium.



**Fig. 7.1** The quantum states of the harmonic oscillator are at equally-spaced energies.

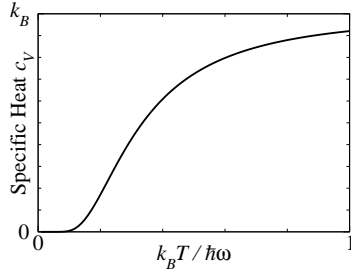


Fig. 7.2 The specific heat for the quantum harmonic oscillator.

<sup>11</sup>We call it the energy gap in solid-state physics; it is the minimum energy needed to add an excitation to the system. In quantum field theory, where the excitations are particles, we call it the *mass* of the particle  $mc^2$ .

<sup>12</sup>In three dimensions, this phase change must be  $\pm 1$ . In two dimensions one can have any phase change, so one can have not only fermions and bosons but *anyons*. Anyons, with fractional statistics, arise as excitations in the fractional quantized Hall effect.

<sup>13</sup>Examples of bosons include mesons,  $\text{He}^4$ , phonons, photons, gluons,  $W^\pm$  and  $Z$  bosons, and (presumably) gravitons. The last four mediate the fundamental forces—the electromagnetic, strong, weak, and gravitational interactions. The spin-statistics theorem (not discussed here) states that bosons have integer spins.

<sup>14</sup>Most of the common elementary particles are fermions: electrons, protons, neutrons, neutrinos, quarks, *etc.* Fermions have half-integer spins. Particles made up of even numbers of fermions are bosons.

<sup>15</sup>A permutation  $\{P_1, P_2, \dots, P_N\}$  is just a reordering of the integers  $\{1, 2, \dots, N\}$ . The sign  $\sigma(P)$  of a permutation is  $+1$  if  $P$  is an even permutation, and  $-1$  if  $P$  is an odd permutation. Swapping two labels, keeping all the rest unchanged, is an odd permutation. One can show that composing two permutations multiplies their signs, so odd permutations can be made by odd numbers of pair swaps, and even permutations are composed of even numbers of pair swaps.

The average energy is

$$\begin{aligned} \langle E \rangle_{\text{qho}} &= -\frac{\partial \log Z_{\text{qho}}}{\partial \beta} = \frac{\partial}{\partial \beta} \left[ \frac{1}{2} \beta \hbar \omega + \log(1 - e^{-\beta \hbar \omega}) \right] \\ &= \hbar \omega \left( \frac{1}{2} + \frac{e^{-\beta \hbar \omega}}{1 - e^{-\beta \hbar \omega}} \right) = \hbar \omega \left( \frac{1}{2} + \frac{1}{e^{\beta \hbar \omega} - 1} \right), \end{aligned} \quad (7.24)$$

which corresponds to an average excitation level

$$\langle n \rangle_{\text{qho}} = \frac{1}{e^{\beta \hbar \omega} - 1}. \quad (7.25)$$

The specific heat is thus

$$c_V = \frac{\partial E}{\partial T} = k_B \left( \frac{\hbar \omega}{k_B T} \right)^2 \frac{e^{-\hbar \omega / k_B T}}{(1 - e^{-\hbar \omega / k_B T})^2} \quad (7.26)$$

(Fig. 7.2). At high temperatures,  $e^{-\hbar \omega / k_B T} \approx 1 - \hbar \omega / k_B T$ , so  $c_V \rightarrow k_B$  as we found for the classical harmonic oscillator (and as given by the equipartition theorem). At low temperatures,  $e^{-\hbar \omega / k_B T}$  becomes exponentially small, so the specific heat goes rapidly to zero as the energy asymptotes to the zero-point energy  $\frac{1}{2} \hbar \omega$ . More specifically, there is an energy gap<sup>11</sup>  $\hbar \omega$  to the first excitation, so the probability of having any excitation of the system is suppressed by a factor of  $e^{-\hbar \omega / k_B T}$ .

### 7.3 Bose and Fermi statistics

In quantum mechanics, identical particles are not just hard to tell apart—their quantum wavefunctions must be the same, up to an overall phase change,<sup>12</sup> when the coordinates are swapped (see Fig. 7.3). In particular, for bosons<sup>13</sup> the wavefunction is unchanged under a swap, so

$$\Psi(\mathbf{r}_1, \mathbf{r}_2, \dots, \mathbf{r}_N) = \Psi(\mathbf{r}_2, \mathbf{r}_1, \dots, \mathbf{r}_N) = \Psi(\mathbf{r}_{P_1}, \mathbf{r}_{P_2}, \dots, \mathbf{r}_{P_N}) \quad (7.27)$$

for any permutation  $P$  of the integers  $1, \dots, N$ . For fermions<sup>14</sup>

$$\Psi(\mathbf{r}_1, \mathbf{r}_2, \dots, \mathbf{r}_N) = -\Psi(\mathbf{r}_2, \mathbf{r}_1, \dots, \mathbf{r}_N) = \sigma(P) \Psi(\mathbf{r}_{P_1}, \mathbf{r}_{P_2}, \dots, \mathbf{r}_{P_N}), \quad (7.28)$$

where  $\sigma(P)$  is the sign of the permutation  $P$ .<sup>15</sup>

The eigenstates for systems of identical fermions and bosons are a subset of the eigenstates of distinguishable particles with the same Hamiltonian:

$$\mathcal{H} \Psi_n = E_n \Psi_n; \quad (7.29)$$

in particular, they are given by the distinguishable eigenstates which obey the proper symmetry properties under permutations. A non-symmetric eigenstate  $\Phi$  with energy  $E$  may be symmetrized to form a Bose eigenstate by summing over all possible permutations  $P$ :

$$\Psi_{\text{sym}}(\mathbf{r}_1, \mathbf{r}_2, \dots, \mathbf{r}_N) = (\text{normalization}) \sum_P \Phi(\mathbf{r}_{P_1}, \mathbf{r}_{P_2}, \dots, \mathbf{r}_{P_N}) \quad (7.30)$$



or antisymmetrized to form a fermion eigenstate

$$\Psi_{\text{asym}}(\mathbf{r}_1, \mathbf{r}_2, \dots, \mathbf{r}_N) = (\text{normalization}) \sum_P \sigma(P) \Phi(\mathbf{r}_{P_1}, \mathbf{r}_{P_2}, \dots, \mathbf{r}_{P_N}) \tag{7.31}$$

if the symmetrization or antisymmetrization does not make the sum zero. These remain eigenstates of energy  $E$ , because they are combinations of eigenstates of energy  $E$ .

Quantum statistical mechanics for identical particles is given by restricting the ensembles to sum over symmetric wavefunctions for bosons or antisymmetric wavefunctions for fermions. So, for example, the partition function for the canonical ensemble is still

$$Z = \text{Tr} (e^{-\beta H}) = \sum_n e^{-\beta E_n}, \tag{7.32}$$

but now the trace is over a complete set of many-body symmetric (or antisymmetric) states, and the sum is over the symmetric (or antisymmetric) many-body energy eigenstates.

### 7.4 Non-interacting bosons and fermions

Many-body quantum statistical mechanics is hard. We now make a huge approximation: we will assume our quantum particles do not interact with one another. Just as for the classical ideal gas, this will make our calculations straightforward.

The non-interacting Hamiltonian is a sum of single-particle quantum Hamiltonians  $H$ :

$$\mathcal{H}^{\text{NI}} = \sum_{j=1}^N H(\mathbf{p}_j, \mathbf{r}_j) = \sum_{j=1}^N \frac{\hbar^2}{2m} \nabla_j^2 + V(\mathbf{r}_j). \tag{7.33}$$

Let  $\psi_k$  be the single-particle eigenstates of  $H$ , then

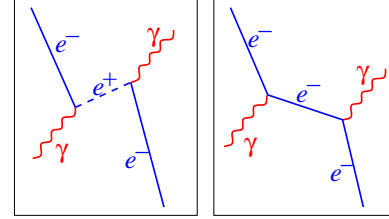
$$H\psi_k(\mathbf{r}) = \varepsilon_k \psi_k(\mathbf{r}). \tag{7.34}$$

For distinguishable particles, the many-body eigenstates can be written as a product of orthonormal single-particle eigenstates:

$$\Psi_{\text{dist}}^{\text{NI}}(\mathbf{r}_1, \mathbf{r}_2, \dots, \mathbf{r}_N) = \prod_{j=1}^N \psi_{k_j}(\mathbf{r}_j), \tag{7.35}$$

where particle  $j$  is in the single-particle eigenstate  $k_j$ . The eigenstates for non-interacting bosons are given by symmetrizing over the coordinates  $r_j$ :

$$\Psi_{\text{boson}}^{\text{NI}}(\mathbf{r}_1, \mathbf{r}_2, \dots, \mathbf{r}_N) = (\text{normalization}) \sum_P \prod_{j=1}^N \psi_{k_j}(\mathbf{r}_{P_j}), \tag{7.36}$$



**Fig. 7.3 Feynman diagram: identical particles.** In quantum mechanics, two electrons (or two atoms of the same isotope) are fundamentally identical. We can illustrate this with a peek at an advanced topic mixing quantum field theory and relativity. Here is a scattering event of a photon off an electron, viewed in two reference frames; time is vertical, a spatial coordinate is horizontal. On the left we see two ‘different’ electrons, one which is created along with an anti-electron or positron  $e^+$ , and the other which later annihilates the positron. On the right we see the same event viewed in a different reference frame; here there is only one electron, which scatters two photons. (The electron is *virtual*, moving faster than light, between the collisions; this is allowed in intermediate states for quantum transitions.) The two electrons on the left are not only indistinguishable, they are the *same particle*! The antiparticle is also the electron, traveling backward in time.

<sup>16</sup>This antisymmetrization can be written as

$$\frac{1}{\sqrt{N!}} \begin{vmatrix} \psi_{k_1}(\mathbf{r}_1) & \dots & \psi_{k_1}(\mathbf{r}_N) \\ \psi_{k_2}(\mathbf{r}_1) & \dots & \psi_{k_2}(\mathbf{r}_N) \\ \dots & \dots & \dots \\ \psi_{k_N}(\mathbf{r}_1) & \dots & \psi_{k_N}(\mathbf{r}_N) \end{vmatrix} \quad (7.37)$$

called the *Slater determinant*.

<sup>17</sup>Notice that the normalization of the boson wavefunction depends on how many single-particle states are multiply occupied.

<sup>18</sup>Because the spin of the electron can be in two directions  $\pm 1/2$ , this means that two electrons can be placed into each single-particle spatial eigenstate.

and naturally the fermion eigenstates are given by antisymmetrizing over all  $N!$  possible permutations, and renormalizing to one,<sup>16</sup>

$$\Psi_{\text{fermion}}^{\text{NI}}(\mathbf{r}_1, \mathbf{r}_2, \dots, \mathbf{r}_N) = \frac{1}{\sqrt{N!}} \sum_P \sigma(P) \prod_{j=1}^N \psi_{k_j}(\mathbf{r}_{P_j}). \quad (7.38)$$

Let us consider two particles in orthonormal single-particle energy eigenstates  $\psi_k$  and  $\psi_\ell$ . If the particles are distinguishable, there are two eigenstates  $\psi_k(\mathbf{r}_1)\psi_\ell(\mathbf{r}_2)$  and  $\psi_k(\mathbf{r}_2)\psi_\ell(\mathbf{r}_1)$ . If the particles are bosons, the eigenstate is  $(1/\sqrt{2})(\psi_k(\mathbf{r}_1)\psi_\ell(\mathbf{r}_2) + \psi_k(\mathbf{r}_2)\psi_\ell(\mathbf{r}_1))$ . If the particles are fermions, the eigenstate is  $(1/\sqrt{2})(\psi_k(\mathbf{r}_1)\psi_\ell(\mathbf{r}_2) - \psi_k(\mathbf{r}_2)\psi_\ell(\mathbf{r}_1))$ .

What if the particles are in the same single-particle eigenstate  $\psi_\ell$ ? For bosons, the eigenstate  $\psi_\ell(\mathbf{r}_1)\psi_\ell(\mathbf{r}_2)$  is already symmetric and normalized.<sup>17</sup> For fermions, antisymmetrizing a state where both particles are in the same state gives zero:  $\psi_\ell(\mathbf{r}_1)\psi_\ell(\mathbf{r}_2) - \psi_\ell(\mathbf{r}_2)\psi_\ell(\mathbf{r}_1) = 0$ . This is the Pauli exclusion principle: you cannot have two fermions in the same quantum state.<sup>18</sup>

How do we do statistical mechanics for non-interacting fermions and bosons? Here it is most convenient to use the grand canonical ensemble (Section 6.3); in this ensemble we can treat each eigenstate as being populated independently from the other eigenstates, exchanging particles directly with the external bath (analogous to Fig. 6.2). The grand partition function hence factors:

$$\Xi^{\text{NI}} = \prod_k \Xi_k. \quad (7.39)$$

The grand canonical ensemble thus allows us to separately solve the case of non-interacting particles one eigenstate at a time.

**Bosons.** For bosons, all fillings  $n_k$  are allowed. Each particle in eigenstate  $\psi_k$  contributes energy  $\varepsilon_k$  and chemical potential  $-\mu$ , so

$$\Xi_k^{\text{boson}} = \sum_{n_k=0}^{\infty} e^{-\beta(\varepsilon_k - \mu)n_k} = \sum_{n_k=0}^{\infty} \left( e^{-\beta(\varepsilon_k - \mu)} \right)^{n_k} = \frac{1}{1 - e^{-\beta(\varepsilon_k - \mu)}} \quad (7.40)$$

and the boson grand partition function is

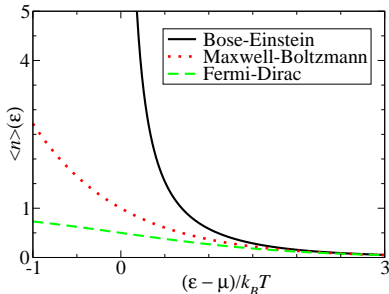
$$\Xi_{\text{boson}}^{\text{NI}} = \prod_k \frac{1}{1 - e^{-\beta(\varepsilon_k - \mu)}}. \quad (7.41)$$

The grand free energy ( $\Phi = -k_B T \log \Xi$ , eqn 6.36) is a sum of single-state grand free energies:

$$\Phi_{\text{boson}}^{\text{NI}} = \sum_k \Phi_k^{\text{boson}} = \sum_k k_B T \log \left( 1 - e^{-\beta(\varepsilon_k - \mu)} \right). \quad (7.42)$$

Because the filling of different states is independent, we can find out the expected number of particles in state  $\psi_k$ . From eqn 6.38,

$$\langle n_k \rangle = -\frac{\partial \Phi_k^{\text{boson}}}{\partial \mu} = -k_B T \frac{-\beta e^{-\beta(\varepsilon_k - \mu)}}{1 - e^{-\beta(\varepsilon_k - \mu)}} = \frac{1}{e^{\beta(\varepsilon_k - \mu)} - 1}. \quad (7.43)$$



**Fig. 7.4** Bose–Einstein, Maxwell–Boltzmann, and Fermi–Dirac distributions,  $\langle n \rangle(\varepsilon)$ . Occupation number for single-particle eigenstates as a function of energy  $\varepsilon$  away from the chemical potential  $\mu$ . The Bose–Einstein distribution diverges as  $\mu$  approaches  $\varepsilon$ ; the Fermi–Dirac distribution saturates at one as  $\mu$  gets small.

This is called the *Bose–Einstein* distribution (Fig. 7.4)

$$\langle n \rangle_{\text{BE}} = \frac{1}{e^{\beta(\varepsilon - \mu)} - 1}. \quad (7.44)$$

The Bose–Einstein distribution describes the filling of single-particle eigenstates by non-interacting bosons. For states with low occupancies, where  $\langle n \rangle \ll 1$ ,  $\langle n \rangle_{\text{BE}} \approx e^{-\beta(\varepsilon - \mu)}$ , and the boson populations correspond to what we would guess naively from the Boltzmann distribution.<sup>19</sup> The condition for low occupancies is  $\varepsilon_k - \mu \gg k_B T$ , which usually arises at high temperatures<sup>20</sup> (where the particles are distributed among a larger number of states). Notice also that  $\langle n \rangle_{\text{BE}} \rightarrow \infty$  as  $\mu \rightarrow \varepsilon_k$  since the denominator vanishes (and becomes negative for  $\mu > \varepsilon_k$ ); systems of non-interacting bosons always have  $\mu$  less than or equal to the lowest of the single-particle energy eigenvalues.<sup>21</sup>

Notice that the average excitation  $\langle n \rangle_{\text{qho}}$  of the quantum harmonic oscillator (eqn 7.25) is given by the Bose–Einstein distribution (eqn 7.44) with  $\mu = 0$ . We will use this in Exercise 7.2 to argue that one can treat excitations inside harmonic oscillators (vibrations) as particles obeying Bose statistics (phonons).

**Fermions.** For fermions, only  $n_k = 0$  and  $n_k = 1$  are allowed. The single-state fermion grand partition function is

$$\Xi_k^{\text{fermion}} = \sum_{n_k=0}^1 e^{-\beta(\varepsilon_k - \mu)n_k} = 1 + e^{-\beta(\varepsilon_k - \mu)}, \quad (7.45)$$

so the total fermion grand partition function is

$$\Xi_{\text{fermion}}^{\text{NI}} = \prod_k \left( 1 + e^{-\beta(\varepsilon_k - \mu)} \right). \quad (7.46)$$

For summing over only two states, it is hardly worthwhile to work through the grand free energy to calculate the expected number of particles in a state:

$$\langle n_k \rangle = \frac{\sum_{n_k=0}^1 n_k \exp(-\beta(\varepsilon_k - \mu)n_k)}{\sum_{n_k=0}^1 \exp(-\beta(\varepsilon_k - \mu)n_k)} = \frac{e^{-\beta(\varepsilon_k - \mu)}}{1 + e^{-\beta(\varepsilon_k - \mu)}} = \frac{1}{e^{\beta(\varepsilon_k - \mu)} + 1}, \quad (7.47)$$

leading us to the *Fermi–Dirac* distribution

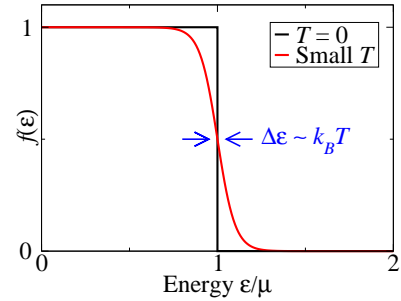
$$f(\varepsilon) = \langle n \rangle_{\text{FD}} = \frac{1}{e^{\beta(\varepsilon - \mu)} + 1}, \quad (7.48)$$

where  $f(\varepsilon)$  is also known as the Fermi function (Fig. 7.5). Again, when the mean occupancy of state  $\psi_k$  is low, it is approximately given by the Boltzmann probability distribution,  $e^{-\beta(\varepsilon - \mu)}$ . Here the chemical potential can be either greater than or less than any given eigenenergy  $\varepsilon_k$ . Indeed, at low temperatures the chemical potential  $\mu$  separates filled states  $\varepsilon_k < \mu$  from empty states  $\varepsilon_k > \mu$ ; only states within roughly  $k_B T$  of  $\mu$  are partially filled.

<sup>19</sup>We will derive this from Maxwell–Boltzmann statistics in Section 7.5.

<sup>20</sup>This may seem at odds with the formula, but as  $T$  gets large  $\mu$  gets large and negative even faster. This happens (at fixed total number of particles) because more states at high temperatures are available for occupation, so the pressure  $\mu$  needed to keep them filled decreases.

<sup>21</sup>Chemical potential is like a pressure pushing atoms into the system. When the river level gets up to the height of the fields, your farm gets flooded.



**Fig. 7.5 The Fermi distribution**  $f(\varepsilon)$  of eqn 7.48. At low temperatures, states below  $\mu$  are occupied, states above  $\mu$  are unoccupied, and states within around  $k_B T$  of  $\mu$  are partially occupied.

The chemical potential  $\mu$  is playing a large role in these calculations. How do you determine it? You normally know the expected number of particles  $N$ , and must vary  $\mu$  until you reach that value. Hence  $\mu$  directly plays the role of a particle pressure from the outside world, which is varied until the system is correctly filled.

**The amazing utility of non-interacting bosons and fermions.**

The classical ideal gas is a great illustration of statistical mechanics, and does a good job of describing many gases, but nobody would suggest that it captures the main features of solids and liquids. The non-interacting approximation in quantum mechanics turns out to be far more powerful, for quite subtle reasons.

For bosons, the non-interacting approximation is quite accurate in three important cases: photons, phonons, and the dilute Bose gas. In Section 7.6 we will study two fundamental problems involving non-interacting bosons: black-body radiation and Bose condensation. The behavior of superconductors and superfluids shares some common features with that of the Bose gas.

For fermions, the non-interacting approximation would rarely seem to be useful. Electrons are charged, and the electromagnetic repulsion between the electrons in an atom, molecule, or material is always a major contribution to the energy. Neutrons interact via the strong interaction, so nuclei and neutron stars are also poor candidates for a non-interacting theory. Neutrinos are hard to pack into a box.<sup>22</sup> There are experiments on cold, dilute gases of fermion atoms, but non-interacting fermions would seem a model with few applications.

The truth is that the non-interacting Fermi gas describes all of these systems (atoms, metals, insulators, nuclei, and neutron stars) remarkably well. Interacting Fermi systems under most common circumstances behave very much like collections of non-interacting fermions in a modified potential. The approximation is so powerful that in most circumstances we ignore the interactions; whenever we talk about exciting a ‘1S electron’ in an oxygen atom, or an ‘electron–hole’ pair in a semiconductor, we are using this effective non-interacting electron approximation. The explanation for this amazing fact is called Landau Fermi-liquid theory.<sup>23</sup>

<sup>22</sup>Just in case you have not heard, neutrinos are quite elusive. A lead wall that can stop half of the neutrinos would be light-years thick.

<sup>23</sup>Landau’s insight was to describe interacting systems of fermions (e.g., electrons) at temperatures low compared to the Fermi energy by starting from the non-interacting Fermi gas and slowly ‘turning on’ the interaction. (The Fermi energy  $\varepsilon_F = \mu(T = 0)$ , see Section 7.7.) Excited states of the non-interacting gas are electrons excited into states above the Fermi energy, leaving holes behind. They evolve in two ways when the interactions are turned on. First, the excited electrons and holes push and pull on the surrounding electron gas, creating a *screening cloud* that *dresses* the bare excitations into *quasiparticles*. Second, these quasiparticles develop lifetimes; they are no longer eigenstates, but *resonances*. Quasiparticles are useful descriptions so long as the interactions can be turned on slowly enough for the screening cloud to form but fast enough so that the quasiparticles have not yet decayed; this occurs for electrons and holes near the Fermi energy, which have long lifetimes because they can only decay into energy states even closer to the Fermi energy [9, p. 345]. Later workers fleshed out Landau’s ideas into a systematic perturbative calculation, where the quasiparticles are poles in a quantum Green’s function (see Exercise 10.9 for a classical example of how this works). More recently, researchers have found a renormalization-group interpretation of Landau’s argument, whose coarse-graining operation removes states far from the Fermi energy, and which flows to an effective non-interacting Fermi gas (see Chapter 12 and Exercise 12.8).

## 7.5 Maxwell–Boltzmann ‘quantum’ statistics

In classical statistical mechanics, we treated indistinguishable particles as distinguishable ones, except that we divided the phase-space volume, (or the partition function, in the canonical ensemble) by a factor of  $N!$ :

$$\begin{aligned}\Omega_N^{\text{MB}} &= \frac{1}{N!} \Omega_N^{\text{dist}}, \\ Z_N^{\text{MB}} &= \frac{1}{N!} Z_N^{\text{dist}}.\end{aligned}\tag{7.49}$$

This was important to get the entropy to be extensive (Section 5.2.1). This approximation is also sometimes used in quantum statistical mechanics, although we should emphasize that it does not describe either bosons, fermions, or any physical system. These bogus particles are said to obey *Maxwell–Boltzmann* statistics.<sup>24</sup>

What is the canonical partition function for the case of  $N$  non-interacting distinguishable quantum particles? If the partition function for one particle is

$$Z_1 = \sum_k e^{-\beta \varepsilon_k} \quad (7.50)$$

then the partition function for  $N$  non-interacting, distinguishable (but otherwise similar) particles is

$$Z_N^{\text{NI,dist}} = \sum_{k_1, k_2, \dots, k_N} e^{-\beta(\varepsilon_{k_1} + \varepsilon_{k_2} + \dots + \varepsilon_{k_N})} = \prod_{j=1}^N \left( \sum_{k_j} e^{-\beta \varepsilon_{k_j}} \right) = Z_1^N. \quad (7.51)$$

So, the Maxwell–Boltzmann partition function for non-interacting particles is

$$Z_N^{\text{NI,MB}} = Z_1^N / N!. \quad (7.52)$$

Let us illustrate the relation between these three distributions by considering the canonical ensemble of two non-interacting particles in three possible states of energies  $\varepsilon_1$ ,  $\varepsilon_2$ , and  $\varepsilon_3$ . The Maxwell–Boltzmann partition function for such a system would be

$$\begin{aligned} Z_2^{\text{NI,MB}} &= \frac{1}{2!} (e^{-\beta \varepsilon_1} + e^{-\beta \varepsilon_2} + e^{-\beta \varepsilon_3})^2 \\ &= \frac{1}{2} e^{-2\beta \varepsilon_1} + \frac{1}{2} e^{-2\beta \varepsilon_2} + \frac{1}{2} e^{-2\beta \varepsilon_3} \\ &\quad + e^{-\beta(\varepsilon_1 + \varepsilon_2)} + e^{-\beta(\varepsilon_1 + \varepsilon_3)} + e^{-\beta(\varepsilon_2 + \varepsilon_3)}. \end{aligned} \quad (7.53)$$

The  $1/N!$  fixes the weights of the singly-occupied states<sup>25</sup> nicely; each has weight one in the Maxwell–Boltzmann partition function. But the doubly-occupied states, where both particles have the same wavefunction, have an unintuitive suppression by  $\frac{1}{2}$  in the sum.

There are basically two ways to fix this. One is to stop discriminating against multiply-occupied states, and to treat them all democratically. This gives us non-interacting bosons:

$$Z_2^{\text{NI,boson}} = e^{-2\beta \varepsilon_1} + e^{-2\beta \varepsilon_2} + e^{-2\beta \varepsilon_3} + e^{-\beta(\varepsilon_1 + \varepsilon_2)} + e^{-\beta(\varepsilon_1 + \varepsilon_3)} + e^{-\beta(\varepsilon_2 + \varepsilon_3)}. \quad (7.54)$$

The other way is to ‘squelch’ multiple occupancy altogether. This leads to fermions:

$$Z_2^{\text{NI,fermion}} = e^{-\beta(\varepsilon_1 + \varepsilon_2)} + e^{-\beta(\varepsilon_1 + \varepsilon_3)} + e^{-\beta(\varepsilon_2 + \varepsilon_3)}. \quad (7.55)$$

Thus the Maxwell–Boltzmann distribution treats multiple occupancy of states in an unphysical compromise between democratic bosons and exclusive fermions.

<sup>24</sup>Sometimes it is said that distinguishable particles obey Maxwell–Boltzmann statistics. Many properties are independent of the  $N!$  in the denominator of eqn 7.49, such as the occupancy  $\langle n \rangle$  of non-interacting single-particle eigenstates (eqn 7.60). But this factor does matter for other properties, like the entropy of mixing and the Helmholtz free energy, so we reserve the term Maxwell–Boltzmann for undistinguished particles (Section 3.5).

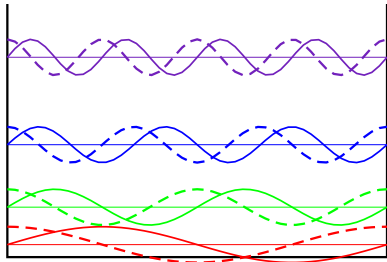
<sup>25</sup>More precisely, we mean those many-body states where the single-particle states are all singly occupied or vacant.

<sup>26</sup>See Exercise 7.1 for more details about the three ensembles and the four types of statistics.

<sup>27</sup>It is amusing to note that non-interacting particles fill single-particle energy states according to the same law

$$\langle n \rangle = \frac{1}{e^{\beta(\varepsilon - \mu)} + c}, \quad (7.59)$$

with  $c = -1$  for bosons,  $c = 1$  for fermions, and  $c = 0$  for Maxwell–Boltzmann statistics.



**Fig. 7.6 Particle in a box.** The quantum states of a particle in a one-dimensional box with periodic boundary conditions are sine and cosine waves  $\psi_n$  with  $n$  wavelengths in the box,  $k_n = 2\pi n/L$ . With a real box (zero boundary conditions at the walls) one would have only sine waves, but at half the spacing between wavevectors  $k_n = \pi n/L$ , giving the same net density of states.

<sup>28</sup>That is, the value of  $\psi$  at the walls need not be zero (as for an infinite square well), but rather must agree on opposite sides, so  $\psi(0, y, z) \equiv \psi(L, y, z)$ ,  $\psi(x, 0, z) \equiv \psi(x, L, z)$ , and  $\psi(x, y, 0) \equiv \psi(x, y, L)$ . Periodic boundary conditions are not usually seen in experiments, but are much more natural to compute with, and the results are unchanged for large systems.

Here we have been comparing the different distributions within the canonical ensemble. What about the grand canonical ensemble, which we actually use for calculations?<sup>26</sup> The grand partition function for Maxwell–Boltzmann statistics is

$$\begin{aligned} \Xi^{\text{NI,MB}} &= \sum_M Z_M^{\text{NI,MB}} e^{M\beta\mu} = \sum_M \frac{1}{M!} \left( \sum_k e^{-\beta\varepsilon_k} \right)^M e^{M\beta\mu} \\ &= \sum_M \frac{1}{M!} \left( \sum_k e^{-\beta(\varepsilon_k - \mu)} \right)^M = \exp \left( \sum_k e^{-\beta(\varepsilon_k - \mu)} \right) \\ &= \prod_k \exp \left( e^{-\beta(\varepsilon_k - \mu)} \right). \end{aligned} \quad (7.56)$$

The grand free energy is

$$\Phi^{\text{NI,MB}} = -k_B T \log \Xi^{\text{NI,MB}} = \sum_k \Phi_k, \quad (7.57)$$

with the single-particle grand free energy

$$\Phi_k = -k_B T e^{-\beta(\varepsilon_k - \mu)}. \quad (7.58)$$

Finally, the expected<sup>27</sup> number of particles in a single-particle eigenstate with energy  $\varepsilon$  is

$$\langle n \rangle_{\text{MB}} = -\frac{\partial \Phi}{\partial \mu} = e^{-\beta(\varepsilon - \mu)}. \quad (7.60)$$

This is precisely the Boltzmann factor for filling the state that we expect for non-interacting distinguishable particles; the indistinguishability factor  $N!$  does not alter the filling of the non-interacting single-particle states.

## 7.6 Black-body radiation and Bose condensation

### 7.6.1 Free particles in a box

For this section and the next section on fermions, we shall simplify even further. We consider particles which are not only non-interacting and identical, but are also free. That is, they are subject to no external potential, apart from being confined in a box of volume  $L^3 = V$  with *periodic boundary conditions*.<sup>28</sup> The single-particle quantum eigenstates of such a system are products of sine and cosine waves along the three directions—for example, for any three non-negative integers  $n_i$ ,

$$\psi = \left( \frac{2}{L} \right)^{3/2} \cos \left( \frac{2\pi n_1}{L} x \right) \cos \left( \frac{2\pi n_2}{L} y \right) \cos \left( \frac{2\pi n_3}{L} z \right). \quad (7.61)$$

There are eight such states with the same energy, substituting sine for cosine in all possible combinations along the three directions. These are

more conveniently organized if we use the complex exponential instead of sine and cosine:

$$\psi_{\mathbf{k}} = (1/L)^{3/2} \exp(i\mathbf{k} \cdot \mathbf{r}), \quad (7.62)$$

with  $\mathbf{k} = (2\pi/L)(n_1, n_2, n_3)$  and the  $n_i$  can now be any integer.<sup>29</sup> The allowed single-particle eigenstates form a regular square grid in the space of wavevectors  $k$ , with an average density  $(L/2\pi)^3$  per unit volume of  $k$ -space:

$$\text{density of plane waves in } \mathbf{k}\text{-space} = V/8\pi^3. \quad (7.63)$$

For a large box volume  $V$ , the grid is extremely fine, and one can use a continuum approximation that the number of states falling into a  $\mathbf{k}$ -space region is given by its volume times the density (eqn 7.63).<sup>30</sup>

### 7.6.2 Black-body radiation

Our first application is to electromagnetic radiation. Electromagnetic radiation has plane-wave modes similar to eqn 7.62. Each plane wave travels at the speed of light  $c$ , so its frequency is  $\omega_k = c|\mathbf{k}|$ . There are two modes per wavevector  $\mathbf{k}$ , one for each polarization. When one quantizes the electromagnetic field, each mode becomes a quantum harmonic oscillator.

Before quantum mechanics, people could not understand the equilibration of electromagnetic radiation. The equipartition theorem predicted that if you could come to equilibrium, each mode would have  $k_B T$  of energy. Since there are immensely more wavevectors in the ultraviolet and X-ray ranges than in the infra-red and visible,<sup>31</sup> opening your oven door would theoretically give you a sun-tan or worse (the so-called *ultraviolet catastrophe*). Experiments saw a spectrum which looked compatible with this prediction for small frequencies, but was (fortunately) cut off at high frequencies.

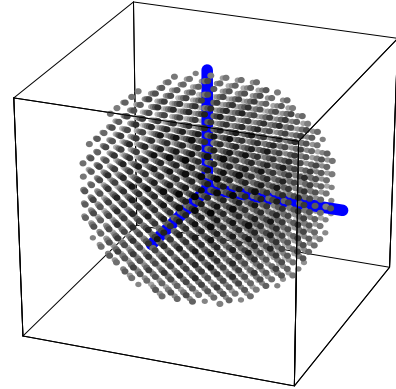
Let us calculate the equilibrium energy distribution inside our box at temperature  $T$ . The number of single-particle plane-wave eigenstates  $g(\omega) d\omega$  in a small range  $d\omega$  is<sup>32</sup>

$$g(\omega) d\omega = (4\pi k^2) \left( \frac{d|\mathbf{k}|}{d\omega} d\omega \right) \left( \frac{2V}{(2\pi)^3} \right), \quad (7.64)$$

where the first term is the surface area of the sphere of radius  $k$ , the second term is the thickness of the spherical shell for a small  $d\omega$ , and the last is the density of single-particle plane-wave eigenstate wavevectors times two (because there are two photon polarizations per wavevector). Knowing  $\mathbf{k}^2 = \omega^2/c^2$  and  $d|\mathbf{k}|/d\omega = 1/c$ , we find the density of plane-wave eigenstates per unit frequency:

$$g(\omega) = \frac{V\omega^2}{\pi^2 c^3}. \quad (7.65)$$

Now, the number of photons is not fixed; they can be created or destroyed, so their chemical potential  $\mu$  is zero.<sup>33</sup> Their energy  $\varepsilon_k = \hbar\omega_k$ . Finally, they are to an excellent approximation identical, non-interacting



**Fig. 7.7 k-sphere.** The allowed  $\mathbf{k}$ -space points for periodic boundary conditions form a regular grid. The points of equal energy lie on a sphere.

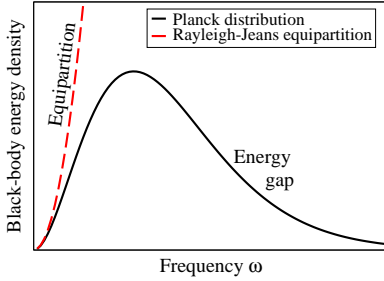
<sup>29</sup>The eight degenerate states are now given by the choices of sign for the three integers.

<sup>30</sup>Basically, the continuum limit works because the shape of the box (which affects the arrangements of the allowed  $\mathbf{k}$  vectors) is irrelevant to the physics so long as the box is large. For the same reason, the energy of the single-particle eigenstates is independent of direction; it will be proportional to  $|\mathbf{k}|$  for massless photons, and proportional to  $\mathbf{k}^2$  for massive bosons and electrons (Fig. 7.7). This makes the calculations in the following sections tractable.

<sup>31</sup>There are a thousand times more wavevectors with  $|k| < 10k_0$  than for  $|k| < k_0$ . The optical frequencies and wavevectors span roughly a factor of two (an octave for sound), so there are eight times as many optical modes as there are radio and infra-red modes.

<sup>32</sup>We are going to be sloppy and use  $g(\omega)$  as eigenstates per unit frequency for photons, and later we will use  $g(\varepsilon)$  as single-particle eigenstates per unit energy. Be warned:  $g_\omega(\omega) d\omega = g_\varepsilon(\hbar\omega) d\hbar\omega$ , so  $g_\omega = \hbar g_\varepsilon$ .

<sup>33</sup>See Exercise 7.2 to derive this from the quantum harmonic oscillator.



**Fig. 7.8 The Planck black-body radiation power spectrum**, with the Rayleigh–Jeans approximation, valid for low frequency  $\omega$ .

<sup>34</sup>Why is this called *black-body* radiation? A black surface absorbs all radiation at all frequencies. In equilibrium, the energy it absorbs at a given frequency must equal the energy it emits, otherwise it would push the system out of equilibrium. (This is called *detailed balance*, Section 8.2.) Hence, ignoring the small surface cooling due to radiation, a black body emits a thermal distribution of photons (see Exercise 7.7).

bosons, so the number of photons per eigenstate with frequency  $\omega$  is  $\langle n \rangle = 1/(e^{\hbar\omega/k_B T} - 1)$ . This gives us a number of photons:

$$(\# \text{ of photons}) \, d\omega = \frac{g(\omega)}{e^{\hbar\omega/k_B T} - 1} \, d\omega \tag{7.66}$$

and an electromagnetic (photon) energy per unit volume  $u(\omega)$  given by

$$\begin{aligned} V u(\omega) \, d\omega &= \frac{\hbar\omega g(\omega)}{e^{\hbar\omega/k_B T} - 1} \, d\omega \\ &= \frac{V\hbar}{\pi^2 c^3} \frac{\omega^3 \, d\omega}{e^{\hbar\omega/k_B T} - 1} \end{aligned} \tag{7.67}$$

(Fig. 7.8). This is Planck’s famous formula for black-body radiation.<sup>34</sup> At low frequencies, we can approximate  $e^{\hbar\omega/k_B T} - 1 \approx \hbar\omega/k_B T$ , yielding the Rayleigh–Jeans formula

$$\begin{aligned} V u_{\text{RJ}}(\omega) \, d\omega &= V \left( \frac{k_B T}{\pi^2 c^3} \right) \omega^2 \, d\omega \\ &= k_B T g(\omega), \end{aligned} \tag{7.68}$$

just as one would expect from equipartition:  $k_B T$  per classical harmonic oscillator.

For modes with frequencies high compared to  $k_B T/\hbar$ , equipartition no longer holds. The energy gap  $\hbar\omega$ , just as for the low-temperature specific heat from Section 7.2, leads to an excitation probability that is suppressed by the exponential Boltzmann factor  $e^{-\hbar\omega/k_B T}$  (eqn 7.67, approximating  $1/(e^{\hbar\omega/k_B T} - 1) \approx e^{-\hbar\omega/k_B T}$ ). Planck’s discovery that quantizing the energy averted the ultraviolet catastrophe was the origin of quantum mechanics, and led to his name being given to  $\hbar$ .

### 7.6.3 Bose condensation

How does our calculation change when the non-interacting free bosons cannot be created and destroyed? Let us assume that our bosons are spinless, have mass  $m$ , and are non-relativistic, so their energy is  $\varepsilon = p^2/2m = -\hbar^2 \nabla^2/2m$ . If we put them in our box with periodic boundary conditions, we can make the same continuum approximation to the density of states as we did in the case of black-body radiation. In eqn 7.63, the number of plane-wave eigenstates per unit volume in  $\mathbf{k}$ -space is  $V/8\pi^3$ , so the density in momentum space  $\mathbf{p} = \hbar\mathbf{k}$  is  $V/(2\pi\hbar)^3$ . For our massive particles  $d\varepsilon/d|\mathbf{p}| = |\mathbf{p}|/m = \sqrt{2\varepsilon/m}$ , so the number of plane-wave eigenstates in a small range of energy  $d\varepsilon$  is

$$\begin{aligned} g(\varepsilon) \, d\varepsilon &= (4\pi p^2) \left( \frac{d|\mathbf{p}|}{d\varepsilon} \, d\varepsilon \right) \left( \frac{V}{(2\pi\hbar)^3} \right) \\ &= (4\pi(2m\varepsilon)) \left( \sqrt{\frac{m}{2\varepsilon}} \, d\varepsilon \right) \left( \frac{V}{(2\pi\hbar)^3} \right) \\ &= \frac{V m^{3/2}}{\sqrt{2}\pi^2 \hbar^3} \sqrt{\varepsilon} \, d\varepsilon, \end{aligned} \tag{7.69}$$



where the first term is the surface area of the sphere in  $\mathbf{p}$ -space, the second is the thickness of the spherical shell, and the third is the density of plane-wave eigenstates per unit volume in  $\mathbf{p}$ -space.

Now we fill each of these single-particle plane-wave eigenstates with an expected number given by the Bose–Einstein distribution at chemical potential  $\mu$ ,  $1/(e^{(\varepsilon-\mu)/k_B T} - 1)$ . The total number of particles  $N$  is then given by

$$N(\mu) = \int_0^\infty \frac{g(\varepsilon)}{e^{(\varepsilon-\mu)/k_B T} - 1} d\varepsilon. \tag{7.70}$$

We must vary  $\mu$  in this equation to give us the correct number of particles  $N$ . For bosons, as noted in Section 7.4,  $\mu$  cannot be larger than the lowest single-particle eigenenergy (here  $\varepsilon_0 = 0$ ), so  $\mu$  will always be negative. For larger numbers of particles we raise  $\mu$  up from below, forcing more particles into each of the single-particle states. There is a limit, however, to how hard we can push; when  $\mu = 0$  the ground state gets a diverging number of particles.

For free bosons in three dimensions, the integral for  $N(\mu = 0)$  converges to a finite value.<sup>35</sup> Thus the largest number of particles  $N_{\max}^{\text{cont}}$  we can fit into our box within our continuum approximation for the density of states is the value of eqn 7.70 at  $\mu = 0$ :

$$\begin{aligned} N_{\max}^{\text{cont}} &= \int \frac{g(\varepsilon)}{e^{\varepsilon/k_B T} - 1} d\varepsilon \\ &= \frac{Vm^{3/2}}{\sqrt{2\pi^2\hbar^3}} \int_0^\infty d\varepsilon \frac{\sqrt{\varepsilon}}{e^{\varepsilon/k_B T} - 1} \\ &= V \left( \frac{\sqrt{2\pi mk_B T}}{h} \right)^3 \frac{2}{\sqrt{\pi}} \int_0^\infty \frac{\sqrt{z}}{e^z - 1} dz \\ &= \left( \frac{V}{\lambda^3} \right) \zeta(3/2). \end{aligned} \tag{7.71}$$

Here  $\zeta$  is the Riemann zeta function,<sup>36</sup> with  $\zeta(3/2) \approx 2.612$  and  $\lambda = h/\sqrt{2\pi mk_B T}$  is again the thermal de Broglie wavelength (eqn 3.59). Something new has to happen at a critical density:

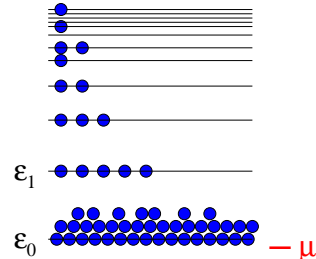
$$\frac{N_{\max}^{\text{cont}}}{V} = \frac{\zeta(3/2)}{\lambda^3} = \frac{2.612 \text{ particles}}{\text{deBroglie volume}}. \tag{7.72}$$

This has an elegant interpretation: the quantum statistics of the particles begin to dominate the behavior when they are within around a thermal de Broglie wavelength of one another.

What happens when we try to cram more particles in? Our approximation of the distribution of eigenstates as a continuum breaks down. Figure 7.9 shows a schematic illustration of the first few single-particle eigenvalues. When the distance between  $\mu$  and the bottom level  $\varepsilon_0$  becomes significantly smaller than the distance between the bottom and the next level  $\varepsilon_1$ , the continuum approximation (which approximates the filling of  $\varepsilon_0$  using an integral half-way to  $\varepsilon_1$ ) becomes qualitatively wrong. The low-energy states, viewed as a continuum, cannot accommodate the extra bosons. Instead, the lowest state absorbs all the extra particles

<sup>35</sup>At  $\mu = 0$ , the denominator of the integrand in eqn 7.70 is approximately  $\varepsilon/k_B T$  for small  $\varepsilon$ , but the numerator goes as  $\sqrt{\varepsilon}$ , so the integral converges at the lower end:  $\int_0^X \varepsilon^{-1/2} \sim (\frac{1}{2}\varepsilon^{1/2})|_0^X = \sqrt{X}/2$ .

<sup>36</sup>The Riemann  $\zeta$  function  $\zeta(s) = [1/(s-1)!] \int_0^\infty z^{s-1}/(e^z - 1) dz$  is famous for many reasons. It is related to the distribution of prime numbers. It is the subject of the famous unproven *Riemann hypothesis*, that its zeros in the complex plane, apart from those at the negative even integers, all have real part equal to  $1/2$ .



**Fig. 7.9 Bose condensation.** The chemical potential  $\mu$  is here so close to the ground state energy  $\varepsilon_0$  that the continuum approximation to the density of states breaks down. The ground state is macroscopically occupied (that is, filled by a non-zero fraction of the total number of particles  $N$ ).

<sup>37</sup>The next few states have quantitative corrections, but the continuum approximation is only off by small factors.

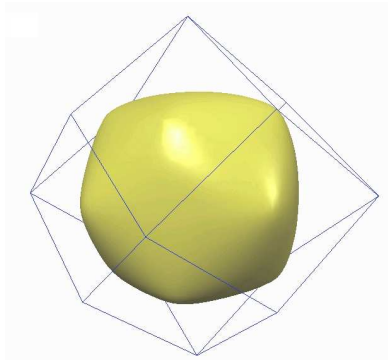
added to the system beyond  $N_{\max}^{\text{cont}}$ .<sup>37</sup> This is called *Bose–Einstein condensation*.

Usually we do not add particles at fixed temperature, instead we lower the temperature at fixed density  $N/V$ . Bose condensation then occurs at temperature

$$k_B T_c^{\text{BEC}} = \frac{h^2}{2\pi m} \left( \frac{N}{V\zeta(3/2)} \right)^{2/3}. \tag{7.73}$$

Bose condensation was first accomplished experimentally in 1995 (see Exercise 7.14).

Bose condensation has also long been considered the underlying principle behind superfluidity. Liquid He<sup>4</sup> undergoes an unusual transition at about 2.176 K to a state without viscosity; it will swirl round a circular tube for as long as your refrigeration lasts. The quantitative study of the superfluid transition involves the interactions between the helium atoms, and uses the scaling methods that we will introduce in Chapter 12. But it is interesting to note that the Bose condensation temperature for liquid He<sup>4</sup> (with  $m = 6.65 \times 10^{-24}$  g and volume per particle  $V/N = 27.6 \text{ cm}^3/\text{mole}$ ) is 3.13 K—quite close to the superfluid transition temperature.



**Fig. 7.10 The Fermi surface for lithium**, from [29]. The Fermi energy for lithium is 4.74 eV, with one conduction electron outside a helium closed shell. As for most metals, the Fermi energy in lithium is much larger than  $k_B$  times its melting point (4.74 eV = 55 000 K, melting point 453 K). Hence it is well described by this  $T = 0$  Fermi surface, slightly smeared by the Fermi function (Fig. 7.5).

<sup>38</sup>Equation 7.77 has an illuminating derivation in  $\mathbf{k}$ -space, where we fill all states with  $|\mathbf{k}| < k_F$ . Here the Fermi wavevector  $k_F$  has energy equal to the Fermi energy,  $\hbar k_F^2/2m = p_F^2/2m = \varepsilon_F$ , and hence  $k_F = \sqrt{2\varepsilon_F m}/\hbar$ . The resulting sphere of occupied states at  $T = 0$  is called the *Fermi sphere*. The number of fermions inside the Fermi sphere is thus the  $\mathbf{k}$ -space volume of the Fermi sphere times the  $\mathbf{k}$ -space density of states,

$$N = ((4/3)\pi k_F^3) \left( \frac{2V}{(2\pi)^3} \right) = \frac{k_F^3}{3\pi^2} V, \tag{7.76}$$

equivalent to eqn 7.77.

## 7.7 Metals and the Fermi gas

We claimed in Section 7.4 that many systems of strongly-interacting fermions (metals, neutron stars, nuclei) are surprisingly well described by a model of non-interacting fermions. Let us solve for the properties of  $N$  free non-interacting fermions in a box.

Let our particles be non-relativistic and have spin 1/2. The single-particle eigenstates are the same as those for bosons except that there are two states (spin up, spin down) per plane wave. Hence the density of states is given by twice that of eqn 7.69:

$$g(\varepsilon) = \frac{\sqrt{2}Vm^{3/2}}{\pi^2\hbar^3} \sqrt{\varepsilon}. \tag{7.74}$$

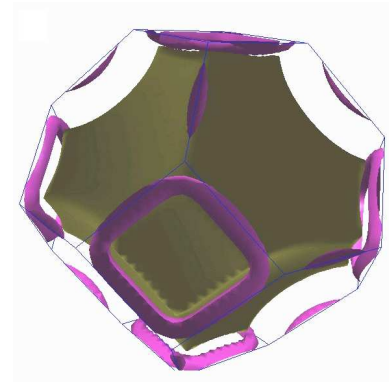
The number of fermions at chemical potential  $\mu$  is given by integrating  $g(\varepsilon)$  times the expected number of fermions in a state of energy  $\varepsilon$ , given by the Fermi function  $f(\varepsilon)$  of eqn 7.48:

$$N(\mu) = \int_0^\infty g(\varepsilon)f(\varepsilon) d\varepsilon = \int_0^\infty \frac{g(\varepsilon)}{e^{(\varepsilon-\mu)/k_B T} + 1} d\varepsilon. \tag{7.75}$$

What chemical potential will give us  $N$  fermions? At non-zero temperature, one must do a self-consistent calculation, but at  $T = 0$  one can find  $N$  by counting the number of states below  $\mu$ . In the zero-temperature limit (Fig. 7.5) the Fermi function is a step function  $f(\varepsilon) = \Theta(\mu - \varepsilon)$ ; all states below  $\mu$  are filled, and all states above  $\mu$  are empty. The zero-temperature value of the chemical potential is called the *Fermi energy*  $\varepsilon_F$ . We can find the number of fermions by integrating up to  $\mu = \varepsilon_F$ .<sup>38</sup>

$$N = \int_0^{\epsilon_F} g(\epsilon) d\epsilon = \frac{\sqrt{2}m^{3/2}}{\pi^2\hbar^3} V \int_0^{\epsilon_F} \sqrt{\epsilon} d\epsilon = \frac{(2\epsilon_F m)^{3/2}}{3\pi^2\hbar^3} V. \quad (7.77)$$

We mentioned earlier that the independent fermion approximation was startlingly useful even though the interactions are not small. Ignoring the Coulomb repulsion between electrons in a metal, or the strong interaction between neutrons in a neutron star, gives an excellent description of their actual behavior. However, our calculation above also assumed that the electrons are free particles, experiencing no external potential. This approximation is not particularly accurate in general; the interactions with the atomic nuclei are important, and is primarily what makes one material different from another. In particular, the atoms in a crystal will form a periodic potential for the electrons.<sup>39</sup> One can show that the single-particle eigenstates in a periodic potential are periodic functions times  $\exp(i\mathbf{k}\cdot\mathbf{r})$ , with exactly the same wavevectors  $\mathbf{k}$  as in the free fermion case. The filling of the Fermi surface in  $\mathbf{k}$ -space is changed only insofar as the energies of these single-particle states are no longer isotropic. Some metals (particularly the alkali metals, like lithium in Fig. 7.10) have roughly spherical Fermi surfaces; many (see Fig. 7.11 for aluminum) are quite intricate, with several pieces to them [9, chapters 9–11].



**Fig. 7.11 The Fermi surface for aluminum**, also from [29]. Aluminum has a Fermi energy of 11.7eV, with three conduction electrons outside a Ne closed shell.

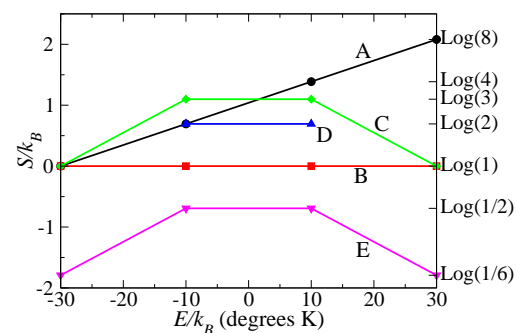
<sup>39</sup>Rather than using the Coulomb potential for the nucleus, a better approximation is given by incorporating the effects of the *inner shell* electrons into the periodic potential, and filling the Fermi sea with the remaining *conduction* electrons.

## Exercises

We start with two exercises on the different types of identical particle statistics: *Ensembles and quantum statistics* and *Phonons and photons are bosons*. We then use quantum mechanics to set the scale of classical statistical mechanics in *Phase-space units and the zero of entropy*, and ask again *Does entropy increase in quantum systems?* In *Photon density matrices* and *Spin density matrix* we give elementary examples of this advanced topic.

Quantum statistical mechanics is the foundation of many fields. We start with three examples from optics: *Light emission and absorption*, *Einstein’s A and B*, and *Bosons are gregarious: superfluids and lasers*. We provide three prototypical calculations in condensed-matter physics: *Crystal defects*, *Phonons on a string*, and *Fermions in semiconductors*. We provide two exercises on Bose condensation: *Bose condensation in a band* and *Bose condensation: the experiment*. Finally, we introduce two primary applications to astrophysics: *The photon-dominated Universe* and *White dwarfs, neutron stars, and black holes*.

### (7.1) Ensembles and quantum statistics. (Quantum) ③



**Fig. 7.12 Microcanonical three particles.**

A system has two single-particle eigenfunctions, with energies (measured in degrees Kelvin)  $E_0/k_B = -10$  and  $E_2/k_B = 10$ . Experiments are performed by adding three non-interacting particles to these two states, ei-

ther identical spin-1/2 fermions, identical spinless bosons, distinguishable particles, or spinless identical particles obeying Maxwell–Boltzmann statistics. Please make a table for this exercise, giving your answers for the four cases (Fermi, Bose, Distinguishable, and Maxwell–Boltzmann) for each of the three parts. Substantive calculations may be needed.

(a) *The system is first held at constant energy. In Fig. 7.12 which curve represents the entropy of the fermions as a function of the energy? Bosons? Distinguishable particles? Maxwell–Boltzmann particles?*

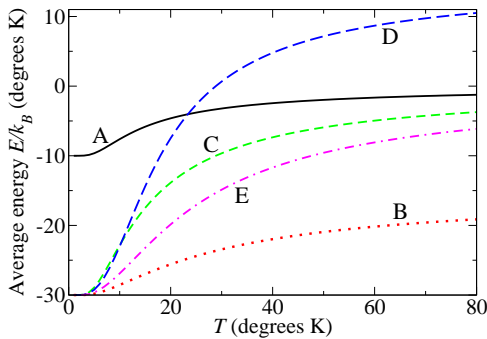


Fig. 7.13 Canonical three particles.

(b) *The system is now held at constant temperature. In Fig. 7.13 which curve represents the mean energy of the fermions as a function of the temperature? Bosons? Distinguishable particles? Maxwell–Boltzmann particles?*

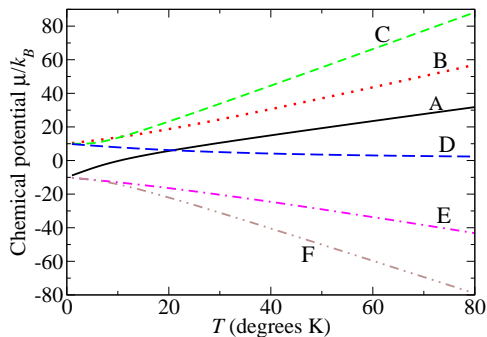


Fig. 7.14 Grand canonical three particles.

(c) *The system is now held at constant temperature, with chemical potential set to hold the average number of particles equal to three. In Fig. 7.14, which curve represents the chemical potential of the fermions as a function of temperature? Bosons? Distinguishable? Maxwell–Boltzmann?*

(7.2) **Phonons and photons are bosons.** (Quantum) ③

Phonons and photons are the elementary, harmonic excitations of the elastic and electromagnetic fields. We have seen in Exercise 7.11 that phonons are decoupled harmonic oscillators, with a distribution of frequencies  $\omega$ . A similar analysis shows that the Hamiltonian of the electromagnetic field can be decomposed into harmonic normal modes called photons.

This exercise will explain why we think of phonons and photons as particles, instead of excitations of harmonic modes.

(a) *Show that the canonical partition function for a quantum harmonic oscillator of frequency  $\omega$  is the same as the grand canonical partition function for bosons multiply filling a single state with energy  $\hbar\omega$ , with  $\mu = 0$  (apart from a shift in the arbitrary zero of the total energy of the system).*

The Boltzmann filling of a harmonic oscillator is therefore the same as the Bose–Einstein filling of bosons into a single quantum state, except for an extra shift in the energy of  $\hbar\omega/2$ . This extra shift is called the *zero-point energy*. The excitations within the harmonic oscillator are thus often considered as particles with Bose statistics: the  $n$ th excitation is  $n$  bosons occupying the oscillator’s quantum state.

This particle analogy becomes even more compelling for systems like phonons and photons where there are many harmonic oscillator states labeled by a wavevector  $k$  (see Exercise 7.11). Real, massive Bose particles like  $\text{He}^4$  in free space have single-particle quantum eigenstates with a dispersion relation<sup>40</sup>  $\varepsilon_k = \hbar^2 k^2 / 2m$ . Phonons and photons have one harmonic oscillator for every  $k$ , with an excitation energy  $\varepsilon_k = \hbar\omega_k$ . If we treat them, as in part (a), as bosons filling these as single-particle states we find that they are completely analogous to ordinary massive particles. (Photons even have the dispersion relation of a massless boson. If we

<sup>40</sup>The *dispersion relation* is the relationship between energy and wavevector, here  $\varepsilon_k$ .

take the mass to zero of a relativistic particle,  $\varepsilon = \sqrt{m^2 c^4 - \mathbf{p}^2 c^2} \rightarrow |\mathbf{p}|c = \hbar c |\mathbf{k}|$ .

(b) Do phonons or photons Bose condense at low temperatures? Can you see why not? Can you think of a non-equilibrium Bose condensation of photons, where a macroscopic occupation of a single frequency and momentum state occurs?

(7.3) **Phase-space units and the zero of entropy.** (Quantum) ③

In classical mechanics, the entropy  $S = k_B \log \Omega$  goes to minus infinity as the temperature is lowered to zero. In quantum mechanics the entropy per particle goes to zero,<sup>41</sup> because states are quantized and the ground state is the only one populated. This is Nernst's theorem, the third law of thermodynamics.

The classical phase-space shell volume  $\Omega(E) \delta E$  (eqn 3.5) has units of ((momentum) × (distance))<sup>3N</sup>. It is a little perverse to take the logarithm of a quantity with units. The natural candidate with these dimensions is Planck's constant  $h^{3N}$ ; if we measure phase-space volume in units of  $h$  per dimension,  $\Omega(E) \delta E$  will be dimensionless. Of course, the correct dimension could be a constant times  $h$ , like  $\hbar$ ...

(a) Arbitrary zero of the classical entropy. Show that the width of the energy shell  $\delta E$  in the definition of  $\Omega(E)$  does not change the microcanonical entropy per particle  $S/N = k_B \log(\Omega(E))/N$  in a large system. Show that the choice of units in phase space does change the classical entropy per particle.

We want to choose the units of classical phase-space volume so that the entropy agrees with the quantum entropy at high temperatures. How many quantum eigenstates per unit volume of classical phase space should we expect at high energies? We will fix these units by matching the quantum result to the classical one for a particular system, and then check it using a second system. Let us start with a free particle.

(b) Phase-space density of states for a particle in a one-dimensional box. Show, or note, that the quantum momentum-space density of states for a free quantum particle in a one-dimensional box of length  $L$  with periodic boundary conditions is

$L/h$ . Draw a picture of the classical phase space of this box ( $p, x$ ), and draw a rectangle of length  $L$  for each quantum eigenstate. Is the phase-space area per eigenstate equal to  $h$ , as we assumed in Section 3.5?

This works also for  $N$  particles in a three-dimensional box.

(c) Phase-space density of states for  $N$  particles in a box. Show that the density of states for  $N$  free particles in a cubical box of volume  $V$  with periodic boundary conditions is  $V^N/h^{3N}$ , and hence that the phase-space volume per state is  $h^{3N}$ .

Let us see if this choice of units<sup>42</sup> also works for the harmonic oscillator.

(d) Phase-space density of states for a harmonic oscillator. Consider a harmonic oscillator with Hamiltonian  $\mathcal{H} = p^2/2m + \frac{1}{2}m\omega^2 q^2$ . Draw a picture of the energy surface with energy  $E$ , and find the volume (area) of phase space enclosed. (Hint: The area of an ellipse is  $\pi r_1 r_2$  where  $r_1$  and  $r_2$  are the largest and smallest radii, corresponding to the major and minor axes.) What is the volume per energy state, the volume between  $E_n$  and  $E_{n+1}$ , for the eigenenergies  $E_n = (n + \frac{1}{2})\hbar\omega$ ?

(7.4) **Does entropy increase in quantum systems?** (Mathematics, Quantum) ③

We saw in Exercise 5.7 that in classical Hamiltonian systems the non-equilibrium entropy  $S_{\text{nonequil}} = -k_B \int \rho \log \rho$  is constant in a classical mechanical Hamiltonian system. Here you will show that in the microscopic evolution of an isolated quantum system, the entropy is also time independent, even for general, time-dependent density matrices  $\rho(t)$ .

Using the evolution law (eqn 7.19)  $\partial\rho/\partial t = [\mathcal{H}, \rho]/(i\hbar)$ , prove that  $S = \text{Tr}(\rho \log \rho)$  is time independent, where  $\rho$  is any density matrix. (Hint: Go to an orthonormal basis  $\psi_i$  which diagonalizes  $\rho$ . Show that  $\psi_i(t)$  is also orthonormal, and take the trace in that basis. Use the cyclic invariance of the trace.)

<sup>41</sup>If the ground state is degenerate, the entropy does not go to zero, but it typically stays finite as the number of particles  $N$  gets big, so for large  $N$  the entropy per particle goes to zero.

<sup>42</sup>You show here that ideal gases should calculate entropy using phase-space units with  $h = 1$ . To argue this directly for interacting systems usually involves semiclassical quantization [70, chapter 48, p. 170] or path integrals [39]. But it must be true. We could imagine measuring the entropy difference between the interacting system and an ideal gas, by slowly and reversibly turning off the interactions between the particles, measuring the entropy flow into or out of the system. Thus, setting the zero of entropy for the ideal gas sets it for all systems.

(7.5) **Photon density matrices.** (Quantum) ③  
 Write the density matrix for a vertically polarized photon  $|V\rangle$  in the basis where  $|V\rangle = \begin{pmatrix} 1 \\ 0 \end{pmatrix}$  and a horizontal photon  $|H\rangle = \begin{pmatrix} 0 \\ 1 \end{pmatrix}$ . Write the density matrix for a diagonally polarized photon,  $(1/\sqrt{2}, 1/\sqrt{2})$ , and the density matrix for unpolarized light (note 2 on p. 136). Calculate  $\text{Tr}(\rho)$ ,  $\text{Tr}(\rho^2)$ , and  $S = -k_B \text{Tr}(\rho \log \rho)$ . Interpret the values of the three traces physically. (Hint: One is a check for pure states, one is a measure of information, and one is a normalization.)

(7.6) **Spin density matrix.**<sup>43</sup> (Quantum) ③  
 Let the Hamiltonian for a spin be

$$\mathcal{H} = -\frac{\hbar}{2} \mathbf{B} \cdot \vec{\sigma}, \tag{7.78}$$

where  $\vec{\sigma} = (\sigma_x, \sigma_y, \sigma_z)$  are the three Pauli spin matrices, and  $\mathbf{B}$  may be interpreted as a magnetic field, in units where the gyromagnetic ratio is unity. Remember that  $\sigma_i \sigma_j - \sigma_j \sigma_i = 2i \epsilon_{ijk} \sigma_k$ . Show that any  $2 \times 2$  density matrix may be written in the form

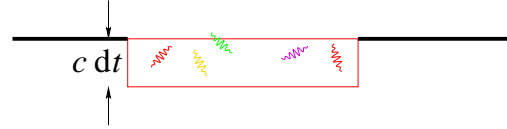
$$\rho = \frac{1}{2} (\mathbf{1} + \mathbf{p} \cdot \vec{\sigma}). \tag{7.79}$$

Show that the equations of motion for the density matrix  $i\hbar \partial \rho / \partial t = [\mathcal{H}, \rho]$  can be written as  $d\mathbf{p}/dt = -\mathbf{B} \times \mathbf{p}$ .

(7.7) **Light emission and absorption.** (Quantum) ②

The experiment that Planck was studying did not directly measure the energy density per unit frequency (eqn 7.67) inside a box. It measured the energy radiating out of a small hole, of area  $A$ . Let us assume the hole is on the upper face of the cavity, perpendicular to the  $z$  axis.

What is the photon distribution just inside the boundary of the hole? Few photons come into the hole from the outside, so the distribution is depleted for those photons with  $v_z < 0$ . However, the photons with  $v_z > 0$  to an excellent approximation should be unaffected by the hole—since they were emitted from far distant walls of the cavity, where the existence of the hole is a negligible perturbation. So, presuming the relevant photons just inside the hole are distributed in the same way as in the box as a whole (eqn 7.67), how many leave in a time  $dt$ ?



**Fig. 7.15 Photon emission from a hole.** The photons leaving a cavity in a time  $dt$  are those within  $v_z dt$  of the hole.

As one can see geometrically (Fig. 7.15), those photons within  $v_z dt$  of the boundary will escape in time  $dt$ . The vertical velocity  $v_z = c \cos(\theta)$ , where  $\theta$  is the photon velocity angle with respect to the vertical. The Planck distribution is isotropic, so the probability that a photon will be moving at an angle  $\theta$  is the perimeter of the  $\theta$  circle on the sphere divided by the area of the sphere,  $2\pi \sin(\theta) d\theta / (4\pi) = \frac{1}{2} \sin(\theta) d\theta$ .

(a) Show that the probability density<sup>44</sup>  $\rho(v_z)$  for a particular photon to have velocity  $v_z$  is independent of  $v_z$  in the range  $(-c, c)$ , and thus is  $1/2c$ . (Hint:  $\rho(v_z) \Delta v_z = \rho(\theta) \Delta \theta$ .)

An upper bound on the energy emitted from a hole of area  $A$  is given by the energy in the box as a whole (eq. 7.67) times the fraction  $Ac dt/V$  of the volume within  $c dt$  of the hole.

(b) Show that the actual energy emitted is  $1/4$  of this upper bound. (Hint: You will need to integrate  $\int_0^c \rho(v_z) v_z dv_z$ .)

Hence the power per unit area emitted from the small hole in equilibrium is

$$P_{\text{black}}(\omega, T) = \left(\frac{c}{4}\right) \frac{\hbar}{\pi^2 c^3} \frac{\omega^3 d\omega}{e^{\hbar\omega/k_B T} - 1}. \tag{7.80}$$

Why is this called black-body radiation? Certainly a small hole in a large (cold) cavity looks black—any light entering the hole bounces around inside until it is absorbed by the walls. Suppose we placed a black object—a material that absorbed radiation at all frequencies and angles—capping the hole. This object would absorb radiation from the cavity, rising in temperature until it came to equilibrium with the cavity—emitting just as much radiation as it absorbs. Thus the overall power per unit area emitted by our black object in equilibrium at a given temperature must equal that of the hole. This must also be true if we place a selective filter between the hole and our black body, passing

<sup>43</sup>Adapted from exam question by Bert Halperin, Harvard University, 1976.

<sup>44</sup>We are being sloppy again, using the same name  $\rho$  for the probability densities per unit velocity and per unit angle.

through only particular types of photons. Thus the emission and absorption of our black body must agree with the hole for every photon mode individually, an example of the *principle of detailed balance* we will discuss in more detail in Section 8.2.

How much power per unit area  $P_{\text{colored}}(\omega, T)$  is emitted in equilibrium at temperature  $T$  by a red or maroon body? A white body? A mirror? These objects are different in the fraction of incident light they absorb at different frequencies and angles  $a(\omega, \theta)$ . We can again use the principle of detailed balance, by placing our colored object next to a black body and matching the power emitted and absorbed for each angle and frequency:

$$P_{\text{colored}}(\omega, T, \theta) = P_{\text{black}}(\omega, T)a(\omega, \theta). \quad (7.81)$$

Finally, we should calculate  $Q_{\text{tot}}(T)$ , the total power per unit area emitted from a black body at temperature  $T$ , by integrating eqn 7.80 over frequency.

(c) Using the fact that  $\int_0^\infty x^3/(e^x - 1) dx = \pi^4/15$ , show that

$$Q_{\text{tot}}(T) = \int_0^\infty P_{\text{black}}(\omega, T) d\omega = \sigma T^4 \quad (7.82)$$

and give a formula for the Stefan–Boltzmann constant  $\sigma$ . ( $\sigma = 5.67 \times 10^{-5} \text{ erg cm}^{-2} \text{ K}^{-4} \text{ s}^{-1}$ ; use this to check your answer.)

(7.8) **Einstein's A and B.** (Quantum, Optics, Mathematics) ③

Einstein used statistical mechanics to deduce basic truths about the interaction of light with matter very early in the development of quantum mechanics. In particular, he established that *stimulated emission* was demanded for statistical mechanical consistency, and found formulæ determining the relative rates of absorption, spontaneous emission, and stimulated emission. (See Feynman [41, I.42–5].)

Consider a system consisting of non-interacting atoms weakly coupled to photons (electromagnetic radiation), in equilibrium at temperature  $k_B T = 1/\beta$ . The atoms have two energy eigenstates  $E_1$  and  $E_2$  with average populations  $N_1$  and  $N_2$ ; the relative population is given as usual by the Boltzmann distribution

$$\left\langle \frac{N_2}{N_1} \right\rangle = e^{-\beta(E_2 - E_1)}. \quad (7.83)$$

The energy density in the electromagnetic field is given by the Planck distribution (eqn 7.67):

$$u(\omega) = \frac{\hbar}{\pi^2 c^3} \frac{\omega^3}{e^{\beta \hbar \omega} - 1}. \quad (7.84)$$

An atom in the ground state will absorb electromagnetic energy from the photons at a rate that is proportional to the energy density  $u(\omega)$  at the excitation energy  $\hbar\omega = E_2 - E_1$ . Let us define this absorption rate per atom to be  $2\pi B u(\omega)$ .<sup>45</sup> An atom in the excited state  $E_2$ , with no electromagnetic stimulation, will decay into the ground state with a rate  $A$ , emitting a photon. Einstein noted that neither  $A$  nor  $B$  should depend upon temperature.

Einstein argued that using just these two rates would lead to an inconsistency.

(a) Compute the long-time average ratio  $N_2/N_1$  assuming only absorption and spontaneous emission. Even in the limit of weak coupling (small  $A$  and  $B$ ), show that this equation is incompatible with the statistical distributions 7.83 and 7.84. (Hint: Write a formula for  $dN_1/dt$ , and set it equal to zero. Is the resulting  $B/A$  temperature independent?)

Einstein fixed this by introducing stimulated emission. Roughly speaking, an atom experiencing an oscillating electromagnetic field is more likely to emit photons into that mode. Einstein found that the stimulated emission rate had to be a constant  $2\pi B'$  times the energy density  $u(\omega)$ .

(b) Write the equation for  $dN_1/dt$ , including absorption (a negative term) and spontaneous and stimulated emission from the population  $N_2$ . Assuming equilibrium, use this equation and eqns 7.83 and 7.84 to solve for  $B$ , and  $B'$  in terms of  $A$ . These are generally termed the Einstein  $A$  and  $B$  coefficients.

Let us express the stimulated emission rate in terms of the number of excited photons per mode (see Exercise 7.9(a) for an alternative derivation).

(c) Show that the rate of decay of excited atoms  $A + 2\pi B' u(\omega)$  is enhanced by a factor of  $\langle n \rangle + 1$  over the zero temperature rate, where  $\langle n \rangle$  is the expected number of photons in a mode at frequency  $\hbar\omega = E_2 - E_1$ .

<sup>45</sup>The literature uses  $u_{\text{cycles}}(f)$  where  $f = \omega/2\pi$  is in cycles per second, and has no factor of  $2\pi$ . Since  $u_{\text{cycles}}(f) df = u(\omega) d\omega$ , the absorption rate  $B u_{\text{cycles}}(f) = B u(\omega) d\omega/df = 2\pi B u(\omega)$ .

- (7.9) **Bosons are gregarious: superfluids and lasers.** (Quantum, Optics, Atomic physics) ③ *Adding a particle to a Bose condensate.* Suppose we have a non-interacting system of bosonic atoms in a box with single-particle eigenstates  $\psi_n$ . Suppose the system begins in a Bose-condensed state with all  $N$  bosons in a state  $\psi_0$ , so

$$\Psi_N^{[0]}(\mathbf{r}_1, \dots, \mathbf{r}_N) = \psi_0(\mathbf{r}_1) \cdots \psi_0(\mathbf{r}_N). \quad (7.85)$$

Suppose a new particle is gently injected into the system, into an equal superposition of the  $M$  lowest single-particle states.<sup>46</sup> That is, if it were injected into an empty box, it would start in state

$$\phi(\mathbf{r}_{N+1}) = \frac{1}{\sqrt{M}}(\psi_0(\mathbf{r}_{N+1}) + \psi_1(\mathbf{r}_{N+1}) + \dots + \psi_{M-1}(\mathbf{r}_{N+1})). \quad (7.86)$$

The state  $\Phi(\mathbf{r}_1, \dots, \mathbf{r}_{N+1})$  after the particle is inserted into the non-interacting Bose condensate is given by symmetrizing the product function  $\Psi_N^{[0]}(\mathbf{r}_1, \dots, \mathbf{r}_N)\phi(\mathbf{r}_{N+1})$  (eqn 7.30).

(a) Calculate the symmetrized initial state of the system with the injected particle. Show that the ratio of the probability that the new boson enters the ground state ( $\psi_0$ ) is enhanced over that of its entering an empty state ( $\psi_m$  for  $0 < m < M$ ) by a factor  $N + 1$ . (Hint: First do it for  $N = 1$ .)

So, if a macroscopic number of bosons are in one single-particle eigenstate, a new particle will be much more likely to add itself to this state than to any of the microscopically populated states. Notice that nothing in your analysis depended on  $\psi_0$  being the lowest energy state. If we started with a macroscopic number of particles in a single-particle state with wavevector  $\mathbf{k}$  (that is, a superfluid with a supercurrent in direction  $\mathbf{k}$ ), new added particles, or particles scattered by inhomogeneities, will preferentially enter into that state. This is an alternative approach to understanding the persistence of supercurrents, complementary to the topological approach (Exercise 9.7).

*Adding a photon to a laser beam.* This ‘chummy’ behavior between bosons is also the principle behind lasers.<sup>47</sup> A laser has  $N$  photons in a par-

ticular mode. An atom in an excited state emits a photon. The photon it emits will prefer to join the laser beam than to go off into one of its other available modes by a factor  $N + 1$ . Here the  $N$  represents *stimulated emission*, where the existing electromagnetic field pulls out the energy from the excited atom, and the  $+1$  represents *spontaneous emission* which occurs even in the absence of existing photons.

Imagine a single atom in a state with excitation energy  $E$  and decay rate  $\Gamma$ , in a cubical box of volume  $V$  with periodic boundary conditions for the photons. By the energy-time uncertainty principle,  $\langle \Delta E \Delta t \rangle \geq \hbar/2$ , the energy of the atom will be uncertain by an amount  $\Delta E \propto \hbar\Gamma$ . Assume for simplicity that, in a cubical box without pre-existing photons, the atom would decay at an equal rate into any mode in the range  $E - \hbar\Gamma/2 < \hbar\omega < E + \hbar\Gamma/2$ .

(b) Assuming a large box and a small decay rate  $\Gamma$ , find a formula for the number of modes  $M$  per unit volume  $V$  competing for the photon emitted from our atom. Evaluate your formula for a laser with wavelength  $\lambda = 619$  nm and the linewidth  $\Gamma = 10^4$  rad/s. (Hint: Use the density of states, eqn 7.65.)

Assume the laser is already in operation, so there are  $N$  photons in the volume  $V$  of the lasing material, all in one plane-wave state (a *single-mode* laser).

(c) Using your result from part (a), give a formula for the number of photons per unit volume  $N/V$  there must be in the lasing mode for the atom to have 50% likelihood of emitting into that mode.

The main task in setting up a laser is providing a population of excited atoms. Amplification can occur if there is a *population inversion*, where the number of excited atoms is larger than the number of atoms in the lower energy state (definitely a non-equilibrium condition). This is made possible by *pumping* atoms into the excited state by using one or two other single-particle eigenstates.

<sup>46</sup>For free particles in a cubical box of volume  $V$ , injecting a particle at the origin  $\phi(\mathbf{r}) = \delta(\mathbf{r})$  would be a superposition of all plane-wave states of equal weight,  $\delta(\mathbf{r}) = (1/V) \sum_{\mathbf{k}} e^{i\mathbf{k}\cdot\mathbf{r}}$ . (In second-quantized notation,  $a^\dagger(\mathbf{x} = 0) = (1/V) \sum_{\mathbf{k}} a_{\mathbf{k}}^\dagger$ .) We ‘gently’ add a particle at the origin by restricting this sum to low-energy states. This is how quantum tunneling into condensed states (say, in Josephson junctions or scanning tunneling microscopes) is usually modeled.

<sup>47</sup>Laser is an acronym for ‘light amplification by the stimulated emission of radiation’.



(7.10) **Crystal defects.** (Quantum, Condensed matter) ②

A defect in a crystal has one on-center configuration with energy zero, and  $M$  off-center configurations with energy  $\epsilon$ , with no significant quantum tunneling between the states. The Hamiltonian can be approximated by the  $(M + 1) \times (M + 1)$  matrix

$$\mathcal{H} = \begin{pmatrix} 0 & 0 & 0 & \cdots \\ 0 & \epsilon & 0 & \cdots \\ 0 & 0 & \epsilon & \cdots \end{pmatrix}. \quad (7.87)$$

There are  $N$  defects in the crystal, which can be assumed stuck in position (and hence distinguishable) and assumed not to interact with one another.

Write the canonical partition function  $Z(T)$ , the mean energy  $E(T)$ , the fluctuations in the energy, the entropy  $S(T)$ , and the specific heat  $C(T)$  as a function of temperature. Plot the specific heat per defect  $C(T)/N$  for  $M = 6$ ; set the unit of energy equal to  $\epsilon$  and  $k_B = 1$  for your plot. Derive a simple relation between  $M$  and the change in entropy between zero and infinite temperature. Check this relation using your formula for  $S(T)$ .

The bump in the specific heat for a two-state system is called a *Schottky anomaly*.

(7.11) **Phonons on a string.** (Quantum, Condensed matter) ③

A continuum string of length  $L$  with mass per unit length  $\mu$  under tension  $\tau$  has a vertical, transverse displacement  $u(x, t)$ . The kinetic energy density is  $(\mu/2)(\partial u/\partial t)^2$  and the potential energy density is  $(\tau/2)(\partial u/\partial x)^2$ . The string has fixed boundary conditions at  $x = 0$  and  $x = L$ .

Write the kinetic energy and the potential energy in new variables, changing from  $u(x, t)$  to normal modes  $q_k(t)$  with  $u(x, t) = \sum_n q_{k_n}(t) \sin(k_n x)$ ,  $k_n = n\pi/L$ . Show in these variables that the system is a sum of decoupled harmonic oscillators. Calculate the density of normal modes per unit frequency  $g(\omega)$  for a long string  $L$ . Calculate the specific heat of the string  $c(T)$  per unit length in the limit  $L \rightarrow \infty$ , treating the oscillators quantum mechanically. What is the specific heat of the classical string?

Almost the same calculation, in three dimensions, gives the low-temperature specific heat of crystals.

(7.12) **Semiconductors.** (Quantum, Condensed matter) ③

Let us consider a caricature model of a doped semiconductor [9, chapter 28]. Consider a crystal of phosphorous-doped silicon, with  $N - M$  atoms of silicon and  $M$  atoms of phosphorous. Each silicon atom contributes one electron to the system, and has two states at energies  $\pm\Delta/2$ , where  $\Delta = 1.16$  eV is the energy gap. Each phosphorous atom contributes *two* electrons and two states, one at  $-\Delta/2$  and the other at  $\Delta/2 - \epsilon$ , where  $\epsilon = 0.044$  eV is much smaller than the gap.<sup>48</sup> (Our model ignores the quantum mechanical hopping between atoms that broadens the levels at  $\pm\Delta/2$  into the conduction band and the valence band. It also ignores spin and chemistry; each silicon really contributes four electrons and four levels, and each phosphorous five electrons and four levels.) To summarize, our system has  $N + M$  spinless electrons (maximum of one electron per state),  $N$  valence band states at energy  $-\Delta/2$ ,  $M$  impurity band states at energy  $\Delta/2 - \epsilon$ , and  $N - M$  conduction band states at energy  $\Delta/2$ .

(a) Derive a formula for the number of electrons as a function of temperature  $T$  and chemical potential  $\mu$  for the energy levels of our system.

(b) What is the limiting occupation probability for the states as  $T \rightarrow \infty$ , where entropy is maximized and all states are equally likely? Using this, find a formula for  $\mu(T)$  valid at large  $T$ , not involving  $\Delta$  or  $\epsilon$ .

(c) Draw an energy level diagram showing the filled and empty states at  $T = 0$ . Find a formula for  $\mu(T)$  in the low-temperature limit  $T \rightarrow 0$ , not involving the variable  $T$ . (Hint: Balance the number of holes in the impurity band with the number of electrons in the conduction band. Why can you ignore the valence band?)

(d) In a one centimeter cubed sample, there are  $M = 10^{16}$  phosphorous atoms; silicon has about  $N = 5 \times 10^{22}$  atoms per cubic centimeter. Find  $\mu$  at room temperature (1/40 eV) from the formula you derived in part (a). (Probably trying various  $\mu$  is easiest; set up a program on your calculator or computer.) At this temperature, what fraction of the phosphorous atoms are ionized (have their upper energy state empty)? What is the density of holes (empty states at energy  $-\Delta/2$ )?

<sup>48</sup>The phosphorous atom is neutral when both of its states are filled; the upper state can be thought of as an electron bound to a phosphorous positive ion. The energy shift  $\epsilon$  represents the Coulomb attraction of the electron to the phosphorous ion; it is small because the dielectric constant is large semiconductor [9, chapter 28].

Phosphorous is an *electron donor*, and our sample is doped *n*-type, since the dominant carriers are electrons; *p*-type semiconductors are doped with holes.

(7.13) **Bose condensation in a band.** (Atomic physics, Quantum) ②

The density of single-particle eigenstates  $g(E)$  of a system of non-interacting bosons forms a band; the eigenenergies are confined to a range  $E_{\min} < E < E_{\max}$ , so  $g(E)$  is non-zero in this range and zero otherwise. The system is filled with a finite density of bosons. Which of the following is necessary for the system to undergo Bose condensation at low temperatures?

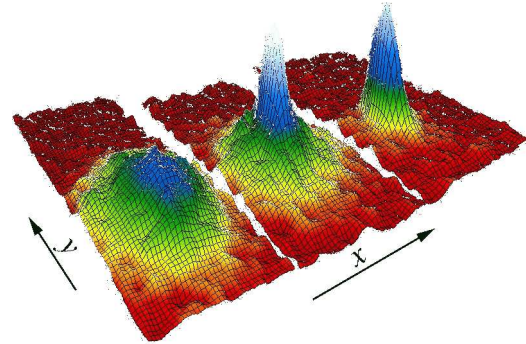
- (a)  $g(E)/(e^{\beta(E-E_{\min})}+1)$  is finite as  $E \rightarrow E_{\min}^-$ .
- (b)  $g(E)/(e^{\beta(E-E_{\min})} - 1)$  is finite as  $E \rightarrow E_{\min}^-$ .
- (c)  $E_{\min} \geq 0$ .
- (d)  $\int_{E_{\min}}^E g(E')/(E' - E_{\min})dE'$  is a convergent integral at the lower limit  $E_{\min}$ .
- (e) Bose condensation cannot occur in a system whose states are confined to an energy band.

(7.14) **Bose condensation: the experiment.** (Quantum, Atomic physics) ④

Anderson, Ensher, Matthews, Wieman and Cornell in 1995 were able to get a dilute gas of rubidium-87 atoms to Bose condense [4].

- (a) *Is rubidium-87 (37 protons and electrons, 50 neutrons) a boson or a fermion?*
- (b) *At their quoted maximum number density of  $2.5 \times 10^{12}/\text{cm}^3$ , at what temperature  $T_c^{\text{predict}}$  do you expect the onset of Bose condensation in free space? They claim that they found Bose condensation starting at a temperature of  $T_c^{\text{measured}} = 170 \text{ nK}$ . Is that above or below your estimate? (Useful constants:  $h = 6.6262 \times 10^{-27} \text{ ergs}$ ,  $m_n \sim m_p = 1.6726 \times 10^{-24} \text{ g}$ ,  $k_B = 1.3807 \times 10^{-16} \text{ erg/K}$ .)*

The trap had an effective potential energy that was harmonic in the three directions, but anisotropic with cylindrical symmetry. The frequency along the cylindrical axis was  $f_0 = 120 \text{ Hz}$  so  $\omega_0 \sim 750 \text{ Hz}$ , and the two other frequencies were smaller by a factor of  $\sqrt{8}$ :  $\omega_1 \sim 265 \text{ Hz}$ . The Bose condensation was observed by abruptly removing the trap potential,<sup>49</sup> and letting the gas atoms spread out; the spreading cloud was imaged 60 ms later by shining a laser on them and using a CCD to image the shadow.



**Fig. 7.16 Bose–Einstein condensation** at 400, 200, and 50 nano-Kelvin. The pictures are spatial distributions 60 ms after the potential is removed; the field of view of each image is  $200 \mu\text{m} \times 270 \mu\text{m}$ . The left picture is roughly spherically symmetric, and is taken before Bose condensation; the middle has an elliptical Bose condensate superimposed on the spherical thermal background; the right picture is nearly pure condensate. From [4]. Thanks to the Physics 2000 team for permission to reprint this figure.

For your convenience, the ground state of a particle of mass  $m$  in a one-dimensional harmonic oscillator with frequency  $\omega$  is  $\psi_0(x) = (m\omega/\pi\hbar)^{1/4} e^{-m\omega x^2/2\hbar}$ , and the momentum-space wavefunction is  $\tilde{\psi}_0(p) = (1/(\pi m\hbar\omega))^{1/4} e^{-p^2/2m\hbar\omega}$ . In this 3D problem the solution is a product of the corresponding Gaussians along the three axes.

- (c) *Will the momentum distribution be broader along the high-frequency axis ( $\omega_0$ ) or one of the low-frequency axes ( $\omega_1$ )? Assume that you may ignore the small width in the initial position distribution, and that the positions in Fig. 7.16 reflect the velocity distribution times the time elapsed. Which axis,  $x$  or  $y$  in Fig. 7.16, corresponds to the high-frequency cylinder axis? What anisotropy does one expect in the momentum distribution at high temperatures (classical statistical mechanics)?*

Their Bose condensation is not in free space; the atoms are in a harmonic oscillator potential. In the calculation in free space, we approximated the quantum states as a continuum density of states  $g(E)$ . That is only sensible if  $k_B T$  is large compared to the level spacing near the ground state.

- (d) *Compare  $\hbar\omega$  to  $k_B T$  at the Bose con-*

<sup>49</sup>Actually, they first slowly reduced it by a factor of 75 and then abruptly reduced it from there; let us ignore that complication.

densation point  $T_c^{\text{measured}}$  in their experiment. ( $\hbar = 1.05459 \times 10^{-27}$  erg s;  $k_B = 1.3807 \times 10^{-16}$  erg/K.)

For bosons in a one-dimensional harmonic oscillator of frequency  $\omega_0$ , it is clear that  $g(E) = 1/(\hbar\omega_0)$ ; the number of states in a small range  $\Delta E$  is the number of  $\hbar\omega_0$ s it contains.

(e) Compute the density of single-particle eigenstates

$$g(E) = \int_0^\infty d\varepsilon_1 d\varepsilon_2 d\varepsilon_3 g_1(\varepsilon_1)g_2(\varepsilon_2)g_3(\varepsilon_3) \times \delta(E - (\varepsilon_1 + \varepsilon_2 + \varepsilon_3)) \quad (7.88)$$

for a three-dimensional harmonic oscillator, with one frequency  $\omega_0$  and two of frequency  $\omega_1$ . Show that it is equal to  $1/\delta E$  times the number of states in  $\vec{\varepsilon}$ -space between energies  $E$  and  $E + \delta E$ . Is the thickness of this triangular slab equal to  $\delta E$ ?

Their experiment has  $N = 2 \times 10^4$  atoms in the trap as it condenses.

(f) By working in analogy with the calculation in free space, find the maximum number of atoms that can occupy the three-dimensional harmonic oscillator potential in part (e) without Bose condensation at temperature  $T$ . (You will want to know  $\int_0^\infty z^2/(e^z - 1) dz = 2\zeta(3) = 2.40411$ .) According to your calculation, at what temperature  $T_c^{\text{HO}}$  should the real experimental trap have Bose condensed?

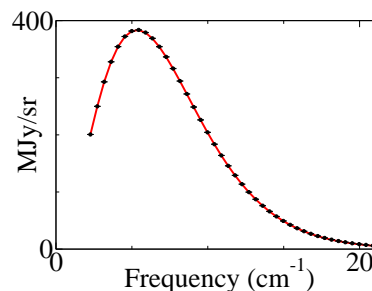
(7.15) **The photon-dominated Universe.**<sup>50</sup> (Astrophysics) ③

The Universe is currently not in equilibrium. However, in the microwave frequency range it is filled with radiation that is precisely described by a Planck distribution at  $2.725 \pm 0.001$  K (Fig. 7.17).

The microwave background radiation is a window back to the *decoupling time*, about 380 000 years after the Big Bang,<sup>51</sup> when the temperature dropped low enough for the protons and electrons to combine into hydrogen atoms. Light does not travel far in ionized gases; it accelerates the charges and scatters from them. Hence, before this time, our Universe was very close to an equilibrium soup of electrons, nuclei, and photons.<sup>52</sup> The neutral atoms after this time were

transparent enough that almost all of the photons traveled for the next 13 billion years directly into our detectors.

These photons in the meantime have greatly increased in wavelength. This is due to the subsequent expansion of the Universe. The initial Planck distribution of photons changed both because of the Doppler effect (a red-shift because the distant gas that emitted the photon appears to be moving away from us) and because the photons are diluted into a larger volume. The Doppler shift both reduces the photon energy and squeezes the overall frequency range of the photons (increasing the number of photons per unit frequency).



**Fig. 7.17 Planck microwave background radiation**, as measured by the COBE satellite [42]. The units on the axes are those used in the original paper: inverse centimeters instead of frequency (related by the speed of light) on the horizontal axis and Mega-Janskys/steradian for the vertical axis (1 MegaJansky =  $10^{-20}$  W m<sup>-2</sup> Hz<sup>-1</sup>). The curve is the Planck distribution at 2.725 K.

One might ask why the current microwave background radiation is thermal (Fig. 7.17), and why it is at such a low temperature . . .

(a) If the side of the box  $L$  and the wavelengths of the photons in the box are all increased by a factor  $f$ , what frequency  $\omega'$  will result from a photon with initial frequency  $\omega$ ? If the original density of photons is  $n(\omega)$ , what is the density of photons  $n'(\omega')$  after the expansion? Show that Planck's form for the number of photons per unit frequency per unit volume

$$\frac{\omega^2}{\pi^2 c^3 (e^{\hbar\omega/k_B T} - 1)} \quad (7.89)$$

<sup>50</sup>This exercise was developed with the help of Dale Fixsen and Eanna Flanagan.

<sup>51</sup>Numbers quoted were reasonable estimates when the exercise was written. See also [143] for a history of the early Universe.

<sup>52</sup>The neutrinos fell out of equilibrium somewhat earlier.

(from eqn 7.66) is preserved, except for a shift in temperature. What is the new temperature  $T'$ , in terms of the original temperature  $T$  and the expansion factor  $f$ ?

This is as expected; an adiabatic expansion leaves the system in equilibrium, but at a different temperature.

(b) How many microwave background photons are there per cubic centimeter? How does this compare to the average atomic density in the Universe ( $n_{\text{matter}} \sim 2.5 \times 10^{-7}$  atoms/cm<sup>3</sup>)? (Note  $\int_0^\infty x^2/(e^x - 1) dx = 2\zeta(3) \approx 2.404$ . Useful constants:  $\hbar = 1.05 \times 10^{-27}$  erg s,  $c = 3 \times 10^{10}$  cm/s, and  $k_B = 1.38 \times 10^{-16}$  erg/K.)

Cosmologists refer to the current Universe as *photon dominated*, because there are currently many more photons than atoms.

We can also roughly estimate the relative contributions of photons and atoms to other properties of the Universe.

(c) Calculate formulae for the entropy  $S$ , the internal energy  $E$ , and the pressure  $P$  for the photon gas in a volume  $V$  and temperature  $T$ . For simplicity, write them in terms of the Stefan–Boltzmann constant<sup>53</sup>  $\sigma = \pi^2 k_B^4/60\hbar^3 c^2$ . Ignore the zero-point energy in the photon modes<sup>54</sup> (which otherwise would make the energy and pressure infinite, even at zero temperature).

(Hint: You will want to use the grand free energy  $\Phi$  for the photons. For your information,  $\int_0^\infty x^3/(e^x - 1) dx = \pi^4/15 = -3 \int_0^\infty x^2 \log(1 - e^{-x}) dx$ , where the last integral can be integrated by parts to get the first integral.)

(d) Calculate formulae for the entropy, mass-energy<sup>55</sup> density, and pressure for an ideal gas of hydrogen atoms at density  $n_{\text{matter}}$  and the same volume and temperature. Can we ignore quantum mechanics for the atomic gas? Assemble your results from parts (c) and (d) into a table comparing photons to atoms, with four columns giving the two analytical formulae and then numerical values for  $V = 1 \text{ cm}^3$ , the current microwave background temperature, and the current atom density. Which are dominated by photons? By atoms? (Hint: You will want to use the Helmholtz free energy  $A$  for

the atoms. More useful constants:  $\sigma = 5.67 \times 10^{-5}$  erg cm<sup>-2</sup> K<sup>-4</sup> s<sup>-1</sup>, and  $m_H \approx m_p = 1.673 \times 10^{-24}$  g.)

Before the decoupling time, the coupled light-and-matter soup satisfied a wave eqn [60]:

$$\rho \frac{\partial^2 \Theta}{\partial t^2} = B \nabla^2 \theta. \tag{7.90}$$

Here  $\Theta$  represents the local temperature fluctuation  $\Delta T/T$ . The constant  $\rho$  is the sum of three contributions: the matter density, the photon energy density  $E/V$  divided by  $c^2$ , and a contribution  $P/c^2$  due to the photon pressure  $P$  (this comes in as a component in the stress-energy tensor in general relativity).

(e) Show that the sum of the two photon contributions to the mass density is proportional to  $E/(c^2 V)$ . What is the constant of proportionality?

The constant  $B$  in our wave eqn 7.90 is the bulk modulus:  $B = -V(\partial P/\partial V)|_S$ .<sup>56</sup> At decoupling, the dominant contribution to the pressure (and to  $B$ ) comes from the photon gas.

(f) Write  $P$  as a function of  $S$  and  $V$  (eliminating  $T$  and  $E$ ), and calculate  $B$  for the photon gas. Show that it is proportional to the photon energy density  $E/V$ . What is the constant of proportionality?

Let  $R$  be the ratio of  $\rho_{\text{matter}}$  to the sum of the photon contributions to  $\rho$  from part (e).

(g) What is the speed of sound in the Universe before decoupling, as a function of  $R$  and  $c$ ? (Hint: Compare with eqn 10.78 in Exercise 10.1 as a check for your answer to parts (e)–(g).)

Exercise 10.1 and the ripples-in-fluids animation at [137] show how this wave equation explains much of the observed fluctuations in the microwave background radiation.

(7.16) **White dwarfs, neutron stars, and black holes.** (Astrophysics, Quantum) ③

As the energy sources in large stars are consumed, and the temperature approaches zero, the final state is determined by the competition between gravity and the chemical or nuclear energy needed to compress the material.

<sup>53</sup>The Stefan–Boltzmann law says that a black body radiates power  $\sigma T^4$  per unit area, where  $\sigma$  is the Stefan–Boltzmann constant; see Exercise 7.7.

<sup>54</sup>Treat them as bosons (eqn 7.42) with  $\mu = 0$  rather than as harmonic oscillators (eqn 7.23).

<sup>55</sup>That is, be sure to include the  $mc^2$  for the hydrogen atoms into their contribution to the energy density.

<sup>56</sup>The fact that one must compress adiabatically (constant  $S$ ) and not isothermally (constant  $T$ ) is subtle but important (Isaac Newton got it wrong). Sound waves happen too fast for the temperature to equilibrate. Indeed, we can assume at reasonably long wavelengths that there is no heat transport (hence we may use the adiabatic modulus). All this is true both for air and for early-Universe photon gasses.

A simplified model of ordinary stellar matter is a Fermi sea of non-interacting electrons, with enough nuclei to balance the charge. Let us model a white dwarf (or black dwarf, since we assume zero temperature) as a uniform density of  $\text{He}^4$  nuclei and a compensating uniform density of electrons. Assume Newtonian gravity. Assume the chemical energy is given solely by the energy of a gas of non-interacting electrons (filling the levels to the Fermi energy).

(a) *Assuming non-relativistic electrons, calculate the energy of a sphere with  $N$  zero-temperature non-interacting electrons and radius  $R$ .<sup>57</sup> Calculate the Newtonian gravitational energy of a sphere of  $\text{He}^4$  nuclei of equal and opposite charge density. At what radius is the total energy minimized?*

A more detailed version of this model was studied by Chandrasekhar and others as a model for white dwarf stars. Useful numbers:  $m_p = 1.6726 \times 10^{-24}$  g,  $m_n = 1.6749 \times 10^{-24}$  g,  $m_e = 9.1095 \times 10^{-28}$  g,  $\hbar = 1.05459 \times 10^{-27}$  erg s,  $G = 6.672 \times 10^{-8}$  cm<sup>3</sup>/(g s<sup>2</sup>), 1 eV =  $1.60219 \times 10^{-12}$  erg,  $k_B = 1.3807 \times 10^{-16}$  erg/K, and  $c = 3 \times 10^{10}$  cm/s.

(b) *Using the non-relativistic model in part (a), calculate the Fermi energy of the electrons in a white dwarf star of the mass of the Sun,  $2 \times 10^{33}$  g, assuming that it is composed of helium.*

(i) *Compare it to a typical chemical binding energy of an atom. Are we justified in ignoring the electron–electron and electron–nuclear interactions (i.e., chemistry)?* (ii) *Compare it to the temperature inside the star, say  $10^7$  K. Are we justified in assuming that the electron gas is de-*

*generate (roughly zero temperature)?* (iii) *Compare it to the mass of the electron. Are we roughly justified in using a non-relativistic theory?* (iv) *Compare it to the mass difference between a proton and a neutron.*

The electrons in large white dwarf stars are relativistic. This leads to an energy which grows more slowly with radius, and eventually to an upper bound on their mass.

(c) *Assuming extremely relativistic electrons with  $\varepsilon = pc$ , calculate the energy of a sphere of non-interacting electrons. Notice that this energy cannot balance against the gravitational energy of the nuclei except for a special value of the mass,  $M_0$ . Calculate  $M_0$ . How does your  $M_0$  compare with the mass of the Sun, above?*

A star with mass larger than  $M_0$  continues to shrink as it cools. The electrons (see (iv) in part (b) above) combine with the protons, staying at a constant density as the star shrinks into a ball of almost pure neutrons (a *neutron star*, often forming a *pulsar* because of trapped magnetic flux). Recent speculations [107] suggest that the ‘neutronium’ will further transform into a kind of quark soup with many strange quarks, forming a transparent insulating material.

For an even higher mass, the Fermi repulsion between quarks cannot survive the gravitational pressure (the quarks become relativistic), and the star collapses into a black hole. At these masses, general relativity is important, going beyond the purview of this text. But the basic competition, between degeneracy pressure and gravity, is the same.

<sup>57</sup>You may assume that the single-particle eigenstates have the same energies and  $\mathbf{k}$ -space density in a sphere of volume  $V$  as they do for a cube of volume  $V$ ; just like fixed versus periodic boundary conditions, the boundary does not matter to bulk properties.



# Calculation and computation

# 8

Most statistical mechanical systems cannot be solved explicitly.<sup>1</sup> Statistical mechanics does provide general relationships and organizing principles (temperature, entropy, free energy, thermodynamic relations) even when a solution is not available. But there are times when specific answers about specific models or experiments are needed.

There are two basic tools for extracting answers out of statistical mechanics for realistic systems. The first is *simulation*. Sometimes one simply mimics the microscopic theory. For example, a molecular dynamics simulation will move the atoms according to Newton's laws. We will not discuss such methods in this chapter.<sup>2</sup> If one is not interested in the detailed dynamical trajectories of the system, one can use *Monte Carlo* simulation methods to extract the equilibrium properties from a model. We introduce these methods in Section 8.1 in the context of the *Ising model*, the most well-studied of the lattice models in statistical mechanics. The theory underlying the Monte Carlo method is the mathematics of *Markov chains*, which arise in many other applications; we discuss them in Section 8.2.

The second tool is to use *perturbation theory*. For a solvable model, one can calculate the effects of small extra terms; for a complex system one can extrapolate from a limit (like zero or infinite temperature) where its properties are known. Section 8.3 briefly discusses perturbation theory, and the deep connection between its convergence and the existence of *phases*.

## 8.1 The Ising model

Lattice models are a big industry within statistical mechanics. These models have a variable at each site of a regular grid, and a Hamiltonian or evolution law for these variables. Critical phenomena and phase transitions (Chapter 12), lattice QCD<sup>3</sup> and quantum field theories, quantum magnetism and models for high-temperature superconductors, phase diagrams for alloys (Section 8.1.2), the behavior of systems with dirt or disorder, and non-equilibrium systems exhibiting avalanches and crackling noise (Chapter 12) all make important use of lattice models.

In this section, we will introduce the Ising model<sup>4</sup> and three physical systems (among many) to which it has been applied: magnetism, bi-

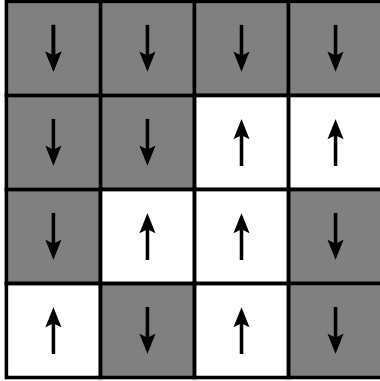
8.1 The Ising model	163
8.2 Markov chains	167
8.3 What is a phase? Perturbation theory	171

<sup>1</sup>No tidy formula for the equation of state, entropy, or partition function can typically be found.

<sup>2</sup>Often direct simulation methods also involve sophisticated ideas from statistical mechanics. For example, to emulate a microscopic system connected to a heat bath, one adds friction and noise to the microscopic theory in the correct proportions so as to lead to proper thermal equilibration (the Einstein relation, eqn 2.22; see also Section 10.8 and Exercise 10.7).

<sup>3</sup>QCD, quantum chromodynamics, is the theory of the strong interaction that binds the nucleus together.

<sup>4</sup>Ising's name is pronounced 'Eesing', but sadly the model is usually pronounced 'Eyesing' with a long I sound.



**Fig. 8.1 The 2D square-lattice Ising model.** It is traditional to denote the values  $s_i = \pm 1$  as up and down, or as two different colors.

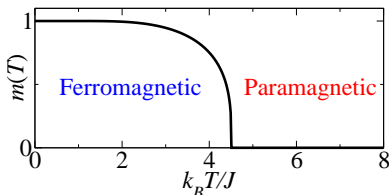
nary alloys, and the liquid–gas transition. The Ising model is the most extensively studied lattice model in physics. Like the ideal gas in the previous chapters, the Ising model will provide a tangible application for many topics to come: Monte Carlo (this section), low- and high-temperature expansions (Section 8.3, Exercise 8.1), relations between fluctuations, susceptibility, and dissipation (Exercises 8.2 and 10.6), nucleation of abrupt transitions (Exercise 11.4), coarsening and phase separation (Section 11.4.1, Exercise 11.6), and self-similarity at continuous phase transitions (Exercise 12.1).

The Ising model has a lattice of  $N$  sites  $i$  with a single, two-state degree of freedom  $s_i$  on each site that may take values  $\pm 1$ . We will be primarily interested in the Ising model on square and cubic lattices (in 2D and 3D, Fig. 8.1). The Hamiltonian for the Ising model is

$$\mathcal{H} = - \sum_{\langle ij \rangle} J s_i s_j - H \sum_i s_i. \tag{8.1}$$

<sup>5</sup>In simulations of finite systems, we will avoid special cases at the edges of the system by implementing *periodic boundary conditions*, where corresponding sites on opposite edges are also neighbors.

Here the sum  $\langle ij \rangle$  is over all pairs of nearest-neighbor sites,<sup>5</sup> and  $J$  is the *coupling* between these neighboring sites. (For example, there are four neighbors per site on the square lattice.)



**Fig. 8.2 Ising magnetization.** The magnetization  $m(T)$  per spin for the 3D cubic lattice Ising model. At low temperatures there is a net magnetization, which vanishes at temperatures  $T > T_c \approx 4.5$ .

### 8.1.1 Magnetism

The Ising model was originally used to describe magnets. Hence the degree of freedom  $s_i$  on each site is normally called a *spin*,  $H$  is called the *external field*, and the sum  $M = \sum_i s_i$  is termed the *magnetization*.

The energy of two neighboring spins  $-J s_i s_j$  is  $-J$  if the spins are parallel, and  $+J$  if they are antiparallel. Thus if  $J > 0$  (the usual case) the model favors parallel spins; we say that the interaction is *ferromagnetic*.<sup>6</sup> At low temperatures, the spins will organize themselves to either mostly point up or mostly point down, forming a *ferromagnetic phase*. If  $J < 0$  we call the interaction *antiferromagnetic*; the spins will tend to align (for our square lattice) in a checkerboard *antiferromagnetic phase* at low temperatures. At high temperatures, independent of the sign of  $J$ , we expect entropy to dominate; the spins will fluctuate wildly in a *paramagnetic phase* and the magnetization per spin  $m(T) = M(T)/N$  is zero (see Fig. 8.2).<sup>7</sup>

<sup>6</sup>‘Ferromagnetic’ is named after iron (Fe), the most common material which has a spontaneous magnetization.

<sup>7</sup>The Ising model parameters are rescaled from the microscopic ones. The Ising spin  $s_i = \pm 1$  represents twice the  $z$ -component of a spin-1/2 atom in a crystal,  $\sigma_i^z = s_i/2$ . The Ising interactions between spins,  $J s_i s_j = 4J \sigma_i^z \sigma_j^z$ , is thus shifted by a factor of four from the  $z$ - $z$  coupling between spins. The coupling of the spin to the external magnetic field is microscopically  $g \mu_B H \cdot \sigma_i^z$ , where  $g$  is the gyromagnetic ratio for the spin (close to two for the electron) and  $\mu_B = e\hbar/2m_e$  is the Bohr magneton. Hence the Ising external field is rescaled from the physical one by  $g\mu_B/2$ . Finally, the interaction between spins in most materials is not so anisotropic as to only involve the  $z$ -component of the spin; it is usually better approximated by the dot product  $\sigma_i \cdot \sigma_j = \sigma_i^x \sigma_j^x + \sigma_i^y \sigma_j^y + \sigma_i^z \sigma_j^z$ , used in the more realistic *Heisenberg model*. (Unlike the Ising model, where  $\sigma_i^z$  commutes with  $\mathcal{H}$  and the spin configurations are the energy eigenstates, the quantum and classical Heisenberg models differ.) Some materials have anisotropic crystal structures which make the Ising model at least approximately valid.



### 8.1.2 Binary alloys

The Ising model is quite a convincing model for binary alloys. Imagine a square lattice of atoms, which can be either of type  $A$  or  $B$  (Fig. 8.3). (A realistic alloy might mix roughly half copper and half zinc to make  $\beta$ -brass. At low temperatures, the copper and zinc atoms each sit on a cubic lattice, with the zinc sites in the middle of the copper cubes, together forming an ‘antiferromagnetic’ phase on the body-centered cubic (bcc) lattice. At high temperatures, the zincs and coppers freely interchange, analogous to the Ising paramagnetic phase.) The transition temperature is about  $733^\circ\text{C}$  [147, section 3.11]. We set the spin values  $A = +1$  and  $B = -1$ . Let the number of the two kinds of atoms be  $N_A$  and  $N_B$ , with  $N_A + N_B = N$ , let the interaction energies (bond strengths) between two neighboring atoms be  $E_{AA}$ ,  $E_{BB}$ , and  $E_{AB}$ , and let the total number of nearest-neighbor bonds of the three possible types be  $N_{AA}$ ,  $N_{BB}$  and  $N_{AB}$ . Then the Hamiltonian for our binary alloy is

$$\mathcal{H}_{\text{binary}} = -E_{AA}N_{AA} - E_{BB}N_{BB} - E_{AB}N_{AB}. \quad (8.2)$$

Since each site interacts only with its nearest neighbors, this must be the Ising model in disguise. Indeed, one finds<sup>8</sup>  $J = \frac{1}{4}(E_{AA} + E_{BB} - 2E_{AB})$  and  $H = E_{AA} - E_{BB}$ .

To make this a quantitative model, one must include atomic relaxation effects. (Surely if one kind of atom is larger than the other, it will push neighboring atoms off their sites. We simply include this relaxation into the energies in our Hamiltonian 8.2.) We must also incorporate thermal position fluctuations into the Hamiltonian, making it a free energy.<sup>9</sup> More elaborate Ising models (with three-site and longer-range interactions, for example) are commonly used to compute realistic phase diagrams for alloys [149]. Sometimes, though, the interactions introduced by relaxations and thermal fluctuations have important long-range pieces, which can lead to qualitative changes in the behavior—for example, they can change the transition from continuous to abrupt.

<sup>8</sup>Check this yourself. Adding an overall shift  $-CN$  to the Ising Hamiltonian, one can see that

$$\mathcal{H}_{\text{Ising}} = -J \sum_{\langle ij \rangle} s_i s_j - H \sum_i s_i - CN = -J(N_{AA} + N_{BB} - N_{AB}) - H(N_A - N_B) - CN, \quad (8.3)$$

since  $N_A - N_B$  corresponds to the net magnetization,  $N_{AA} + N_{BB}$  is the number of parallel neighbors, and  $N_{AB}$  is the number of antiparallel neighbors. Now, use the facts that on a square lattice there are twice as many bonds as spins ( $N_{AA} + N_{BB} + N_{AB} = 2N$ ), and that for every  $A$  atom there must be four bonds ending in an  $A$  ( $4N_A = 2N_{AA} + N_{AB}$ , and similarly  $4N_B = 2N_{BB} + N_{AB}$ ). Solve for and remove  $N$ ,  $N_A$ , and  $N_B$  from the Hamiltonian, and rearrange into the binary alloy form (eqn 8.2); you should find the values for  $J$  and  $H$  above and  $C = \frac{1}{2}(E_{AA} + E_{BB} + 2E_{AB})$ .

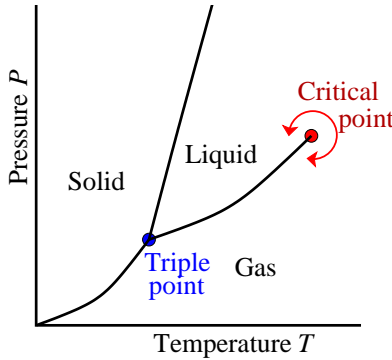
<sup>9</sup>To incorporate thermal fluctuations, we must do a partial trace, integrating out the vibrations of the atoms around their equilibrium positions (as in Section 6.6). This leads to an effective free energy for each pattern of lattice occupancy  $\{s_i\}$ :

$$\mathcal{F}\{s_i\} = -k_B T \log \left( \int d\mathbb{P} \int_{\text{atom } r_i \text{ of type } s_i \text{ near site } i} d\mathbb{Q} \frac{e^{-\mathcal{H}(\mathbb{P}, \mathbb{Q})/k_B T}}{h^{3N}} \right) = \mathcal{H}\{s_i\} - TS\{s_i\}. \quad (8.4)$$

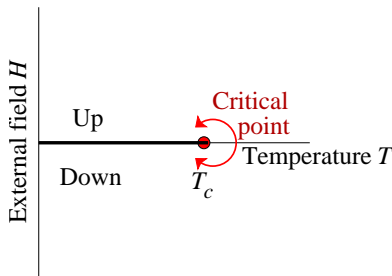
The entropy  $S\{s_i\}$  due to these vibrations will depend upon the particular atomic configuration  $s_i$ , and can often be calculated explicitly (Exercise 6.11(b)).  $\mathcal{F}\{s_i\}$  can now be used as a lattice Hamiltonian, except with temperature-dependent coefficients; those atomic configurations with more freedom to vibrate will have larger entropy and will be increasingly favored at higher temperature.

$B$	$B$	$B$	$B$
$B$	$B$	$A$	$A$
$B$	$A$	$A$	$B$
$A$	$B$	$A$	$B$

**Fig. 8.3** The Ising model as a binary alloy. Atoms in crystals naturally sit on a lattice. The atoms in alloys are made up of different elements (here, types  $A$  and  $B$ ) which can arrange in many configurations on the lattice.



**Fig. 8.4**  $P$ - $T$  phase diagram for a typical material. The solid-liquid phase boundary corresponds to a change in symmetry, and cannot end. The liquid-gas phase boundary typically does end; one can go continuously from the liquid phase to the gas phase by increasing the pressure above  $P_c$ , increasing the temperature above  $T_c$ , and then lowering the pressure again.



**Fig. 8.5**  $H$ - $T$  phase diagram for the Ising model. Below the critical temperature  $T_c$ , there is an up-spin and a down-spin ‘phase’ separated by a jump in magnetization at  $H = 0$ . Above  $T_c$  the behavior is smooth as a function of  $H$ .

<sup>10</sup>This is a typical homework exercise in a textbook like ours; with a few hints, you can do it too.

<sup>11</sup>Or do high-temperature expansions, low-temperature expansions, transfer-matrix methods, exact diagonalization of small systems,  $1/N$  expansions in the number of states per site,  $4 - \epsilon$  expansions in the dimension of space, ...

<sup>12</sup>Monte Carlo is a gambling center in Monaco. Lots of random numbers are generated there.

### 8.1.3 Liquids, gases, and the critical point

The Ising model is also used as a model for the liquid-gas transition. In this *lattice gas* interpretation, up-spins ( $s_i = +1$ ) count as atoms and down-spins count as a site without an atom. The gas is the phase with mostly down-spins (negative ‘magnetization’), with only a few up-spin atoms in the vapor. The liquid phase is mostly atoms (up-spins), with a few vacancies.

The Ising model description of the gas phase seems fairly realistic. The liquid, however, seems much more like a crystal, with atoms sitting on a regular lattice. Why do we suggest that this model is a good way of studying transitions between the liquid and gas phase?

Unlike the binary alloy problem, the Ising model is not a good way to get quantitative phase diagrams for fluids. What it is good for is to understand the properties near the *critical point*. As shown in Fig. 8.4, one can go continuously between the liquid and gas phases; the phase boundary separating them ends at a critical point  $T_c, P_c$ , above which the two phases blur together seamlessly, with no jump in the density separating them.

The Ising model, interpreted as a lattice gas, also has a line  $H = 0$  along which the density (magnetization) jumps, and a temperature  $T_c$  above which the properties are smooth as a function of  $H$  (the paramagnetic phase). The phase diagram in Fig. 8.5 looks only topologically like the real liquid-gas coexistence line in Fig. 8.4, but the behavior near the critical point in the two systems is remarkably similar. Indeed, we will find in Chapter 12 that in many ways the behavior at the liquid-gas critical point is described *exactly* by the three-dimensional Ising model.

### 8.1.4 How to solve the Ising model

How do we solve for the properties of the Ising model?

- (1) Solve the one-dimensional Ising model, as Ising did.<sup>10</sup>
- (2) Have an enormous brain. Onsager solved the two-dimensional Ising model in a bewilderingly complicated way. Since Onsager, many great minds have found simpler, elegant solutions, but all would take at least a chapter of rather technical and unilluminating manipulations to duplicate. Nobody has solved the three-dimensional Ising model.
- (3) Perform the Monte Carlo method on the computer.<sup>11</sup>

The Monte Carlo<sup>12</sup> method involves doing a kind of random walk through the space of lattice configurations. We will study these methods in great generality in Section 8.2. For now, let us just outline the heat-bath Monte Carlo method.

#### Heat-bath Monte Carlo for the Ising model

- Pick a site  $i = (x, y)$  at random.

- Check how many neighbor spins are pointing up:

$$m_i = \sum_{j:(ij)} s_j = \begin{cases} 4 & (4 \text{ neighbors up}), \\ 2 & (3 \text{ neighbors up}), \\ 0 & (2 \text{ neighbors up}), \\ -2 & (1 \text{ neighbor up}), \\ -4 & (0 \text{ neighbors up}). \end{cases} \quad (8.5)$$

- Calculate  $E_+ = -Jm_i - H$  and  $E_- = +Jm_i + H$ , the energy for spin  $i$  to be  $+1$  or  $-1$  given its current environment.
- Set spin  $i$  up with probability  $e^{-\beta E_+} / (e^{-\beta E_+} + e^{-\beta E_-})$  and down with probability  $e^{-\beta E_-} / (e^{-\beta E_+} + e^{-\beta E_-})$ .
- Repeat.

The heat-bath algorithm just thermalizes one spin at a time; it sets the spin up or down with probability given by the thermal distribution given that its neighbors are fixed. Using it, we can explore statistical mechanics with the Ising model on the computer, just as we have used pencil and paper to explore statistical mechanics with the ideal gas.

## 8.2 Markov chains

The heat-bath Monte Carlo algorithm is not the most efficient (or even the most common) algorithm for equilibrating the Ising model. Monte Carlo methods in general are examples of *Markov chains*. In this section we develop the mathematics of Markov chains and provide the criteria needed to guarantee that a given algorithm converges to the equilibrium state.

Markov chains are an advanced topic which is not necessary for the rest of this text. Our discussion does introduce the idea of *detailed balance* and further illustrates the important concept of ergodicity. Markov methods play important roles in other topics (in ways we will not pursue here). They provide the mathematical language for studying random walks and other random evolution laws in discrete and continuum systems. Also, they have become important in bioinformatics and speech recognition, where one attempts to deduce the *hidden Markov model* which describes the patterns and relations in speech or the genome.

In this chapter, we will consider Markov chains with a finite set of states  $\{\alpha\}$ , through which the system evolves in a discrete series of steps  $n$ .<sup>13</sup> The probabilities of moving to different new states in a Markov chain depend *only* on the current state. In general, systems which lack memory of their history are called *Markovian*.

For example, an  $N$ -state Ising model has  $2^N$  states  $\mathbb{S} = \{s_i\}$ . A Markov chain for the Ising model has a transition rule, which at each step shifts the current state  $\mathbb{S}$  to a state  $\mathbb{S}'$  with probability  $P_{\mathbb{S}' \leftarrow \mathbb{S}}$ .<sup>14</sup> For the heat-bath algorithm,  $P_{\mathbb{S}' \leftarrow \mathbb{S}}$  is equal to zero unless  $\mathbb{S}'$  and  $\mathbb{S}$  are the same except for at most one spin flip. There are many problems

<sup>13</sup>There are analogues of Markov chains which have an infinite number of states, and/or are continuous in time and/or space.

<sup>14</sup>Some texts will order the subscripts in the opposite direction  $P_{\mathbb{S} \Rightarrow \mathbb{S}'}$ . We use this convention to make our time evolution correspond to multiplication on the left by  $P_{\alpha\beta}$  (eqn 8.6).

outside of mainstream statistical mechanics that can be formulated in this general way. For example, Exercise 8.4 discusses a model with 1001 states (different numbers  $\alpha$  of red bacteria), and transition rates  $P_{\alpha+1\leftarrow\alpha}$ ,  $P_{\alpha-1\leftarrow\alpha}$ , and  $P_{\alpha\leftarrow\alpha}$ .

Let the probabilities of being in various states  $\alpha$  at step  $n$  be arranged in a vector  $\rho_\alpha(n)$ . Then the rates  $P_{\beta\alpha}$  for moving from  $\alpha$  to  $\beta$  (dropping the arrow) form a matrix, which when applied to the probability vector  $\rho$  takes it from one time to the next (eqn 8.6).

In general, we want to understand the probability of finding different states after long times. Under what circumstances will an algorithm, defined by our matrix  $P$ , take our system into thermal equilibrium? To study this, we need to understand some properties of the transition matrix  $P$ , its eigenvalues, and its eigenvectors.  $P_{\beta\alpha}$  in general must have the following properties.

- **Time evolution.** The probability vector at step  $n + 1$  is

$$\rho_\beta(n + 1) = \sum_\alpha P_{\beta\alpha}\rho_\alpha(n), \quad \rho(n + 1) = P \cdot \rho(n). \quad (8.6)$$

- **Positivity.** The matrix elements are probabilities, so

$$0 \leq P_{\beta\alpha} \leq 1. \quad (8.7)$$

- **Conservation of probability.** The state  $\alpha$  must go somewhere, so

$$\sum_\beta P_{\beta\alpha} = 1. \quad (8.8)$$

- **Not symmetric!** Typically  $P_{\beta\alpha} \neq P_{\alpha\beta}$ .

This last point is not a big surprise; it should be much more likely to go from a high-energy state to a low one than from low to high. However, this asymmetry means that much of our mathematical intuition and many of our tools, carefully developed for symmetric and Hermitian matrices, will not apply to our transition matrix  $P_{\alpha\beta}$ . In particular, we cannot assume in general that we can diagonalize our matrix.

What do we know about the Markov chain and its asymmetric matrix  $P$ ? We will outline the relevant mathematics, proving what is convenient and illuminating and simply asserting other truths.

It is true that our matrix  $P$  will have eigenvalues. Also, it is true that for each distinct eigenvalue there will be at least one right eigenvector:<sup>15</sup>

$$P \cdot \rho^\lambda = \lambda \rho^\lambda \quad (8.9)$$

and one left eigenvector:

$$\sigma^{\lambda\top} \cdot P = \lambda \sigma^{\lambda\top}. \quad (8.10)$$

However, for degenerate eigenvalues there may not be multiple eigenvectors, and the left and right eigenvectors usually will not be equal to one another.<sup>16</sup>

<sup>15</sup>For example, the matrix  $\begin{pmatrix} 0 & 1 \\ 0 & 0 \end{pmatrix}$  has a double eigenvalue of zero, but only one left eigenvector  $(0 \ 1)$  and one right eigenvector  $\begin{pmatrix} 1 \\ 0 \end{pmatrix}$  with eigenvalue zero.

<sup>16</sup>This follows from a more specific theorem that we will not prove. A general matrix  $M$  can be put into *Jordan canonical form* by a suitable change of basis  $S$ :  $M = SJS^{-1}$ . (No connection with the canonical ensemble.) The matrix  $J$  is block diagonal, with one eigenvalue  $\lambda$  associated with each block (but perhaps multiple blocks per  $\lambda$ ). A single block for an eigenvalue  $\lambda$  with multiplicity three would be

$$\begin{pmatrix} \lambda & 1 & 0 \\ 0 & \lambda & 1 \\ 0 & 0 & \lambda \end{pmatrix}. \quad (8.11)$$

The block has only one left and right eigenvector (proportional to the first column and last row).

For the particular case of our transition matrix  $P$ , we can go further. If our Markov chain reaches an equilibrium state  $\rho^*$  at long times, that state must be unchanged under the time evolution  $P$ . That is,  $P \cdot \rho^* = \rho^*$ , and thus the equilibrium probability density is a right eigenvector with eigenvalue one. We can show that our Markov chain transition matrix  $P$  has such a right eigenvector.

**Theorem 8.1** *The matrix  $P$  has at least one right eigenvector  $\rho^*$  with eigenvalue one.*

**Proof** (sneaky)  $P$  has a left eigenvector  $\sigma^*$  with eigenvalue one—the vector all of whose components are one,  $\sigma^{*\top} = (1, 1, 1, \dots, 1)$ :

$$(\sigma^{*\top} \cdot P)_\alpha = \sum_\beta \sigma_\beta^* P_{\beta\alpha} = \sum_\beta P_{\beta\alpha} = 1 = \sigma_\alpha^*. \quad (8.12)$$

Hence  $P$  must have an eigenvalue equal to one, and hence it must also have a right eigenvector with eigenvalue one.  $\square$

We can also show that all the other eigenvalues have right eigenvectors that sum to zero, since  $P$  conserves probability.<sup>17</sup>

**Theorem 8.2** *Any right eigenvector  $\rho^\lambda$  with eigenvalue  $\lambda$  different from one must have components that sum to zero.*

**Proof**  $\rho^\lambda$  is a right eigenvector,  $P \cdot \rho^\lambda = \lambda \rho^\lambda$ . Hence

$$\begin{aligned} \lambda \sum_\beta \rho_\beta^\lambda &= \sum_\beta (\lambda \rho_\beta^\lambda) = \sum_\beta \left( \sum_\alpha P_{\beta\alpha} \rho_\alpha^\lambda \right) = \sum_\alpha \left( \sum_\beta P_{\beta\alpha} \right) \rho_\alpha^\lambda \\ &= \sum_\alpha \rho_\alpha^\lambda. \end{aligned} \quad (8.13)$$

This implies that either  $\lambda = 1$  or  $\sum_\alpha \rho_\alpha^\lambda = 0$ .  $\square$

Markov chains can have more than one stationary probability distribution.<sup>18</sup> They can have *transient* states, which the system eventually leaves, never to return.<sup>19</sup> They can also have *cycles*, which are probability distributions which, like a clock  $1 \rightarrow 2 \rightarrow 3 \rightarrow \dots \rightarrow 12 \rightarrow 1$ , shift through a finite number of distinct classes of states before returning to the original one. All of these are obstacles in our quest for finding the equilibrium states in statistical mechanics. We can bypass all of them by studying *ergodic* Markov chains.<sup>20</sup> A finite-state Markov chain is ergodic if it does not have cycles and it is *irreducible*: that is, one can get from every state  $\alpha$  to every other state  $\beta$  in a finite sequence of moves.

We use the following famous theorem, without proving it here.

**Theorem 8.3. (Perron–Frobenius theorem)** *Let  $A$  be a matrix with all non-negative matrix elements such that  $A^n$  has all positive elements. Then  $A$  has a positive eigenvalue  $\lambda_0$ , of multiplicity one, whose corresponding right and left eigenvectors have all positive components. Furthermore any other eigenvalue  $\lambda$  of  $A$  must be smaller,  $|\lambda| < \lambda_0$ .*

<sup>17</sup>One can also view Theorem 8.2 as saying that all the right eigenvectors except  $\rho^*$  are orthogonal to the left eigenvector  $\sigma^*$ .

<sup>18</sup>A continuum example of this is given by the KAM theorem of Exercise 4.4. There is a probability density confined to each KAM torus which is time independent.

<sup>19</sup>Transient states are important in dissipative dynamical systems, where they consist of all states not on the attractors.

<sup>20</sup>We are compromising here between the standard Markov chain usage in physics and in mathematics. Physicists usually ignore cycles, and call algorithms which can reach every state ergodic. Mathematicians use the term ergodic to exclude cycles and exclude probability running to infinity (not important here, where we have a finite number of states). However, they allow ergodic chains to have transient states; only the ‘attractor’ need be connected. Our definition of ergodic for finite Markov chains corresponds to a transition matrix  $P$  for which some power  $P^n$  has all positive (non-zero) matrix elements; mathematicians call such matrices *regular*.

For an ergodic Markov chain, we can use Theorem 8.2 to see that the Perron–Frobenius eigenvector with all positive components must have eigenvalue  $\lambda_0 = 1$ . We can rescale this eigenvector to sum to one, proving that an ergodic Markov chain has a unique time-independent probability distribution  $\rho^*$ .

What is the connection between our definition of ergodic Markov chains and our earlier definition of ergodic (Section 4.2) involving trajectories in phase space? Ergodic in phase space meant that we eventually come close to all states on the energy surface. For finite Markov chains, ergodic is the stronger condition that we have non-zero probability of getting between any two states in the chain after some finite time.<sup>21</sup>

<sup>21</sup>Note that any algorithm that has a finite probability for each state to remain unchanged ( $P_{\alpha\alpha} > 0$  for all states) is automatically free of cycles; clocks which can lose time will always eventually get out of synchrony.

It is possible to show that an ergodic Markov chain will take any initial probability distribution  $\rho(0)$  and converge to equilibrium, but the proof in general is rather involved. We can simplify it by specializing one more time, to Markov chains that satisfy *detailed balance*.

A Markov chain satisfies *detailed balance* if there is some probability distribution  $\rho^*$  such that<sup>22</sup>

$$P_{\alpha\beta}\rho_{\beta}^* = P_{\beta\alpha}\rho_{\alpha}^* \quad (8.14)$$

<sup>22</sup>There is an elegant equivalent definition of detailed balance directly in terms of  $P$  and not involving the equilibrium probability distribution  $\rho^*$ ; see Exercise 8.5.

for each state  $\alpha$  and  $\beta$ . In words, the probability flux from state  $\alpha$  to  $\beta$  (the rate times the probability of being in  $\alpha$ ) balances the probability flux back, in detail (i.e., for every pair of states).

If an isolated physical system is time-reversal invariant (no dissipation, no magnetic fields), and its states are also invariant under time-reversal (no states with specified velocities or momenta) then its dynamics automatically satisfy detailed balance. This is true because the equilibrium state is also the equilibrium state under time reversal, so the probability flow from  $\beta \rightarrow \alpha$  must equal the time-reversed flow from  $\alpha \rightarrow \beta$ . Quantum systems undergoing transitions between energy eigenstates in perturbation theory usually satisfy detailed balance, since the eigenstates are time-reversal invariant. Many models (like the Ising binary alloy in Section 8.1.2) have states involving only configurational degrees of freedom; these models again satisfy detailed balance.

Detailed balance allows us to find a complete set of right eigenvectors for our transition matrix  $P$ . One can see this with a simple transformation. If we divide both sides of eqn 8.14 by  $\sqrt{\rho_{\beta}^*\rho_{\alpha}^*}$ , we create a symmetric matrix  $Q_{\alpha\beta}$ :

$$\begin{aligned} Q_{\alpha\beta} &= P_{\alpha\beta} \sqrt{\frac{\rho_{\beta}^*}{\rho_{\alpha}^*}} = P_{\alpha\beta} \rho_{\beta}^* / \sqrt{\rho_{\alpha}^*\rho_{\beta}^*} \\ &= P_{\beta\alpha} \rho_{\alpha}^* / \sqrt{\rho_{\alpha}^*\rho_{\beta}^*} = P_{\beta\alpha} \sqrt{\frac{\rho_{\alpha}^*}{\rho_{\beta}^*}} = Q_{\beta\alpha}. \end{aligned} \quad (8.15)$$

<sup>23</sup>This works in reverse to get the right eigenvectors of  $P$  from  $Q$ . One multiplies  $\tau_{\alpha}^{\lambda}$  by  $\sqrt{\rho_{\alpha}^*}$  to get  $\rho_{\alpha}^{\lambda}$ , and divides to get  $\sigma_{\alpha}^{\lambda}$ , so if detailed balance holds,  $\sigma_{\alpha}^{\lambda} = \rho_{\alpha}^{\lambda} / \rho_{\alpha}^*$ . In particular,  $\sigma^1 = \sigma^* = (1, 1, 1, \dots)^{\top}$ , as we saw in Theorem 8.1.

This particular symmetric matrix has eigenvectors  $Q \cdot \tau^{\lambda} = \lambda \tau^{\lambda}$  which can be turned into right eigenvectors of  $P$  when rescaled<sup>23</sup> by  $\sqrt{\rho^*}$ :

$$\rho_{\alpha}^{\lambda} = \tau_{\alpha}^{\lambda} \sqrt{\rho_{\alpha}^*}; \quad (8.16)$$

$$\begin{aligned} \sum_{\alpha} P_{\beta\alpha} \rho_{\alpha}^{\lambda} &= \sum_{\alpha} P_{\beta\alpha} (\tau_{\alpha}^{\lambda} \sqrt{\rho_{\alpha}^*}) = \sum_{\alpha} \left( Q_{\beta\alpha} \sqrt{\frac{\rho_{\beta}^*}{\rho_{\alpha}^*}} \right) (\tau_{\alpha}^{\lambda} \sqrt{\rho_{\alpha}^*}) \\ &= \sum_{\alpha} (Q_{\beta\alpha} \tau_{\alpha}^{\lambda}) \sqrt{\rho_{\beta}^*} = \lambda (\tau_{\beta}^{\lambda} \sqrt{\rho_{\beta}^*}) = \lambda \rho_{\beta}^{\lambda}. \end{aligned} \quad (8.17)$$

Now we turn to the main theorem underlying the algorithms for equilibrating lattice models in statistical mechanics.

**Theorem 8.4. (main theorem)** *A discrete dynamical system with a finite number of states can be guaranteed to converge to an equilibrium distribution  $\rho^*$  if the computer algorithm*

- is Markovian (has no memory),
- is ergodic (can reach everywhere and is acyclic), and
- satisfies detailed balance.

**Proof** Let  $P$  be the transition matrix for our algorithm. Since the algorithm satisfies detailed balance,  $P$  has a complete set of eigenvectors  $\rho^{\lambda}$ . Since our algorithm is ergodic there is only one right eigenvector  $\rho^1$  with eigenvalue one, which we can choose to be the stationary distribution  $\rho^*$ ; all the other eigenvalues  $\lambda$  have  $|\lambda| < 1$ . Decompose the initial condition  $\rho(0) = a_1 \rho^* + \sum_{|\lambda| < 1} a_{\lambda} \rho^{\lambda}$ . Then<sup>24</sup>

$$\rho(n) = P \cdot \rho(n-1) = P^n \cdot \rho(0) = a_1 \rho^* + \sum_{|\lambda| < 1} a_{\lambda} \lambda^n \rho^{\lambda}. \quad (8.18)$$

Since the (finite) sum in this equation decays to zero, the density converges to  $a_1 \rho^*$ . This implies both that  $a_1 = 1$  and that our system converges to  $\rho^*$  as  $n \rightarrow \infty$ .  $\square$

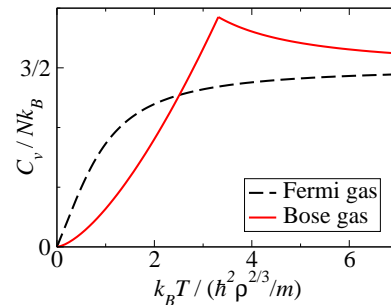
Thus, to develop a new equilibration algorithm (Exercises 8.6, 8.8), one need only ensure that it is Markov, ergodic, and satisfies detailed balance.

### 8.3 What is a phase? Perturbation theory

What is a phase? We know some examples. Water is a liquid phase, which at atmospheric pressure exists between 0°C and 100°C; the equilibrium density of H<sub>2</sub>O jumps abruptly downward when the water freezes or vaporizes. The Ising model is ferromagnetic below  $T_c$  and paramagnetic above  $T_c$ . Figure 8.6 plots the specific heat of a non-interacting gas of fermions and of bosons. There are many differences between fermions and bosons illustrated in this figure,<sup>25</sup> but the fundamental difference is that *the Bose gas has two different phases*. The specific heat has a cusp at the Bose condensation temperature, which separates the normal phase and the condensed phase.

How do we determine in general how far a phase extends? Inside phases the properties do not shift in a singular way; one can smoothly

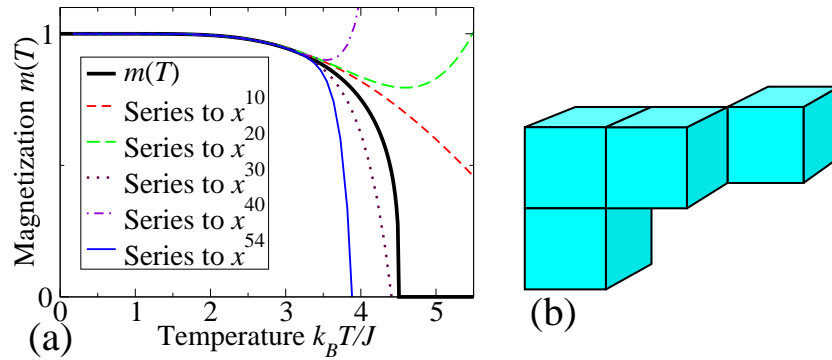
<sup>24</sup>The eigenvectors closest to one will be the slowest to decay. You can get the slowest characteristic time  $\tau$  for a Markov chain by finding the largest  $|\lambda_{\max}| < 1$  and setting  $\lambda^n = e^{-n/\tau}$ .



**Fig. 8.6 Bose and Fermi specific heats.** The specific heats for the ideal Bose and Fermi gases. Notice the cusp at the Bose condensation temperature  $T_c$ . Notice that the specific heat of the Fermi gas shows no such transition.

<sup>25</sup>The specific heat of the Fermi gas falls as the temperature decreases; at low temperatures, only those single-particle eigenstates within a few  $k_B T$  of the Fermi energy can be excited. The specific heat of the Bose gas initially grows as the temperature decreases from infinity. Both the Fermi and Bose gases have  $C_v/N \rightarrow 0$  as  $T \rightarrow 0$ , as is always true (otherwise the entropy,  $\int_0^T C_v/T dT$  would diverge).

**Fig. 8.7 Perturbation theory.** (a) Low-temperature expansions for the cubic Ising model magnetization (Fig. 8.2) with successively larger numbers of terms. (b) The high- and low-temperature expansions for the Ising and other lattice models are sums over (Feynman diagram) clusters. At low  $T$ , Ising configurations are small clusters of up-spins in a background of down-spins (or vice versa). This cluster of four sites on the cubic lattice contributes to the term of order  $x^{20}$  in eqn 8.19, because flipping the cluster breaks 20 bonds.



extrapolate the behavior inside a liquid or magnetic phase under small changes in external conditions. *Perturbation theory works inside phases.* More precisely, inside a phase the properties are analytic (have convergent Taylor expansions) as functions of the external conditions.

Much of statistical mechanics (and indeed of theoretical physics) is devoted to calculating high-order perturbation theories around special solvable limits. (We will discuss *linear* perturbation theory in space and time in Chapter 10.) Lattice theories at high and low temperatures  $T$  have perturbative expansions in powers of  $1/T$  and  $T$ , with Feynman diagrams involving all ways of drawing clusters of lattice points (Fig. 8.7(b)). Gases at high temperatures and low densities have *virial expansions*. Metals at low temperatures have *Fermi liquid theory*, where the electron–electron interactions are perturbatively incorporated by dressing the electrons into quasiparticles. Properties of systems near continuous phase transitions can be explored by perturbing in the dimension of space, giving the  $\epsilon$ -*expansion*. Some of these perturbation series have zero radius of convergence; they are *asymptotic series* (see Exercise 1.5).

For example the low-temperature expansion [35, 103] of the magnetization per spin of the cubic-lattice three-dimensional Ising model (Section 8.1) starts out [17]

$$\begin{aligned}
 m = & 1 - 2x^6 - 12x^{10} + 14x^{12} - 90x^{14} + 192x^{16} - 792x^{18} + 2148x^{20} \\
 & - 7716x^{22} + 23262x^{24} - 79512x^{26} + 252054x^{28} \\
 & - 846628x^{30} + 2753520x^{32} - 9205800x^{34} \\
 & + 30371124x^{36} - 101585544x^{38} + 338095596x^{40} \\
 & - 1133491188x^{42} + 3794908752x^{44} - 12758932158x^{46} \\
 & + 42903505303x^{48} - 144655483440x^{50} \\
 & + 488092130664x^{52} - 1650000819068x^{54} + \dots, \quad (8.19)
 \end{aligned}$$

<sup>26</sup>This heroic calculation (27 terms) was not done to get really accurate low-temperature magnetizations. Various clever methods can use these expansions to extrapolate to understand the subtle phase transition at  $T_c$  (Chapter 12). Indeed, the  $m(T)$  curve shown in both Figs 8.2 and 8.7(a) was not measured directly, but was generated using a 9, 10 Padé approximant [34].

where  $x = e^{-2J/k_B T}$  is the probability to break a bond (parallel energy  $-J$  to antiparallel energy  $+J$ ).<sup>26</sup> This series was generated by carefully considering the probabilities of low-energy spin configurations, formed

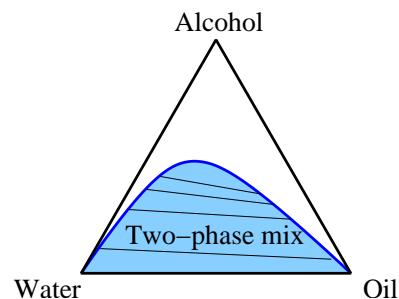


by flipping combinations of clusters of spins (Fig. 8.7(b)). This expansion smoothly predicts the magnetization at low temperatures using the properties at zero temperature; in Fig. 8.7(a) we see that the magnetization is well described by our series for  $k_B T \lesssim 3J$ . Another power series about  $T \sim 3J/k_B$  would converge up to a higher temperature.<sup>27</sup> No finite power series, however, can extrapolate past the temperature  $T_c$  at which the magnetization goes to zero. This is easiest to see in the opposite direction;  $m(T) \equiv 0$  above  $T_c$ , so any extrapolation below  $T_c$  must continue to have zero magnetization. Much of the glory in perturbation theory involves summing infinite families of terms to extrapolate through critical points.

Phase boundaries occur at parameter values where the properties are not smooth—where the continuation of the properties on one side does not predict the behavior on the other. We could almost define phases as regions where perturbation theory works—except for the awkward problem that we do not want liquids and gases to be called part of the same fluid ‘phase’, even though they are connected by paths going around the critical point (Fig. 8.4).

This leads to an important experimental method. Suppose you have invented a new exotic liquid crystal. How can you tell if it is in an already known phase? You look for an experimental path, mixing materials and changing external conditions, for smoothly changing your phase to the known one. For example, are oil and water both in the same (liquid) phase? Can we go from one to the other smoothly, without passing through a phase transition?<sup>28</sup> You cannot mix oil and water, but you can mix oil and alcohol, and certainly can mix alcohol and water. Changing the concentrations smoothly starting from oil, going through pure alcohol, and ending at water demonstrates that these two fluids are part of the same phase (see Fig. 8.8). This is often used, for example, to determine to which exotic phase a new liquid crystal should be assigned. This argument is also the basis for much of theoretical physics. If you can go smoothly from A (your theory) to B (the experiment) by adding corrections, then A and B are in the same phase; publish!<sup>29</sup>

<sup>27</sup>The radius of convergence of the series is less than  $T_c$  because there is another closer singularity in the *complex temperature plane*. This is analogous to the function  $1/(1+x^2)$ , which is smooth on the real axis but whose Taylor series  $1 - x^2 + x^4 - x^6 + \dots$  converges only for  $-1 < x < 1$ ; the poles at  $\pm i$  set the radius of convergence even though the function is analytic for all real  $x$ .



**Fig. 8.8 Oil, water, and alcohol.** A schematic ternary phase diagram for mixtures of oil, water, and alcohol. Each point in the triangle represents a mixture of percentages of the three, with the corners being pure water, oil, and alcohol. The shaded region shows where phase separation occurs; relative concentrations in the shaded region will separate into a two-phase mixture given by the endpoints of the tie-line passing through that point. Oil and water basically do not dissolve in one another; a mixture of the two will separate into the two separate fluids. You can go smoothly from one to the other, though, by first adding alcohol.

<sup>28</sup>This process is sometimes called *adiabatic continuity* [7]. Phases can also be thought of as universality classes for attracting renormalization-group fixed points; see Chapter 12.

<sup>29</sup>Some unperturbed theories are better than others, even if they are in the same phase. The correct theory of superconductors is due to Bardeen, Cooper, and Schrieffer (BCS), despite the fact that earlier theories involving Bose condensation of electron pairs are not separated from BCS theory by a phase transition. The Cooper pairs in most superconductors are large compared to their separation, so they overlap many other pairs and make BCS theory almost exact.

## Exercises

The *Ising model* introduces the continuous and abrupt phase transitions in the model as temperature and field are varied. *Ising fluctuations and susceptibilities* introduces the linear response of the model to external fields, the connection between fluctuations and response, and the energy gap and Curie law at low and high temperatures.

*Coin flips and Markov chains* and *Red and green bacteria* give examples of non-equilibrium Markov chains. *Detailed balance* derives a formulation of this basic transition rate relation that does not presume an equilibrium probability distribution. *Metropolis* explores the most commonly applied Monte Carlo method, and in *Implementing Ising* you write your own heat-bath and Metropolis algorithms. *Wolff* and *Implementing Wolff* analyze a powerful and subtle cluster-flip algorithm.

In small systems like biological cells, the numbers of reacting molecules can be so small that number fluctuations can be important; *Stochastic cells* and *The repressilator* develop Monte Carlo methods (the Gillespie algorithm) for stochastic simulations of chemical reactions in these systems. In *Entropy increases! Markov chains* you show that the coarse-grained description of a system with a Markov chain does decrease the free energy with time.

In *Hysteresis and avalanches* we introduce a non-equilibrium lattice model describing magnets, and in *Hysteresis algorithms* we explore a modern  $O(N \log N)$  algorithm for evolving the model. Finally, in *NP-completeness and satisfiability*, we explore the most challenging class of problems in computer science, and find a phase transition at which the truly difficult cases congregate.

### (8.1) The Ising model. (Computation) ①

You will need a two-dimensional square-lattice Ising model simulation, one of which is available among the computational exercises section on the book web site [129]. The Ising Hamiltonian is (eqn 8.1):

$$\mathcal{H} = -J \sum_{\langle ij \rangle} S_i S_j - H \sum_i S_i, \quad (8.20)$$

where  $S_i = \pm 1$  are ‘spins’ on a square lattice, and the sum  $\sum_{\langle ij \rangle}$  is over the four nearest-neighbor bonds (each pair summed once). It is conventional to set the coupling strength  $J = 1$  and Boltzmann’s constant  $k_B = 1$ , which amounts to measuring energies and temperatures in units of  $J$ . The constant  $H$  is called the

external field, and  $\mathbf{M} = \sum_i S_i$  is called the magnetization. Our simulation does not conserve the number of spins up, so it is not a natural simulation for a binary alloy. You can think of it as a grand canonical ensemble, or as a model for extra atoms on a surface exchanging with the vapor above.

Play with the simulation. At high temperatures, the spins should not be strongly correlated. At low temperatures the spins should align all parallel, giving a large magnetization.

*Roughly locate  $T_c$ , the largest temperature where distant spins remain parallel on average at  $T = 0$ . Explore the behavior by gradually lowering the temperature from just above  $T_c$  to just below  $T_c$ ; does the behavior gradually change, or jump abruptly (like water freezing to ice)? Explore the behavior at  $T = 2$  (below  $T_c$ ) as you vary the external field  $H = \pm 0.1$  up and down through the ‘phase boundary’ at  $H = 0$  (Fig. 8.5). Does the behavior vary smoothly in that case?*

### (8.2) Ising fluctuations and susceptibilities. (Computation) ③

The partition function for the Ising model is  $Z = \sum_n \exp(-\beta E_n)$ , where the states  $n$  run over all  $2^N$  possible configurations of the Ising spins (eqn 8.1), and the free energy  $F = -kT \log Z$ .

(a) *Show that the average of the magnetization  $M$  equals  $-(\partial F / \partial H)|_T$ . (Hint: Write out the sum for the partition function and take the derivative.) Derive the formula for the susceptibility  $\chi_0 = (\partial M / \partial H)|_T$  in terms of  $\langle (M - \langle M \rangle)^2 \rangle = \langle M^2 \rangle - \langle M \rangle^2$ . (Hint: Remember our derivation of formula 6.13  $\langle (E - \langle E \rangle)^2 \rangle = k_B T^2 C$ .)*

Download an Ising model simulation from the computational exercises section of the book web site [129]. Notice that the program outputs averages of several quantities:  $\langle |m| \rangle$ ,  $\langle (m - \langle m \rangle)^2 \rangle$ ,  $\langle e \rangle$ ,  $\langle (e - \langle e \rangle)^2 \rangle$ . In simulations, it is standard to measure  $e = E/N$  and  $m = M/N$  per spin (so that the plots do not depend upon system size); you will need to rescale properties appropriately to make comparisons with formulæ written for the energy and magnetization of the *system as a whole*. You can change the system size and decrease the graphics refresh rate (number of



sweeps per draw) to speed your averaging. Make sure to equilibrate before starting to average!

(b) Correlations and susceptibilities: numerical. Check the formulæ for  $C$  and  $\chi$  from part (a) at  $H = 0$  and  $T = 3$ , by measuring the fluctuations and the averages, and then changing by  $\Delta H = 0.02$  or  $\Delta T = 0.1$  and measuring the averages again. Check them also for  $T = 2$ , where  $\langle M \rangle \neq 0$ .<sup>30</sup>

There are systematic series expansions for the Ising model at high and low temperatures, using Feynman diagrams (see Section 8.3). The first terms of these expansions are both famous and illuminating.

*Low-temperature expansion for the magnetization.* At low temperatures we can assume all spins flip alone, ignoring clusters.

(c) What is the energy for flipping a spin antiparallel to its neighbors? Equilibrate at a relatively low temperature  $T = 1.0$ , and measure the magnetization. Notice that the primary excitations are single spin flips. In the low-temperature approximation that the flipped spins are dilute (so we may ignore the possibility that two flipped spins touch or overlap), write a formula for the magnetization. (Remember, each flipped spin changes the magnetization by 2.) Check your prediction against the simulation. (Hint: See eqn 8.19.)

The magnetization (and the specific heat) are exponentially small at low temperatures because there is an energy gap to spin excitations in the Ising model,<sup>31</sup> just as there is a gap to charge excitations in a semiconductor or an insulator.

*High-temperature expansion for the susceptibility.* At high temperatures, we can ignore the coupling to the neighboring spins.

(d) Calculate a formula for the susceptibility of a free spin coupled to an external field. Compare it to the susceptibility you measure at high temperature  $T = 100$  for the Ising model, say,  $\Delta M/\Delta H$  with  $\Delta H = 1$ . (Why is  $H = 1$  a small

field in this case?)

Your formula for the high-temperature susceptibility is known more generally as Curie's law.

(8.3) **Coin flips and Markov.** (Mathematics) ②

A physicist, testing the laws of chance, flips a coin repeatedly until it lands tails.

(a) Treat the two states of the physicist ('still flipping' and 'done') as states in a Markov chain. The current probability vector then is  $\vec{\rho} = \begin{pmatrix} \rho_{\text{flipping}} \\ \rho_{\text{done}} \end{pmatrix}$ . Write the transition matrix  $\mathcal{P}$ , giving the time evolution  $\mathcal{P} \cdot \vec{\rho}_n = \vec{\rho}_{n+1}$ , assuming that the coin is fair.

(b) Find the eigenvalues and right eigenvectors of  $\mathcal{P}$ . Which eigenvector is the steady state  $\rho^*$ ? Call the other eigenvector  $\tilde{\rho}$ . For convenience, normalize  $\tilde{\rho}$  so that its first component equals one.

(c) Assume an arbitrary initial state is written  $\rho_0 = A\rho^* + B\tilde{\rho}$ . What are the conditions on  $A$  and  $B$  needed to make  $\rho_0$  a valid probability distribution? Write  $\rho_n$  as a function of  $A$ ,  $B$ ,  $\rho^*$ , and  $\tilde{\rho}$ .

(8.4) **Red and green bacteria.**<sup>32</sup> (Mathematics) ②

A growth medium at time  $t = 0$  has 500 red bacteria and 500 green bacteria. Each hour, each bacterium divides in two. A color-blind predator eats exactly 1000 bacteria per hour.<sup>33</sup>

(a) After a very long time, what is the probability distribution for the number  $\alpha$  of red bacteria in the growth medium?

(b) Roughly how long will it take to reach this final state?<sup>34</sup>

(c) Assume that the predator has a 1% preference for green bacteria (implemented as you choose). Roughly how much will this change the final distribution?

<sup>30</sup>Be sure to wait until the state is equilibrated before you start! Below  $T_c$  this means the state should not have red and black 'domains', but be all in one ground state. You may need to apply a weak external field for a while to remove stripes at low temperatures.

<sup>31</sup>Not all real magnets have a gap; if there is a spin rotation symmetry, one can have gapless *spin waves*, which are like sound waves except twisting the magnetization rather than wiggling the atoms.

<sup>32</sup>Adapted from author's graduate preliminary exam, Princeton University, fall 1977.

<sup>33</sup>This question is purposely open-ended, and rough answers to parts (b) and (c) within a factor of two are perfectly acceptable. Numerical and analytical methods are both feasible.

<sup>34</sup>Within the accuracy of this question, you may assume either that one bacterium reproduces and then one is eaten 1000 times per hour, or that at the end of each hour all the bacteria reproduce and then 1000 are consumed. The former method is more convenient for analytical work finding eigenvectors; the latter can be used to motivate approaches using the diffusion of probability with an  $\alpha$ -dependent diffusion constant.

(8.5) **Detailed balance.** ②

In an equilibrium system, for any two states  $\alpha$  and  $\beta$  with equilibrium probabilities  $\rho_\alpha^*$  and  $\rho_\beta^*$ , detailed balance states (eqn 8.14) that

$$P_{\beta \leftarrow \alpha} \rho_\alpha^* = P_{\alpha \leftarrow \beta} \rho_\beta^*, \quad (8.21)$$

that is, the equilibrium flux of probability from  $\alpha$  to  $\beta$  is the same as the flux backward from  $\beta$  to  $\alpha$ . It is both possible and elegant to reformulate the condition for detailed balance so that it does not involve the equilibrium probabilities. Consider three states of the system,  $\alpha$ ,  $\beta$ , and  $\gamma$ . (a) Assume that each of the three types of transitions among the three states satisfies detailed balance. Eliminate the equilibrium probability densities to derive

$$P_{\alpha \leftarrow \beta} P_{\beta \leftarrow \gamma} P_{\gamma \leftarrow \alpha} = P_{\alpha \leftarrow \gamma} P_{\gamma \leftarrow \beta} P_{\beta \leftarrow \alpha}. \quad (8.22)$$

Viewing the three states  $\alpha$ ,  $\beta$ , and  $\gamma$  as forming a circle, you have derived a relationship between the rates going clockwise and the rates going counter-clockwise around the circle.

It is possible to show conversely that if every triple of states in a Markov chain satisfies the condition 8.22 then it satisfies detailed balance (that there is at least one probability density  $\rho^*$  which makes the probability fluxes between all pairs of states equal), except for complications arising when some of the rates are zero.

(b) Suppose  $P$  is the transition matrix for some Markov chain satisfying the condition 8.22 for every triple of states  $\alpha$ ,  $\beta$ , and  $\gamma$ . Assume that there is a state  $\alpha$  with non-zero transition rates from all other states  $\delta$ . Construct a probability density  $\rho_\delta^*$  that demonstrates that  $P$  satisfies detailed balance (eqn 8.21). (Hint: If you assume a value for  $\rho_\alpha^*$ , what must  $\rho_\delta^*$  be to ensure detailed balance for the pair? Show that this candidate distribution satisfies detailed balance for any two states.)

(8.6) **Metropolis.** (Mathematics, Computation) ①

The heat-bath algorithm described in the text thermalizes one spin at a time. Another popular choice is the Metropolis algorithm, which also flips a single spin at a time:

- (1) pick a spin at random;
- (2) calculate the energy  $\Delta E$  for flipping the spin;
- (3) if  $\Delta E < 0$  flip it; if  $\Delta E > 0$ , flip it with probability  $e^{-\beta \Delta E}$ .

Show that Metropolis satisfies detailed balance. Note that it is ergodic and Markovian (no memory), and hence that it will lead to thermal equilibrium. Is Metropolis more efficient than the heat-bath algorithm (fewer random numbers needed to get to equilibrium)?

(8.7) **Implementing Ising.** (Computation) ④

In this exercise, we will implement a simulation of the two-dimensional Ising model on a square lattice using the heat-bath and Metropolis algorithms. In the computer exercises portion of the web site for this book [129], you will find some hint files and graphic routines to facilitate working this exercise. The hints file should allow you to animate random square grids of  $\pm 1$ , giving you both the graphics interface and an example of random number generation.

The heat-bath algorithm flips spins one at a time, putting them into equilibrium with their neighbors: it is described in detail in Section 8.1.

(a) Implement the heat-bath algorithm for the Ising model. When the temperature or external field is set, you should also reset the values in an array `heatBathProbUp[nUp]` storing the probability that a spin will be set to +1 given that `nUp` of its neighbors are currently pointing up (equal to +1). (Calculating these probabilities over and over again for millions of spin flips is unnecessary.) Explore the resulting behavior (say, as in Exercise 8.1).

The Metropolis algorithm also flips one spin at a time, but it always flips spins if the net energy decreases: it is described in detail in Exercise 8.6.

(b) Implement the Metropolis algorithm for the Ising model. Here you will want to set up an array `MetropolisProbUp[s,nUp]` storing the probability that a spin which currently has value `s` will be set to +1 if `nUp` of its neighbors are currently up. Is Metropolis noticeably faster than the heat-bath algorithm?

The Metropolis algorithm is always faster to equilibrate than the heat-bath algorithm, but is never a big improvement. Other algorithms can be qualitatively faster in certain circumstances (see Exercises 8.8 and 8.9).

(8.8) **Wolff.** (Mathematics, Computation) ③

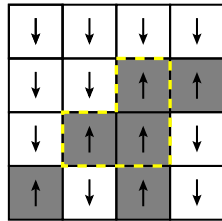
Near the critical point  $T_c$  where the system develops a magnetization, any single-spin-flip dynamics becomes very slow (the correlation time diverges). Wolff [146], improving on ideas of Swendsen and Wang [135], came up with a clever method to flip whole clusters of spins.

Wolff cluster flips

- (1) Pick a spin at random, remember its direction  $D = \pm 1$ , and flip it.
- (2) For each of the four neighboring spins, if it is in the direction  $D$ , flip it with probability  $p$ .
- (3) For each of the new flipped spins, recursively flip their neighbors as in (2).

Because with finite probability you can flip any spin, the Wolff algorithm is ergodic. As a cluster flip it is Markovian. Let us see that it satisfies detailed balance, when we pick the right value of  $p$  for the given temperature.

(a) Show for the configurations in Figs 8.9 and 8.10 that  $E_B - E_A = 2(n_\uparrow - n_\downarrow)J$ . Argue that this will be true for flipping any cluster of up-spins to down-spins.



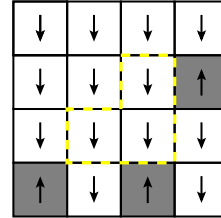
**Fig. 8.9 Cluster flip: before.** The region inside the dotted line is flipped in one Wolff move. Let this configuration be A.

The cluster flip can start at any site  $\alpha$  in the cluster C. The ratio of rates  $\Gamma_{A \rightarrow B} / \Gamma_{B \rightarrow A}$  depends upon the number of times the cluster chose *not* to grow on the boundary. Let  $P_\alpha^C$  be the probability that the cluster grows internally from site  $\alpha$  to the cluster C (ignoring the moves which try to grow outside the boundary). Then

$$\Gamma_{A \rightarrow B} = \sum_{\alpha} P_{\alpha}^C (1 - p)^{n_{\uparrow}}, \quad (8.23)$$

$$\Gamma_{B \rightarrow A} = \sum_{\alpha} P_{\alpha}^C (1 - p)^{n_{\downarrow}}, \quad (8.24)$$

since the cluster must refuse to grow  $n_{\uparrow}$  times when starting from the up-state A, and  $n_{\downarrow}$  times when starting from B.



**Fig. 8.10 Cluster flip: after.** Let this configuration be B. Let the cluster flipped be C. Notice that the boundary of C has  $n_{\uparrow} = 2, n_{\downarrow} = 6$ .

(b) What value of  $p$  lets the Wolff algorithm satisfy detailed balance at temperature  $T$ ?

Unless you plan to implement the Wolff algorithm yourself (Exercise 8.9, download the Wolff simulation from the computer exercises section of the text web site [129]). Run at  $T = 2.3$ , using the heat-bath algorithm for a  $500 \times 500$  system or larger; watch the slow growth of the characteristic cluster sizes. Now change to the Wolff algorithm, and see how much faster the equilibration is. Also notice that many sweeps almost completely rearrange the pattern; the correlation time is much smaller for the Wolff algorithm than for single-spin-flip methods like heat bath and Metropolis. (See [98, sections 4.2–3] for more details on the Wolff algorithm.)

(8.9) **Implementing Wolff.** (Computation) ④

In this exercise, we will implement the Wolff algorithm of Exercise 8.8. In the computer exercises portion of the web site for this book [129], you will find some hint files and graphic routines to facilitate working this exercise.

Near the critical temperature  $T_c$  for a magnet, the equilibration becomes very sluggish: this is called *critical slowing-down*. This sluggish behavior is faithfully reproduced by the single-spin-flip heat-bath and Metropolis algorithms. If one is interested in equilibrium behavior, and not in dynamics, one can hope to use fancier algorithms that bypass this sluggishness, saving computer time.

(a) Run the two-dimensional Ising model (either from the text web site or from your solution to Exercise 8.7) near  $T_c = 2 / \log(1 + \sqrt{2})$  using a single-spin-flip algorithm. Start in a magnetized state, and watch the spins rearrange until roughly half are pointing up. Start at high temperatures, and watch the up- and down-spin regions grow

slowly. Run a large enough system that you get tired of waiting for equilibration.

The Wolff algorithm flips large clusters of spins at one time, largely bypassing the sluggishness near  $T_c$ . It can only be implemented at zero external field. It is described in detail in Exercise 8.8.

(b) *Implement the Wolff algorithm. A recursive implementation works only for small system sizes on most computers. Instead, put the spins that are destined to flip on a list toFlip. You will also need to keep track of the sign of the original triggering spin.*

While there are spins toFlip,

if the first spin remains parallel to the original, flip it, and

for each neighbor of the flipped spin,

if it is parallel to the original spin,

add it to toFlip with probability  $p$ .

(c) *Estimate visually how many Wolff cluster flips it takes to reach the equilibrium state at  $T_c$ . Is Wolff faster than the single-spin-flip algorithms? How does it compare at high temperatures?*

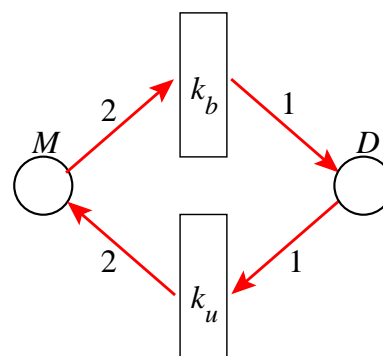
(d) *Starting from a random configuration, change to a low temperature  $T = 1$  and observe the equilibration using a single-spin flip algorithm. Compare with your Wolff algorithm. (See also Exercise 12.3.) Which reaches equilibrium faster? Is the dynamics changed qualitatively, though?*

(8.10) **Stochastic cells.**<sup>35</sup> (Biology, Computation) ④

Living cells are amazingly complex mixtures of a variety of complex molecules (RNA, DNA, proteins, lipids, ...) that are constantly undergoing reactions with one another. This complex of reactions has been compared to computation; the cell gets input from external and internal sensors, and through an intricate series of reactions produces an appropriate response. Thus, for example, receptor cells in the retina 'listen' for light and respond by triggering a nerve impulse.

The kinetics of chemical reactions are usually described using differential equations for the concentrations of the various chemicals, and rarely are statistical fluctuations considered important. In a cell, the numbers of molecules of a given type can be rather small; indeed, there is (often) only one copy of the relevant part of DNA for a given reaction. It is an important question

whether and when we may describe the dynamics inside the cell using continuous concentration variables, even though the actual numbers of molecules are always integers.



**Fig. 8.11 Dimerization reaction.** A Petri net diagram for a dimerization reaction, with dimerization rate  $k_b$  and dimer dissociation rate  $k_u$ .

Consider a dimerization reaction; a molecule  $M$  (called the 'monomer') joins up with another monomer and becomes a dimer  $D$ :  $2M \leftrightarrow D$ . Proteins in cells often form dimers; sometimes (as here) both proteins are the same (homodimers) and sometimes they are different proteins (heterodimers). Suppose the forward reaction rate is  $k_d$  and the backward reaction rate is  $k_u$ . Figure 8.11 shows this as a Petri net [50] with each reaction shown as a box, with incoming arrows showing species that are consumed by the reaction, and outgoing arrows showing species that are produced by the reaction; the number consumed or produced (the *stoichiometry*) is given by a label on each arrow. There are thus two reactions: the backward unbinding reaction rate per unit volume is  $k_u[D]$  (each dimer disassociates with rate  $k_u$ ), and the forward binding reaction rate per unit volume is  $k_b[M]^2$  (since each monomer must wait for a collision with another monomer before binding, the rate is proportional to the monomer concentration squared).

The brackets  $[\cdot]$  denote concentrations. We assume that the volume per cell is such that one molecule per cell is 1 nM ( $10^{-9}$  moles per liter). For convenience, we shall pick nanomoles as our unit of concentration, so  $[M]$  is also the num-

<sup>35</sup>This exercise and the associated software were developed in collaboration with Christopher Myers.

ber of monomers in the cell. Assume  $k_b = 1 \text{ nM}^{-1}\text{s}^{-1}$  and  $k_u = 2 \text{ s}^{-1}$ , and that at  $t = 0$  all  $N$  monomers are unbound.

(a) Continuum dimerization. Write the differential equation for  $dM/dt$  treating  $M$  and  $D$  as continuous variables. (Hint: Remember that two  $M$  molecules are consumed in each reaction.) What are the equilibrium concentrations for  $[M]$  and  $[D]$  for  $N = 2$  molecules in the cell, assuming these continuous equations and the values above for  $k_b$  and  $k_u$ ? For  $N = 90$  and  $N = 10\,100$  molecules? Numerically solve your differential equation for  $M(t)$  for  $N = 2$  and  $N = 90$ , and verify that your solution settles down to the equilibrium values you found.

For large numbers of molecules in the cell, we expect that the continuum equations may work well, but for just a few molecules there surely will be relatively large fluctuations. These fluctuations are called *shot noise*, named in early studies of electrical noise at low currents due to individual electrons in a resistor. We can implement a Monte Carlo algorithm to simulate this shot noise.<sup>36</sup> Suppose the reactions have rates  $\Gamma_i$ , with total rate  $\Gamma_{\text{tot}} = \sum_i \Gamma_i$ . The idea is that the expected time to the next reaction is  $1/\Gamma_{\text{tot}}$ , and the probability that the next reaction will be  $j$  is  $\Gamma_j/\Gamma_{\text{tot}}$ . To simulate until a final time  $t_f$ , the algorithm runs as follows.

- (1) Calculate a list of the rates of all reactions in the system.
- (2) Find the total rate  $\Gamma_{\text{tot}}$ .
- (3) Pick a random time  $t_{\text{wait}}$  with probability distribution  $\rho(t) = \Gamma_{\text{tot}} \exp(-\Gamma_{\text{tot}} t)$ .
- (4) If the current time  $t$  plus  $t_{\text{wait}}$  is bigger than  $t_f$ , no further reactions will take place; return.
- (5) Otherwise,
  - increment  $t$  by  $t_{\text{wait}}$ ,
  - pick a random number  $r$  uniformly distributed in the range  $[0, \Gamma_{\text{tot}})$ ,
  - pick the reaction  $j$  for which  $\sum_{i < j} \Gamma_i \leq r < \sum_{i < j+1} \Gamma_i$  (that is,  $r$  lands in the  $j$ th interval of the sum forming  $\Gamma_{\text{tot}}$ ),

- execute that reaction, by incrementing each chemical involved by its stoichiometry.

(6) Repeat.

There is one important additional change:<sup>37</sup> the binding reaction rate for  $M$  total monomers binding is no longer  $k_b M^2$  for discrete molecules; it is  $k_b M(M-1)$ .<sup>38</sup>

(b) Stochastic dimerization. Implement this algorithm for the dimerization reaction of part (a). Simulate for  $N = 2$ ,  $N = 90$ , and  $N = 10\,100$  and compare a few stochastic realizations with the continuum solution. How large a value of  $N$  do you need for the individual reactions to be well described by the continuum equations (say, fluctuations less than  $\pm 20\%$  at late times)?

Measuring the concentrations in a single cell is often a challenge. Experiments often average over many cells. Such experiments will measure a smooth time evolution even though the individual cells are noisy. Let us investigate whether this ensemble average is well described by the continuum equations.

(c) Average stochastic dimerization. Find the average of many realizations of your stochastic dimerization in part (b), for  $N = 2$  and  $N = 90$ , and compare with your deterministic solution. How much is the long-term average shifted by the stochastic noise? How large a value of  $N$  do you need for the ensemble average of  $M(t)$  to be well described by the continuum equations (say, shifted by less than 5% at late times)?

#### (8.11) The repressilator.<sup>39</sup> (Biology, Computation) ④

The ‘central dogma’ of molecular biology is that the flow of information is from DNA to RNA to proteins; DNA is *transcribed* into RNA, which then is *translated* into protein.

Now that the genome is sequenced, it is thought that we have the parts list for the cell. All that remains is to figure out how they work together! The proteins, RNA, and DNA form a complex network of interacting chemical reactions, which governs metabolism, responses to external stimuli, reproduction (*proliferation*), *differentiation*

<sup>36</sup>In the context of chemical simulations, this algorithm is named after Gillespie [45]; the same basic approach was used just a bit earlier in the Ising model by Bortz, Kalos, and Lebowitz [19], and is called *continuous-time Monte Carlo* in that context.

<sup>37</sup>Without this change, if you start with an odd number of cells your concentrations can go negative!

<sup>38</sup>Again  $[M] = M$ , because we assume one molecule per cell gives a concentration of 1 nM.

<sup>39</sup>This exercise draws heavily on Elowitz and Leibler [37]; it and the associated software were developed in collaboration with Christopher Myers.

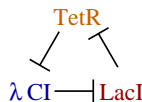


into different cell types, and (when the cell perceives itself to be breaking down in dangerous ways) programmed cell death, or *apoptosis*.

Our understanding of the structure of these interacting networks is growing rapidly, but our understanding of the dynamics is still rather primitive. Part of the difficulty is that the cellular networks are not neatly separated into different modules; a given protein may participate in what would seem to be several separate regulatory pathways. In this exercise, we will study a model gene regulatory network, the *repressilator*. This experimental system involves three proteins, each of which inhibits the formation of the next. They were added to the bacterium *E. coli*, with hopefully minimal interactions with the rest of the biological machinery of the cell. We will implement the stochastic model that the authors used to describe their experimental system [37]. In doing so, we will

- implement in a tangible system an example both of the central dogma and of *transcriptional regulation*: the control by proteins of DNA expression into RNA,
- introduce sophisticated Monte Carlo techniques for simulations of stochastic reactions,
- introduce methods for automatically generating continuum descriptions from reaction rates, and
- illustrate the *shot noise* fluctuations due to small numbers of molecules and the *telegraph noise* fluctuations due to finite rates of binding and unbinding of the regulating proteins.

Figure 8.12 shows the biologist's view of the repressilator network. Three proteins (TetR,  $\lambda$ CI, and LacI) each repress the formation of the next. We shall see that, under appropriate circumstances, this can lead to spontaneous oscillations; each protein peaks in turn, suppressing the suppressor of its suppressor, leading to its own later decrease.



**Fig. 8.12 Biology repressilator.** The biologist's view of the repressilator network. The T-shapes are blunt arrows, signifying that the protein at the tail (bottom of the T) suppresses the production of the protein at the head. Thus LacI (pronounced lack-eye) suppresses TetR (tet-are), which suppresses  $\lambda$  CI (lambda-see-one). This condensed description summarizes a complex series of interactions (see Fig. 8.13).

The biologist's notation summarizes a much more complex picture. The LacI protein, for example, can bind to one or both of the *transcriptional regulation* or *operator* sites ahead of the gene that codes for the tetR mRNA.<sup>40</sup> When bound, it largely blocks the translation of DNA into tetR.<sup>41</sup> The level of tetR will gradually decrease as it degrades; hence less TetR protein will be translated from the tetR mRNA. The resulting network of ten reactions is depicted in Fig. 8.13, showing one-third of the total repressilator network. The biologist's shorthand (Fig. 8.12) does not specify the details of how one protein represses the production of the next. The larger diagram, for example, includes two operator sites for the repressor molecule to bind to, leading to three states ( $P_0$ ,  $P_1$ , and  $P_2$ ) of the promoter region depending upon how many LacI proteins are bound.

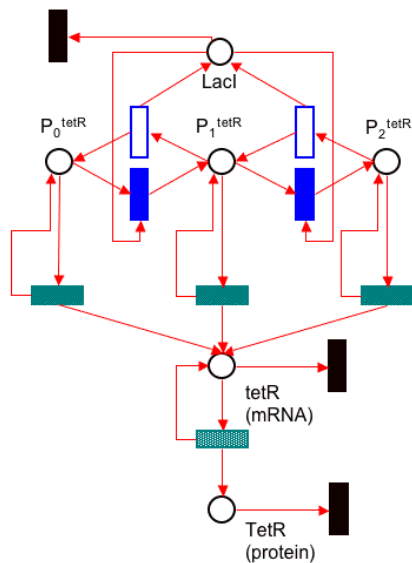
You may retrieve a simulation package for the repressilator from the computational exercises portion of the book web site [129].

(a) Run the simulation for at least 6000 seconds and plot the protein, RNA, and promoter states as a function of time. Notice that

- the protein levels do oscillate, as in [37, figure 1(c)],
- there are significant noisy-looking fluctuations,
- there are many more proteins than RNA.

<sup>40</sup>Messenger RNA (mRNA) codes for proteins. Other forms of RNA can serve as enzymes or parts of the machinery of the cell. Proteins in *E. coli* by convention have the same names as their mRNA, but start with capitals where the mRNA start with small letters.

<sup>41</sup>RNA polymerase, the molecular motor responsible for transcribing DNA into RNA, needs to attach to the DNA at a *promoter site*. By binding to the adjacent operator sites, our repressor protein inhibits this attachment and hence partly blocks transcription. The residual transcription is called 'leakiness'.



**Fig. 8.13 Computational repressilator.**

The Petri net version [50] of *one-third* of the repressilator network (the LacI repression of TetR). The biologist's shorthand (Fig. 8.12) hides a lot of complexity! We have implemented these equations for you, so studying this figure is optional. The solid lighter vertical rectangles represent binding reactions  $A + B \rightarrow C$ , with rate  $k_b[A][B]$ ; the open vertical rectangles represent unbinding  $C \rightarrow A + B$ , with rate  $k_u[C]$ . The horizontal rectangles represent catalyzed synthesis reactions  $C \rightarrow C + P$ , with rate  $\gamma[C]$ ; the darker ones represent transcription (formation of mRNA), and the lighter one represent translation (formation of protein). The black vertical rectangles represent degradation reactions,  $A \rightarrow \text{nothing}$  with rate  $k_d[A]$ . The LacI protein (top) can bind to the DNA in two *promoter sites* ahead of the gene coding for tetR; when bound, it largely blocks the transcription (formation) of tetR mRNA.  $P_0$  represents the promoter without any LacI bound;  $P_1$  represents the promoter with one site blocked, and  $P_2$  represents the doubly-bound promoter. LacI can bind to one or both of the promoter sites, changing  $P_i$  to  $P_{i+1}$ , or correspondingly unbind. The unbound  $P_0$  state transcribes tetR mRNA quickly, and the bound states transcribe it slowly (leaky repression). The tetR mRNA then catalyzes the formation of the TetR protein.

To see how important the fluctuations are, we should compare the stochastic simulation to the solution of the continuum reaction rate equations (as we did in Exercise 8.10). In [37], the authors write a set of six differential equations giving a continuum version of the stochastic simula-

tion. These equations are simplified; they both 'integrate out' or coarse-grain away the promoter states from the system, deriving a Hill equation (Exercise 6.12) for the mRNA production, and they also rescale their variables in various ways. Rather than typing in their equations and sorting out these rescalings, it is convenient and illuminating to write a routine to generate the continuum differential equations directly from our reaction rates.

(b) Write a `DeterministicRepressilator`, derived from `Repressilator` just as `StochasticRepressilator` was. Write a routine `dcdt(c,t)` that does the following.

- Sets the chemical amounts in the reaction network to the values in the array `c`.
- Sets a vector `dcdt` (of length the number of chemicals) to zero.
- For each reaction:
  - compute its rate;
  - for each chemical whose stoichiometry is changed by the reaction, add the stoichiometry change times the rate to the corresponding entry of `dcdt`.

Call a routine to integrate the resulting differential equation (as described in the last part of Exercise 3.12, for example), and compare your results to those of the stochastic simulation.

The stochastic simulation has significant fluctuations away from the continuum equation. Part of these fluctuations are due to the fact that the numbers of proteins and mRNAs are small; in particular, the mRNA numbers are significantly smaller than the protein numbers.

(c) Write a routine that creates a stochastic repressilator network that multiplies the mRNA concentrations by `RNAFactor` without otherwise affecting the continuum equations. (That is, multiply the initial concentrations and the transcription rates by `RNAFactor`, and divide the translation rate by `RNAFactor`.) Try boosting the `RNAFactor` by ten and one hundred. Do the RNA and protein fluctuations become significantly smaller? This noise, due to the discrete, integer values of chemicals in the cell, is analogous to the *shot noise* seen in electrical circuits due to the discrete quantum of electric charge. It scales, as do most fluctuations, as the square root of the number of molecules.

A continuum description of the binding of the proteins to the operator sites on the DNA seems

particularly dubious; a variable that must be zero or one is replaced by a continuous evolution between these extremes. (Such noise in other contexts is called *telegraph noise*—in analogy to the telegraph, which is either silent or sending as the operator taps the key.) The continuum description is accurate in the limit where the binding and unbinding rates are fast compared to all of the other changes in the system; the protein and mRNA variations then see the average, local equilibrium concentration. On the other hand, if the rates are slow compared to the response of the mRNA and protein, the latter can have a switching appearance.

(d) Incorporate a `telegraphFactor` into your stochastic repressilator routine, that multiplies the binding and unbinding rates. Run for 1000 seconds with `RNAFactor` = 10 (to suppress the shot noise) and `telegraphFactor` = 0.001. Do you observe features in the mRNA curves that appear to switch as the relevant proteins unbind and bind?

(8.12) **Entropy increases! Markov chains.** (Mathematics) ③

Convexity arguments are a basic tool in formal statistical mechanics. The function  $f(x) = -x \log x$  is strictly concave (convex downward) for  $x \geq 0$  (Fig. 5.9); this is easily shown by noting that its second derivative is negative in this region.

(a) Convexity for sums of many terms. If  $\sum_{\alpha} \mu_{\alpha} = 1$ , and if for all  $\alpha$  both  $\mu_{\alpha} \geq 0$  and  $x_{\alpha} \geq 0$ , show by induction on the number of states  $M$  that if  $g(x)$  is concave for  $x \geq 0$ , then

$$g\left(\sum_{\alpha=1}^M \mu_{\alpha} x_{\alpha}\right) \geq \sum_{\alpha=1}^M \mu_{\alpha} g(x_{\alpha}). \quad (8.25)$$

This is a generalization of Jensen’s inequality (eqn 5.27), which was the special case of equal  $\mu_{\alpha}$ . (Hint: In the definition of concave,  $f(\lambda a + (1 - \lambda)b) \geq \lambda f(a) + (1 - \lambda)f(b)$ , take  $(1 - \lambda) = \mu_{M+1}$  and  $b = x_{M+1}$ . Then  $a$  is a sum of  $M$  terms, rescaled from their original values. Do the coefficients of  $x_{\alpha}$  in  $a$  sum to one? Can we apply induction?)

In Exercise 5.7 you noticed that, formally speaking, entropy does not increase in Hamiltonian

systems. Let us show that it does increase for Markov chains.<sup>42</sup>

The Markov chain is implicitly exchanging energy with a heat bath at the temperature  $T$ . Thus to show that the entropy for the world as a whole increases, we must show that  $\Delta S - \Delta E/T$  increases, where  $\Delta S$  is the entropy of our system and  $\Delta E/T$  is the entropy flow from the heat bath. Hence, showing that entropy increases for our Markov chain is equivalent to showing that the free energy  $E - TS$  decreases.

Let  $P_{\alpha\beta}$  be the transition matrix for a Markov chain, satisfying detailed balance with energy  $E_{\alpha}$  at temperature  $T$ . The current probability of being in state  $\alpha$  is  $\rho_{\alpha}$ . The free energy

$$F = E - TS = \sum_{\alpha} \rho_{\alpha} E_{\alpha} + k_B T \sum_{\alpha} \rho_{\alpha} \log \rho_{\alpha}. \quad (8.26)$$

(b) Show that the free energy decreases for a Markov chain. In particular, using eqn 8.25, show that the free energy for  $\rho_{\beta}^{(n+1)} = \sum_{\alpha} P_{\beta\alpha} \rho_{\alpha}^{(n)}$  is less than or equal to the free energy for  $\rho^{(n)}$ . You may use the properties of the Markov transition matrix  $P$ , ( $0 \leq P_{\alpha\beta} \leq 1$  and  $\sum_{\alpha} P_{\alpha\beta} = 1$ ), and detailed balance ( $P_{\alpha\beta} \rho_{\beta}^* = P_{\beta\alpha} \rho_{\alpha}^*$ , where  $\rho_{\alpha}^* = \exp(-E_{\alpha}/k_B T)/Z$ ). (Hint: You will want to use  $\mu_{\alpha} = P_{\alpha\beta}$  in eqn 8.25, but the entropy will involve  $P_{\beta\alpha}$ , which is *not* the same. Use detailed balance to convert from one to the other.)

(8.13) **Hysteresis and avalanches.**<sup>43</sup> (Complexity, Computation) ④

A piece of magnetic material exposed to an increasing external field  $H(t)$  (Fig. 8.14) will magnetize (Fig. 8.15) in a series of sharp jumps, or *avalanches* (Fig. 8.16). These avalanches arise as magnetic domain walls in the material are pushed by the external field through a rugged potential energy landscape due to irregularities and impurities in the magnet. The magnetic signal resulting from these random avalanches is called *Barkhausen noise*.

We model this system with a non-equilibrium lattice model, the *random field Ising model*. The Hamiltonian or energy function for our system is

$$\mathcal{H} = - \sum_{\langle i,j \rangle} J s_i s_j - \sum_i (H(t) + h_i) s_i, \quad (8.27)$$

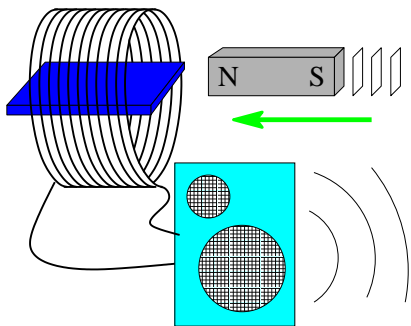
<sup>42</sup>We know that the Markov chain eventually evolves to the equilibrium state, and we argued that the latter minimizes the free energy. What we are showing here is that the free energy goes continuously downhill for a Markov chain.

<sup>43</sup>This exercise is largely drawn from [69]. It and the associated software were developed in collaboration with Christopher Myers.

where the spins  $s_i = \pm 1$  lie on a square or cubic lattice with periodic boundary conditions. The coupling and the external field  $H$  are as in the traditional Ising model (Section 8.1). The disorder in the magnet is incorporated using the *random field*  $h_i$ , which is independently chosen at each lattice site from a Gaussian probability distribution of standard deviation  $R$ :

$$P(h) = \frac{1}{\sqrt{2\pi}R} e^{-h^2/2R^2}. \quad (8.28)$$

We are not interested in thermal equilibrium; there would be no hysteresis! We take the opposite extreme; we set the temperature to zero. We start with all spins pointing down, and adiabatically (infinitely slowly) increase  $H(t)$  from  $-\infty$  to  $\infty$ .

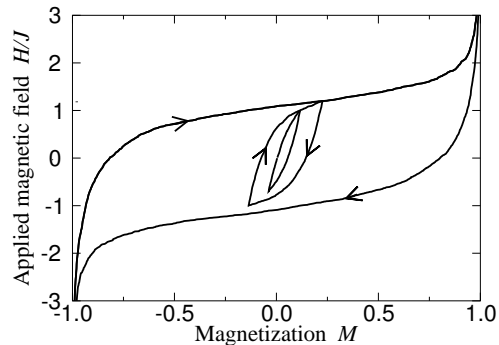


**Fig. 8.14 Barkhausen noise experiment.** By increasing an external magnetic field  $H(t)$  (bar magnet approaching), the magnetic domains in a slab of iron flip over to align with the external field. The resulting magnetic field jumps can be turned into an electrical signal with an inductive coil, and then listened to with an ordinary loudspeaker. Barkhausen noise from our computer experiments can be heard on the Internet [68].

Our rules for evolving the spin configuration are simple: each spin flips over when doing so would decrease the energy. This occurs at site  $i$  when the local field at that site

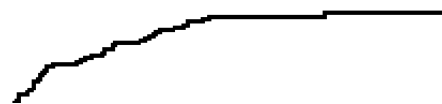
$$J \sum_{j \text{ nbr to } i} s_j + h_i + H(t) \quad (8.29)$$

changes from negative to positive. A spin can be pushed over in two ways. It can be triggered when one of its neighbors flips (by participating in a propagating avalanche) or it can be triggered by the slow increase of the external field (starting a new avalanche).



**Fig. 8.15 Hysteresis loop with subloops** for our model. As the external field is raised and lowered (vertical), the magnetization lags behind—this is called *hysteresis*. The magnetization curves here look macroscopically smooth.

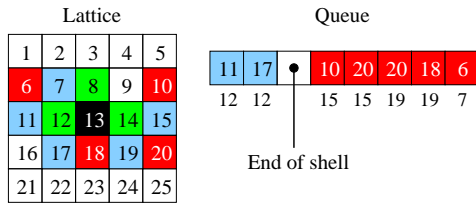
We will provide hints files and graphics routines for different languages and systems on the computer exercises portion of the book web site [129].



**Fig. 8.16 Tiny jumps: Barkhausen noise.** Blowing up a small portion of Fig. 8.15, we see that the magnetization is growing in a series of sharp jumps, or avalanches.

(a) Set up lattices  $s[m][n]$  and  $h[m][n]$  on the computer. (If you do three dimensions, add an extra index to the arrays.) Fill the former with down-spins ( $-1$ ) and the latter with random fields (real numbers chosen from the distribution 8.28). Write a routine `FlipSpin` for the lattice, which given  $i$  and  $j$  flips the spin from  $s = -1$  to  $s = +1$  (complaining if it is already flipped). Write a routine `NeighborsUp` which calculates the number of up-neighbors for the spin (implementing the periodic boundary conditions).

On the computer, changing the external field infinitely slowly is easy. To start a new avalanche (or the first avalanche), one searches for the unflipped spin that is next to flip, jumps the field  $H$  to just enough to flip it, and propagates the avalanche, as follows.

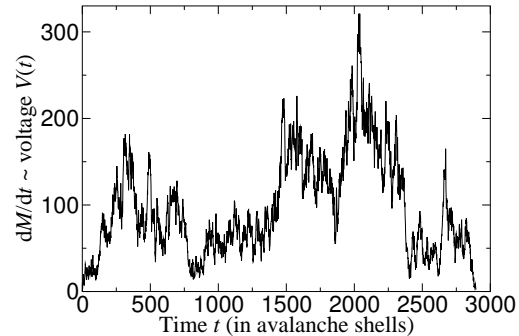


**Fig. 8.17 Avalanche propagation in the hysteresis model.** Left: a propagating avalanche. Spin 13 triggered the avalanche. It triggered the first shell of spins 14, 8, and 12, which then triggered the second shell 15, 19, 7, 11, and 17, and finally the third shell 10, 20, 18, and 6. Right: the first-in-first-out queue, part way through flipping the second shell. (The numbers underneath are the triggering spins for the spins on the queue, for your convenience.) The spin at the left of this queue is next to flip. Notice that spin 20 has been placed on the queue twice (two neighbors in the previous shell). By placing a marker at the end of each shell in the queue, we can measure the number of spins flipping per unit ‘time’ during an avalanche (Fig. 8.18).

#### Propagating an avalanche

- (1) Find the triggering spin  $i$  for the next avalanche, which is the unflipped site with the largest internal field  $J \sum_{j \text{ nbr to } i} s_j + h_i$  from its random field and neighbors.
  - (2) Increment the external field  $H$  to minus this internal field, and push the spin onto a first-in-first-out queue (Fig. 8.17, right).
  - (3) Pop the top spin off the queue.
  - (4) If the spin has not been flipped,<sup>44</sup> flip it and push all unflipped neighbors with positive local fields onto the queue.
  - (5) While there are spins on the queue, repeat from step (3).
  - (6) Repeat from step (1) until all the spins are flipped.
- (b) Write a routine `BruteForceNextAvalanche` for step (1), which checks the local fields of all of the unflipped spins, and returns the location of the next to flip.
- (c) Write a routine `PropagateAvalanche` that propagates an avalanche given the triggering spin, steps (3)–(5), coloring the spins in the display that are flipped. Run a  $300 \times 300$  system at  $R = 1.4, 0.9,$  and  $0.7$  (or a  $50^3$  system at

$R = 4, R = 2.16,$  and  $R = 2$ ) and display the avalanches. If you have a fast machine, you can run a larger size system, but do not overdo it; the sorted list algorithm below will dramatically speed up the simulation.



**Fig. 8.18 Avalanche time series.** Number of domains flipped per time step for the avalanche shown in Fig. 12.5. Notice how the avalanche almost stops several times; if the forcing were slightly smaller compared to the disorder, the avalanche would have separated into smaller ones. The fact that the disorder is just small enough to keep the avalanche growing is the criterion for the phase transition, and the cause of the self-similarity. At the critical point, a partial avalanche of size  $S$  will on average trigger another one of size  $S$ .

There are lots of properties that one might wish to measure about this system: avalanche sizes, avalanche correlation functions, hysteresis loop shapes, average pulse shapes during avalanches, ... It can get ugly if you put all of these measurements inside the inner loop of your code. Instead, we suggest that you try the *subject-observer* design pattern: each time a spin is flipped, and each time an avalanche is finished, the subject (our simulation) notifies the list of observers.

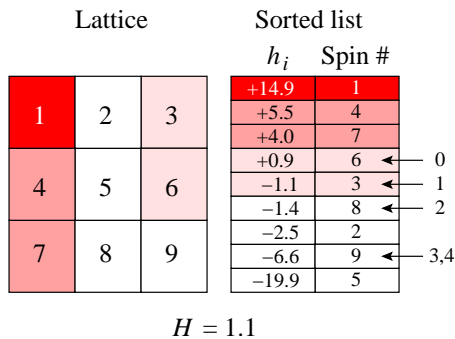
- (d) Build a `MagnetizationObserver`, which stores an internal magnetization starting at  $-N$ , adding two to it whenever it is notified. Build an `AvalancheSizeObserver`, which keeps track of the growing size of the current avalanche after each spin flip, and adds the final size to a histogram of all previous avalanche sizes when the avalanche ends. Set up `NotifySpinFlip` and `NotifyAvalancheEnd` routines for your simula-

<sup>44</sup>You need to check if the spin is flipped again after popping it off the queue; spins can be put onto the queue more than once during an avalanche (Fig. 8.17).

tion, and add the two observers appropriately. Plot the magnetization curve  $M(H)$  and the avalanche size distribution histogram  $D(S)$  for the three systems you ran for part (c).

(8.14) **Hysteresis algorithms.**<sup>45</sup> (Complexity, Computation) ④

As computers increase in speed and memory, the benefits of writing efficient code become greater and greater. Consider a problem on a system of size  $N$ ; a complex algorithm will typically run more slowly than a simple one for small  $N$ , but if its time used scales proportional to  $N$  and the simple algorithm scales as  $N^2$ , the added complexity wins as we can tackle larger, more ambitious questions.



**Fig. 8.19** Using a sorted list to find the next spin in an avalanche. The shaded cells have already flipped. In the sorted list, the arrows on the right indicate the `nextPossible[nUp]` pointers—the first spin that would not flip with `nUp` neighbors at the current external field. Some pointers point to spins that have already flipped, meaning that these spins already have more neighbors up than the corresponding `nUp`. (In a larger system the unflipped spins will not all be contiguous in the list.)

In the hysteresis model (Exercise 8.13), the brute-force algorithm for finding the next avalanche for a system with  $N$  spins takes a time of order  $N$  per avalanche. Since there are roughly  $N$  avalanches (a large fraction of all avalanches are of size one, especially in three dimensions) the time for the brute-force algorithm

scales as  $N^2$ . Can we find a method which does not look through the whole lattice every time an avalanche needs to start?

We can do so using the *sorted list* algorithm: we make<sup>46</sup> a list of the spins in order of their random fields (Fig. 8.19). Given a field range  $(H, H + \Delta)$  in a lattice with  $z$  neighbors per site, only those spins with random fields in the range  $JS + H < -h_i < JS + (H + \delta)$  need to be checked, for the  $z + 1$  possible fields  $JS = (-Jz, -J(z-2), \dots, Jz)$  from the neighbors. We can keep track of the locations in the sorted list of the  $z + 1$  possible next spins to flip. The spins can be sorted in time  $N \log N$ , which is practically indistinguishable from linear in  $N$ , and a big improvement over the brute-force algorithm.

*Sorted list algorithm.*

- (1) Define an array `nextPossible[nUp]`, which points to the location in the sorted list of the next spin that would flip if it had `nUp` neighbors. Initially, all the elements of `nextPossible[nUp]` point to the spin with the largest random field  $h_i$ .
- (2) From the  $z + 1$  spins pointed to by `nextPossible`, choose the one `nUpNext` with the largest internal field in `nUp - nDown + h_i = 2 nUp - z + h_i`. Do not check values of  $h_i = 2 nUp - z + h_i$  for which the pointer has fallen off the end of the list; use a variable `stopNUP`.
- (3) Move the pointer `nextPossible[nUpNext]` to the next spin on the sorted list. If you have fallen off the end of the list, decrement `stopNUP`.<sup>47</sup>
- (4) If the spin `nUpNext` has exactly the right number of up-neighbors, flip it, increment the external field  $H(t)$ , and start the next avalanche. Otherwise go back to step (2).

*Implement the sorted list algorithm for finding the next avalanche. Notice the pause at the beginning of the simulation; most of the computer time ought to be spent sorting the list. Compare*

<sup>45</sup>This exercise is also largely drawn from [69], and was developed with the associated software in collaboration with Christopher Myers.

<sup>46</sup>Make sure you use a packaged routine to sort the list; it is the slowest part of the code. It is straightforward to write your own routine to sort lists of numbers, but not to do it efficiently for large lists.

<sup>47</sup>Either this spin is flipped (move to the next), or it will start the next avalanche (flip and move to the next), or it has too few spins to flip (move to the next, flip it when it has more neighbors up).

the timing with your brute-force algorithm for a moderate system size, where the brute-force algorithm is slightly painful to run. Run some fairly large systems<sup>48</sup> (2000<sup>2</sup> at  $R = (0.7, 0.8, 0.9)$  or 200<sup>3</sup> at  $R = (2.0, 2.16, 3.0)$ ), and explore the avalanche shapes and size distribution.

To do really large simulations of billions of spins without needing gigabytes of memory, there is yet another algorithm we call *bits*, which stores the spins as bits and never generates or stores the random fields (see [69] for implementation details).

(8.15) **NP-completeness and kSAT.**<sup>49</sup> (Computer science, Computation, Mathematics) ④

In this exercise you will numerically investigate a phase transition in an ensemble of problems in mathematical logic, called **kSAT** [8, 93]. In particular, you will examine how the computational difficulty of the problems grows near the critical point. This exercise ties together a number of fundamental issues in critical phenomena, computer science, and mathematical logic.

The **kSAT** problem we study is one in a class of problems called **NP**-complete. In other exercises, we have explored how the speed of algorithms for solving computational problems depends on the size  $N$  of the system. (Sorting a list of  $N$  elements, for example, can be done using of order  $N \log N$  size comparisons between elements.) Computer scientists categorize problems into *complexity classes*; for example, a problem is in **P** if it can guarantee a solution<sup>50</sup> in a time that grows no faster than a polynomial in the size  $N$ . Sorting lists is in **P** (the time grows more slowly than  $N^2$ , for example, since  $N \log N < N^2$  for large  $N$ ); telling whether an  $N$  digit number is prime has recently been shown also to be in **P**. A problem is in **NP**<sup>51</sup> if a proposed solution can be *verified* in polynomial

time. For example, factoring an integer with  $N$  digits is not known to be in **P** (since there is no known algorithm for finding the factors<sup>52</sup> of an  $N$ -digit integer that runs in a time polynomial in  $N$ ), but it is in **NP**.

(a) Given two proposed factors of an  $N$  digit integer, argue that the number of computer operations needed to verify whether their product is correct is less than a constant times  $N^2$ .

There are many problems in **NP** that have no known polynomial-time solution algorithm. A large family of them, the **NP**-complete problems, have been shown to be maximally difficult, in the sense that they can be used to efficiently solve any other problem in **NP**. Specifically, any problem in **NP** can be translated (using an algorithm that runs in time polynomial in the size of the problem) into any one of the **NP**-complete problems, with only a polynomial expansion in the size  $N$ . A polynomial-time algorithm for any one of the **NP**-complete problems would allow one to solve all **NP** problems in polynomial time.

- The *traveling salesman problem* is a classic example. Given  $N$  cities and a cost for traveling between each pair and a budget  $K$ , find a round-trip path (if it exists) that visits each city with cost  $< K$ . The best known algorithm for the traveling salesman problem tests a number of paths that grows exponentially with  $N$ —faster than any polynomial.
- In statistical mechanics, the problem of finding the lowest-energy configuration of a spin glass<sup>53</sup> is also **NP**-complete (Section 12.3.4).
- Another **NP**-complete problem is 3-colorability (Exercise 1.8). Can the  $N$  nodes of a graph be colored red, green, and blue so that no two nodes joined by an edge have the

<sup>48</sup>Warning: You are likely to run out of RAM before you run out of patience. If you hear your disk start swapping (lots of clicking noise), run a smaller system size.

<sup>49</sup>This exercise and the associated software were developed in collaboration with Christopher Myers, with help from Bart Selman and Carla Gomes.

<sup>50</sup>**P** and **NP**-complete are defined for deterministic, single-processor computers. There are polynomial-time algorithms for solving some problems (like prime factorization) on a quantum computer, if we can figure out how to build one.

<sup>51</sup>**NP** does not stand for ‘not polynomial’, but rather for *non-deterministic polynomial* time. **NP** problems can be solved in polynomial time on a hypothetical *non-deterministic* parallel computer—a machine with an indefinite number of CPUs that can be each run on a separate sub-case.

<sup>52</sup>The difficulty of factoring large numbers is the foundation of some of our *public-key cryptography* methods, used for ensuring that your credit card number on the web is available to the merchant without being available to anyone else listening to the traffic. Factoring large numbers is not known to be *NP*-complete.

<sup>53</sup>Technically, as in the traveling salesman problem, we should phrase this as a decision problem. Find a state (if it exists) with energy less than  $E$ .

same color?

One of the key challenges in computer science is determining whether **P** is equal to **NP**—that is, whether all of these problems can be solved in polynomial time. It is generally believed that the answer is negative, that in the worst cases **NP**-complete problems require exponential time to solve.

Proving a new type of problem to be **NP**-complete usually involves translating an existing **NP**-complete problem into the new type (expanding  $N$  at most by a polynomial). In Exercise 1.8, we introduced the problem of determining *satisfiability* (**SAT**) of Boolean logical expressions. Briefly, the **SAT** problem is to find an assignment of  $N$  logical variables (true or false) that makes a given logical expression true, or to determine that no such assignment is possible. A logical expression is made from the variables using the operations OR ( $\vee$ ), AND ( $\wedge$ ), and NOT ( $\neg$ ). We introduced in Exercise 1.8 a particular subclass of logical expressions called **3SAT** which demand simultaneous satisfaction of  $M$  clauses in  $N$  variables each an OR of three literals (where a literal is a variable or its negation). For example, a **3SAT** expression might start out

$$[(\neg X_{27}) \vee X_{13} \vee X_3] \wedge [(\neg X_2) \vee X_{43} \vee (\neg X_{21})] \dots \quad (8.30)$$

We showed in that exercise that **3SAT** is **NP**-complete by translating a general 3-colorability problem with  $N$  nodes into a **3SAT** problem with  $3N$  variables. As it happens, **SAT** was the first problem to be proven to be **NP**-complete; *any* **NP** problem can be mapped onto **SAT** in roughly this way. **3SAT** is also known to be **NP**-complete, but **2SAT** (with clauses of only two literals) is known to be **P**, solvable in polynomial time.

#### *Numerics*

Just because a problem is **NP**-complete does not make a typical instance of the problem numerically challenging. The classification is determined by worst-case scenarios, not by the ensemble of typical problems. If the difficult problems are rare, the average time for solution might be acceptable even though some problems in the ensemble will take exponentially long times to run. (Most coloring problems with a few hundred nodes can be either quickly 3-colored or quickly shown to need four; there exist particular

maps, though, which are fiendishly complicated.) Statistical mechanics methods are used to study the average time and distribution of times for solving these hard problems.

In the remainder of this exercise we will implement algorithms to solve examples of **kSAT** problems, and apply them to the ensemble of random **2SAT** and **3SAT** problems with  $M$  clauses. We will see that, in the limit of large numbers of variables  $N$ , the fraction of satisfiable **kSAT** problems undergoes a *phase transition* as the number  $M/N$  of clauses per variable grows. Each new clause reduces the scope for possible solutions. The random **kSAT** problems with few clauses per variable are almost always satisfiable, and it is easy to find a solution; the random **kSAT** problems with many clauses per variable are almost always not satisfiable, and it is easy to find a contradiction. Only near the critical point where the mean number of solutions vanishes as  $N \rightarrow \infty$  is determining satisfiability typically a challenge.

A logical expression in conjunctive normal form with  $N$  variables  $X_m$  can conveniently be represented on the computer as a list of sublists of non-zero integers in the range  $[-N, N]$ , with each integer representing a literal ( $-m$  representing  $\neg X_m$ ) each sublist representing a disjunction (OR) of its literals, and the list as a whole representing the conjunction (AND) of its sublists. Thus  $[[-3, 1, 2], [-2, 3, -1]]$  would be the expression  $((\neg X_3) \vee X_1 \vee X_2) \wedge ((\neg X_2) \vee X_3 \vee (\neg X_1))$ .

Download the hints and animation software from the computer exercises portion of the text web site [129].

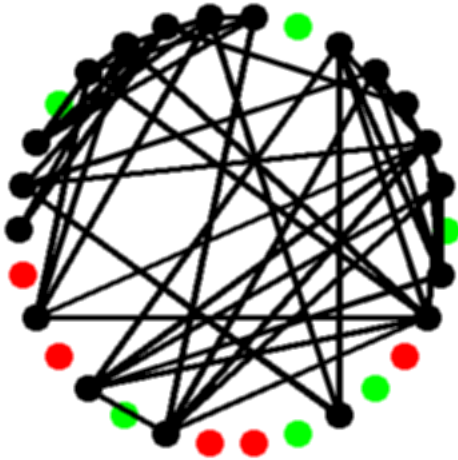
(b) *Do exercise 1.8, part (b). Generate on the computer the conjunctive normal form for the 3-colorability of the two graphs in Fig. 1.8. (Hint: There should be  $N = 12$  variables, three for each node.)*

The DP (Davis–Putnam) algorithm for determining satisfiability is recursive. Tentatively set a variable to true, reduce the clauses involving the variable, and apply DP to the remainder. If the remainder is satisfiable, return satisfiable. Otherwise set the variable to false, again reduce the clauses involving the variable, and return DP applied to the remainder.

To implementing DP, you will want to introduce (i) a data structure that connects a variable to the clauses that contain it, and to the clauses



that contain its negation, and (ii) a record of which clauses are already known to be true (because one of its literals has been tentatively set true). You will want a *reduction routine* which tentatively sets one variable, and returns the variables and clauses changed. (If we reach a dead end—a contradiction forcing us to unset the variable—we'll need these changes in order to back up.) The *recursive solver* which calls the reduction routine should return not only whether the network is satisfiable, and the solution if it exists, but also the number of dead ends that it reached.



**Fig. 8.20 D–P algorithm.** A visualization of the Davis–Putnam algorithm during execution. Black circles are unset variables, the other shades are true and false, and bonds denote clauses whose truth is not established.

(c) Implement the DP algorithm. Apply it to your 3-colorability expressions from part (b).

Let us now explore how computationally challenging a typical, random **3SAT** problem is, as the number  $M/N$  of clauses per variable grows.

(d) Write a routine, given  $k$ ,  $N$  and  $M$ , that generates  $M$  random **kSAT** clauses using  $N$  variables. Make sure that no variable shows up twice in the same clause (positive or negative). For  $N = 5, 10$ , and  $20$  measure the fraction of **2SAT** and **3SAT** problems that are satisfiable, as a function of  $M/N$ . Does the fraction of unsatisfiable clusters change with  $M/N$ ? Around where

is the transition from mostly satisfiable to mostly unsatisfiable? Make plots of the time (measured as number of dead ends) you found for each run, versus  $M/N$ , plotting both mean and standard deviation, and a scatter plot of the individual times. Is the algorithm slowest near the transition?

The DP algorithm can be sped up significantly with a few refinements. The most important is to remove singletons (‘length one’ clauses with all but one variable set to unfavorable values, hence determining the value of the remaining variable). (e) When reducing the clauses involving a tentatively set variable, notice at each stage whether any singletons remain; if so, set them and reduce again. Try your improved algorithm on larger problems. Is it faster?

*Heavy tails and random restarts.* The DP algorithm will eventually return either a solution or a judgment of unsatisfiability, but the time it takes to return an answer fluctuates wildly from one run to another. You probably noticed this in your scatter plots of the times—a few were huge, and the others small. You might think that this is mainly because of the rare, difficult cases. Not so. The time fluctuates wildly even with repeated DP runs on the same satisfiability problem [49].

(f) Run the DP algorithm on a **2SAT** problem many times on a single network with  $N = 40$  variables and  $M = 40$  clauses, randomly shuffling the order in which you select variables to flip. Estimate the power law  $\rho(t) \sim t^x$  giving the probability of the algorithm finishing after time  $t$ . Sort your variables so that the next one chosen (to be tentatively set) is the one most commonly arising (positive or negative) in the clauses. Does that speed up the algorithm? Try also reversing the order, choosing always the least used variable. Does that dramatically slow down your algorithm?

Given that shuffling the order of which spins you start with can make such a dramatic difference in the run time, why persist if you are having trouble? The discovery of the heavy tails motivates adding appropriate *random restarts* to the algorithm [49]; by throwing away the effort spent exploring the neighborhood of one spin choice, one can both improve the average behavior and avoid the heavy tails.

It is known that **2SAT** has a continuous phase transition at  $M/N = 1$ , and that **3SAT** has an

abrupt phase transition (albeit with critical fluctuations) near  $M/N = 4.25$ . **3SAT** is thought to have severe critical slowing-down near the phase transition, whatever algorithm used to solve it. Away from the phase transition, however, the fiendishly difficult cases that take exponentially long for DP to solve are exponentially rare; DP typically will converge quickly.

(g) *Using your best algorithm, plot the fraction of **2SAT** problems that are **SAT** for values of  $N = 25, 50, \text{ and } 100$ . Does the phase transition appear to extrapolate to  $M/N = 1$ , as the literature suggests? For **3SAT**, try  $N = 10, 20, \text{ and } 30$ , and larger systems if your computer is fast. Is your phase transition near  $M/N \approx 4.25$ ? Sit-*

*ting at the phase transition, plot the mean time (dead ends) versus  $N$  in this range. Does it appear that **2SAT** is in **P**? Does **3SAT** seem to take a time which grows exponentially?*

*Other algorithms.* In the past decade, the methods for finding satisfaction have improved dramatically. **WalkSAT** [116] starts not by trying to set one variable at a time, but starts with a random initial state, and does a zero-temperature Monte Carlo, flipping only those variables which are in unsatisfied clauses. The best known algorithm, **SP**, was developed by physicists [48, 92] using techniques developed to study the statistical mechanics of spin-glasses.

# Order parameters, broken symmetry, and topology

## 9

In elementary school, we were taught that there were three states of matter: solid, liquid, and gas. The ancients thought that there were four: earth, water, air, and fire, which was considered sheer superstition. In junior high, the author remembers reading a book as a kid called *The Seven States of Matter* [51]. At least one was ‘plasma’, which made up stars and thus most of the Universe,<sup>1</sup> and which sounded rather like fire.

The original three, by now, have become multitudes. In important and precise ways, magnets are a distinct form of matter. Metals are different from insulators. Superconductors and superfluids are striking new states of matter. The liquid crystal in your wristwatch is one of a huge family of different liquid crystalline states of matter [33] (nematic, cholesteric, blue phase I, II, and blue fog, smectic A, B, C, C\*, D, I, ...). There are over 200 qualitatively different types of crystals, not to mention the quasicrystals (Fig. 9.1). There are disordered states of matter like spin glasses, and states like the fractional quantum Hall effect with excitations of charge  $e/3$  like quarks. Particle physicists tell us that the vacuum we live within has in the past been in quite different states; in the last vacuum before this one, there were four different kinds of light [31] (mediated by what is now the photon, the  $W^+$ , the  $W^-$ , and the Z particle).

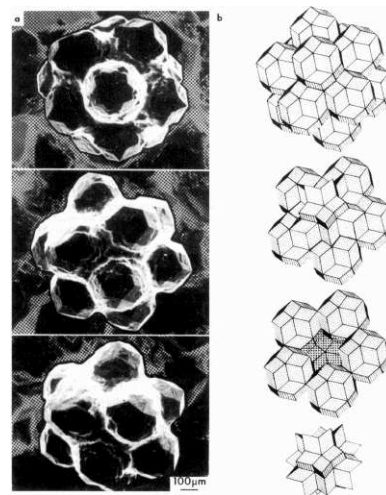
When there were only three states of matter, we could learn about each one and then turn back to learning long division. Now that there are multitudes, though, we have had to develop a system. Our system is constantly being extended and modified, because we keep finding new phases which do not fit into the old frameworks. It is amazing how the 500th new state of matter somehow screws up a system which worked fine for the first 499. Quasicrystals, the fractional quantum hall effect, and spin glasses all really stretched our minds until (1) we understood why they behaved the way they did, and (2) we understood how they fit into the general framework.

In this chapter, we are going to tell you the system. It consists of four basic steps [91]. First, you must identify the broken symmetry (Section 9.1). Second, you must define an order parameter (Section 9.2). Third, you are told to examine the elementary excitations (Section 9.3). Fourth, you classify the topological defects (Section 9.4). Most of what we say in this chapter is taken from Mermin [91], Coleman [31], and deGennes and Prost [33], which are heartily recommended.

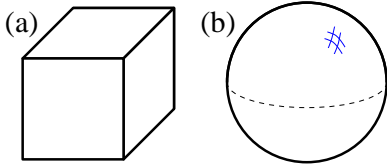
9.1 Identify the broken symmetry	192
9.2 Define the order parameter	192
9.3 Examine the elementary excitations	196
9.4 Classify the topological defects	198

This chapter is slightly modified from a lecture given at the Santa Fe Institute [118].

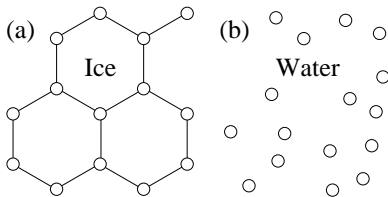
<sup>1</sup>They had not heard of dark matter.



**Fig. 9.1 Quasicrystals.** Crystals are surely the oldest known of the broken-symmetry phases of matter. In the past few decades, we have uncovered an entirely new class of *quasicrystals*, here [72] with icosahedral symmetry. Note the five-fold structures, forbidden in our old categories.



**Fig. 9.2 Which is more symmetric? Cube and sphere.** (a) The cube has many symmetries. It can be rotated by  $90^\circ$ ,  $180^\circ$ , or  $270^\circ$  about any of the three axes passing through the faces. It can be rotated by  $120^\circ$  or  $240^\circ$  about the corners and by  $180^\circ$  about an axis passing from the center through any of the 12 edges. (b) The sphere, though, can be rotated by *any* angle. The sphere respects rotational invariance: all directions are equal. The cube is an object which breaks rotational symmetry: once the cube is there, some directions are more equal than others.



**Fig. 9.3 Which is more symmetric? Ice and water.** At first glance, water seems to have much less symmetry than ice. (a) The picture of ‘two-dimensional’ ice clearly breaks the rotational invariance; it can be rotated only by  $120^\circ$  or  $240^\circ$ . It also breaks the translational invariance; the crystal can only be shifted by certain special distances (whole number of lattice units). (b) The picture of water has no symmetry at all; the atoms are jumbled together with no long-range pattern at all. However, water as a phase has a complete rotational and translational symmetry; the pictures will look the same if the container is tipped or shoved.

<sup>2</sup>This is not to say that different phases always differ by symmetries! Liquids and gases have the same symmetry, and some fluctuating phases in low dimensions do not break a symmetry. It is safe to say, though, that if the two materials have different symmetries, they are different phases.

<sup>3</sup>The particle physicists use order parameter fields too; their quantum fields also hide lots of details about what their quarks and gluons are composed of. The main difference is that they do not know what their fields are composed of. It ought to be reassuring to them that we do not always find our greater knowledge very helpful.

## 9.1 Identify the broken symmetry

What is it that distinguishes the hundreds of different states of matter? Why do we say that water and olive oil are in the same state (the liquid phase), while we say aluminum and (magnetized) iron are in different states? Through long experience, we have discovered that most phases differ in their symmetry.<sup>2</sup>

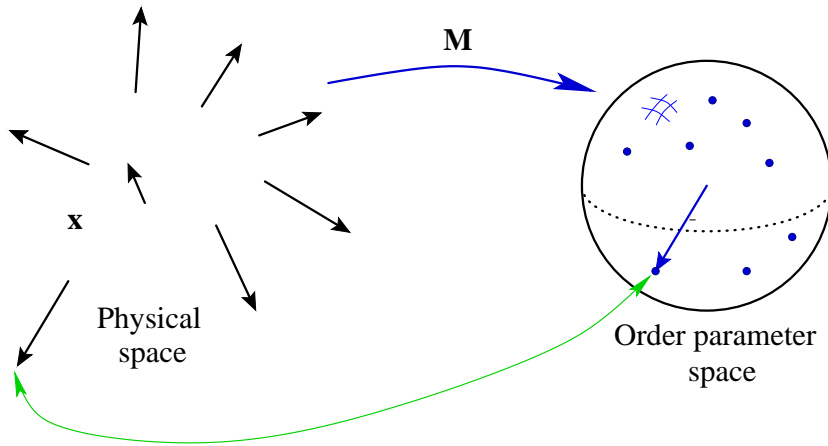
Consider Figs 9.2, showing a cube and a sphere. Which is more symmetric? Clearly, the sphere has many more symmetries than the cube. One can rotate the cube by  $90^\circ$  in various directions and not change its appearance, but one can rotate the sphere by any angle and keep it unchanged.

In Fig. 9.3, we see a two-dimensional schematic representation of ice and water. Which state is more symmetric here? Naively, the ice looks much more symmetric; regular arrangements of atoms forming a lattice structure. Ice has a discrete rotational symmetry: one can rotate Fig. 9.3(a) by multiples of  $60^\circ$ . It also has a discrete translational symmetry: it is easy to tell if the picture is shifted sideways, unless one shifts by a whole number of lattice units. The water looks irregular and disorganized. On the other hand, if one rotated Fig. 9.3(b) by an arbitrary angle, it would still look like water! Water is not a snapshot; it is better to think of it as a combination (or ensemble) of all possible snapshots. While the snapshot of the water shown in the figure has no symmetries, water as a phase has complete rotational and translational symmetry.

## 9.2 Define the order parameter

Particle physics and condensed-matter physics have quite different philosophies. Particle physicists are constantly looking for the building blocks. Once pions and protons were discovered to be made of quarks, the focus was on quarks. Now quarks and electrons and photons seem to be made of strings, and strings are hard to study experimentally (so far). Condensed-matter physicists, on the other hand, try to understand why messy combinations of zillions of electrons and nuclei do such interesting simple things. To them, the fundamental question is not discovering the underlying quantum mechanical laws, but in understanding and explaining the new laws that emerge when many particles interact.<sup>3</sup>

As one might guess, we do not always keep track of all the electrons and protons. We are always looking for the important variables, the important degrees of freedom. In a crystal, the important variables are the motions of the atoms away from their lattice positions. In a magnet, the important variable is the local direction of the magnetization (an arrow pointing to the ‘north’ end of the local magnet). The local magnetization comes from complicated interactions between the electrons,



**Fig. 9.4 Magnetic order parameter.** For a magnetic material at a given temperature, the local magnetization  $|\mathbf{M}| = M_0$  will be pretty well fixed, but the energy is often nearly independent of the direction  $\hat{\mathbf{M}} = \mathbf{M}/M_0$  of the magnetization. Often, the magnetization changes directions in different parts of the material. (That is why not all pieces of iron are magnetic!) We take the magnetization as the order parameter for a magnet; you can think of it as an arrow pointing to the north end of each atomic magnet. The current state of the material is described by an order parameter field  $\mathbf{M}(\mathbf{x})$ . It can be viewed either as an arrow at each point in space, or as a function taking points in space  $\mathbf{x}$  into points on the sphere. This sphere  $\mathbb{S}^2$  is the order parameter space for the magnet.

and is partly due to the little magnets attached to each electron and partly due to the way the electrons dance around in the material; these details are for many purposes unimportant.

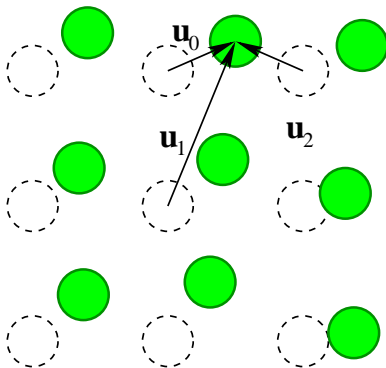
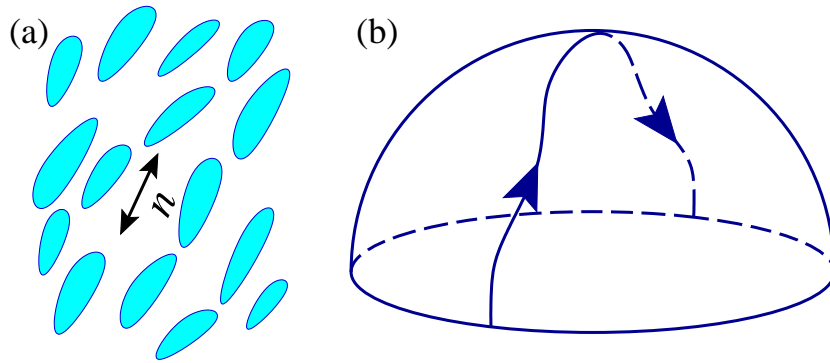
The important variables are combined into an ‘order parameter field’. In Fig. 9.4, we see the order parameter field for a magnet.<sup>4</sup> At each position  $\mathbf{x} = (x, y, z)$  we have a direction for the local magnetization  $\mathbf{M}(\mathbf{x})$ . The length of  $\mathbf{M}$  is pretty much fixed by the material, but the direction of the magnetization is undetermined. By becoming a magnet, this material has broken the rotational symmetry. The order parameter  $\mathbf{M}$  labels which of the various broken symmetry directions the material has chosen.

The order parameter is a field; at each point in our magnet,  $\mathbf{M}(\mathbf{x})$  tells the local direction of the field near  $\mathbf{x}$ . Why would the magnetization point in different directions in different parts of the magnet? Usually, the material has lowest energy when the order parameter field is uniform, when the symmetry is broken in the same way throughout space. In practice, though, the material often does not break symmetry uniformly. Most pieces of iron do not appear magnetic, simply because the local magnetization points in different directions at different places. The magnetization is already there at the atomic level; to make a magnet, you pound the different domains until they line up. We will see in this chapter that much of the interesting behavior we can study involves the way the order parameter varies in space.

The order parameter field  $\mathbf{M}(\mathbf{x})$  can be usefully visualized in two different ways. On the one hand, one can think of a little vector attached to each point in space. On the other hand, we can think of it as a mapping from real space into order parameter space. That is,  $\mathbf{M}$  is a function which takes different points in the magnet onto the surface of a sphere (Fig. 9.4). As we mentioned earlier, mathematicians call the

<sup>4</sup>Most magnets are crystals, which already have broken the rotational symmetry. For some ‘Heisenberg’ magnets, the effects of the crystal on the magnetism is small. Magnets are really distinguished by the fact that they break time-reversal symmetry: if you reverse the arrow of time, the magnetization changes sign.

**Fig. 9.5 Nematic order parameter space.** (a) Nematics are made up of long, thin molecules that prefer to align with one another. (Liquid crystal watches are made of nematics.) Since they do not care much which end is up, their order parameter is not a vector  $\hat{n}$  along the axis of the molecules, but is instead a unit vector up to the equivalence  $\hat{n} \equiv -\hat{n}$ . (b) The nematic order parameter space is a half-sphere, with antipodal points on the equator identified. Thus, for example, the route shown over the top of the hemisphere is a closed path; the two intersections with the equator correspond to the same orientations of the nematic molecules in space.



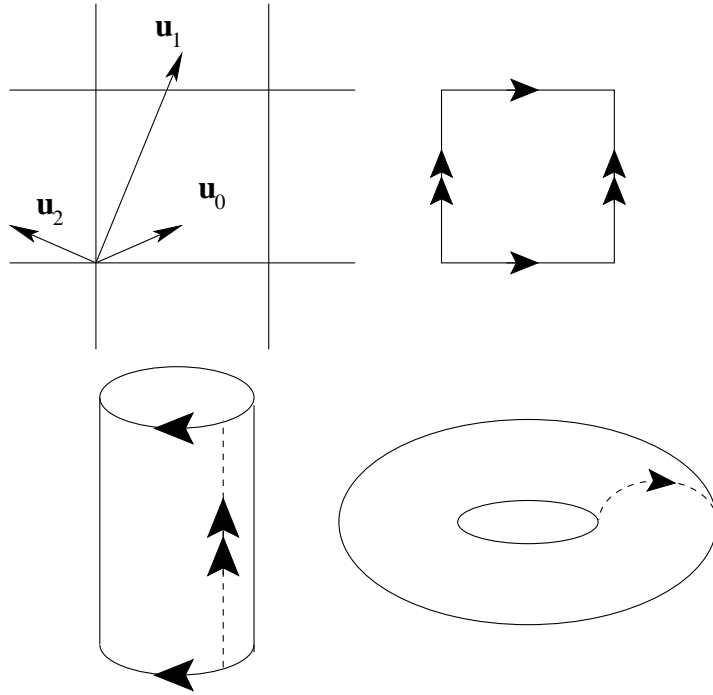
**Fig. 9.6 Two-dimensional crystal.** A crystal consists of atoms arranged in regular, repeating rows and columns. At high temperatures, or when the crystal is deformed or defective, the atoms will be displaced from their lattice positions. The displacement  $\mathbf{u}$  is shown for one of the atoms. Even better, one can think of  $\mathbf{u}(\mathbf{x})$  as the local translation needed to bring the ideal lattice into registry with atoms in the local neighborhood of  $\mathbf{x}$ . Also shown is the ambiguity in the definition of  $u$ . Which ideal atom should we identify with a given real one? This ambiguity makes the order parameter  $u$  equivalent to  $u + m\hat{x} + n\hat{y}$ . Instead of a vector in two dimensions, the order parameter space is a square with periodic boundary conditions.

sphere  $\mathbb{S}^2$ , because locally it has two dimensions. (They do not care what dimension the sphere is embedded in.)

Choosing an order parameter is an art. Usually we are studying a new system which we do not understand yet, and guessing the order parameter is a piece of figuring out what is going on. Also, there is often more than one sensible choice. In magnets, for example, one can treat  $\mathbf{M}$  as a fixed-length vector in  $\mathbb{S}^2$ , labeling the different broken symmetry states. This *topological order parameter* is the best choice at low temperatures, where we study the elementary excitations and topological defects. For studying the transition from low to high temperatures, when the magnetization goes to zero, it is better to consider  $\mathbf{M}$  as a ‘soft-spin’ vector of varying length (a vector in  $\mathbb{R}^3$ , Exercise 9.5). Finding the simplest description for your needs is often the key to the problem.

Before varying our order parameter in space, let us develop a few more examples. The liquid crystals in LCD displays (like those in old digital watches) are nematics. Nematics are made of long, thin molecules which tend to line up so that their long axes are parallel. Nematic liquid crystals, like magnets, break the rotational symmetry. Unlike magnets, though, the main interaction is not to line up the north poles, but to line up the axes. (Think of the molecules as American footballs, the same up and down.) Thus the order parameter is not a vector  $\mathbf{M}$  but a headless vector  $\vec{n} \equiv -\vec{n}$ . The order parameter space is a hemisphere, with opposing points along the equator identified (Fig. 9.5(b)). This space is called  $\mathbb{R}P^2$  by the mathematicians (the projective plane), for obscure reasons.

For a crystal, the important degrees of freedom are associated with the broken translational order. Consider a two-dimensional crystal which has lowest energy when in a square lattice, but which is deformed away from that configuration (Fig. 9.6). This deformation is described by an arrow connecting the undeformed ideal lattice points with the actual positions of the atoms. If we are a bit more careful, we say that  $\mathbf{u}(\mathbf{x})$



**Fig. 9.7 Crystal order parameter space.** Here we see that gluing the opposite edges of a square together (giving it periodic boundary conditions) yields a torus. (A torus is a surface of a doughnut, inner tube, or bagel, depending on your background.)

is that displacement needed to align the ideal lattice in the local region onto the real one. By saying it this way,  $\mathbf{u}$  is also defined between the lattice positions; there still is a best displacement which locally lines up the two lattices.

The order parameter  $\mathbf{u}$  is not really a vector; there is a subtlety. In general, which ideal atom you associate with a given real one is ambiguous. As shown in Fig. 9.6, the displacement vector  $\mathbf{u}$  changes by a multiple of the lattice constant  $a$  when we choose a different reference atom:

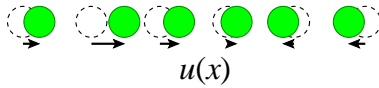
$$\mathbf{u} \equiv \mathbf{u} + a\hat{x} = \mathbf{u} + ma\hat{x} + na\hat{y}. \quad (9.1)$$

The set of distinct order parameters forms a square with periodic boundary conditions. As Fig. 9.7 shows, a square with periodic boundary conditions has the same topology as a torus,  $\mathbb{T}^2$ .

Finally, let us mention that guessing the order parameter (or the broken symmetry) is not always so straightforward. For example, it took many years before anyone figured out that the order parameter for superconductors and superfluid helium 4 is a complex number  $\psi$ .<sup>5</sup> The magnitude of the complex number  $\psi$  is a fixed function of temperature, so the topological order parameter space is the set of complex numbers of magnitude  $|\psi|$ . Thus the order parameter space for superconductors and superfluids is a circle  $\mathbb{S}^1$ .

Now we examine small deformations away from a uniform order parameter field.

<sup>5</sup>The order parameter field  $\psi(\mathbf{x})$  represents the ‘condensate wavefunction’, which (extremely loosely) is a single quantum state occupied by a large fraction of the Cooper pairs or helium atoms in the material. The corresponding broken symmetry is closely related to the number of particles. In ‘symmetric’, normal liquid helium, the local number of atoms is conserved; in superfluid helium, the local number of atoms becomes indeterminate! (This is because many of the atoms are condensed into that delocalized wavefunction; see Exercise 9.8.)



**Fig. 9.8 One-dimensional sound wave.** The order parameter field for a one-dimensional crystal is the local displacement  $u(x)$ . Long-wavelength waves in  $u(x)$  have low frequencies, and cause sound.

Crystals are rigid because of the broken translational symmetry. (Glasses are quite rigid, but we fundamentally do not understand why [130].) Because they are rigid, they fight displacements. Because there is an underlying continuous translational symmetry, a uniform displacement costs no energy. A nearly uniform displacement, thus, will cost little energy, and therefore will have a low frequency. These low-frequency elementary excitations are the sound waves in crystals.

<sup>6</sup>We argue here that low-frequency excitations come from spontaneously broken symmetries. They can also come from conserved quantities; since air cannot be created or destroyed, a long-wavelength density wave cannot relax quickly.

<sup>7</sup>At finite temperatures, we mean a free energy cost.

<sup>8</sup>See Exercises 9.5 and 9.6.

<sup>9</sup>Terms with high derivatives become small when you look on long length and time scales; the  $n$ th derivative  $\partial^n u / \partial x^n \sim 1/D^n$  for a function with variations on a length  $D$ . (Test this; take the 400th derivative of  $u(x) = \cos(2\pi x/D)$ .) Powers of gradients  $(\partial u / \partial x)^n \sim 1/D^n$  are also small.

### 9.3 Examine the elementary excitations

It is amazing how slow human beings are. The atoms inside your eyelash collide with one another a million million times during each time you blink your eye. It is not surprising, then, that we spend most of our time in condensed-matter physics studying those things in materials that happen slowly. Typically only vast conspiracies of immense numbers of atoms can produce the slow behavior that humans can perceive.

A good example is given by sound waves. We will not talk about sound waves in air; air does not have any broken symmetries, so it does not belong in this chapter.<sup>6</sup> Consider instead sound in the one-dimensional crystal shown in Fig. 9.8. We describe the material with an order parameter field  $u(x)$ , where here  $x$  is the position within the material and  $x - u(x)$  is the position of the reference atom within the ideal crystal.

Now, there must be an energy cost<sup>7</sup> for deforming the ideal crystal. There will not be any cost, though, for a uniform translation;  $u(x) \equiv u_0$  has the same energy as the ideal crystal. (Shoving all the atoms to the right does not cost any energy.) So, the energy will depend only on derivatives of the function  $u(x)$ . The simplest energy that one can write looks like<sup>8</sup>

$$\mathcal{E} = \int dx \frac{1}{2} \kappa \left( \frac{du}{dx} \right)^2. \quad (9.2)$$

Higher derivatives will not be important for the low frequencies that humans can hear.<sup>9</sup> Now, you may remember Newton's law  $F = ma$ . The force here is given by the derivative of the energy  $F = -(d\mathcal{E}/d\Gamma)$ . The mass is represented by the density of the material  $\rho$ . Working out the math (a variational derivative and an integration by parts, for those who are interested) gives us the *wave equation*

$$\rho \ddot{u} = \kappa (d^2 u / dx^2). \quad (9.3)$$

The solutions to this equation

$$u(x, t) = u_0 \cos(kx - \omega_k t) \quad (9.4)$$

represent phonons or sound waves. The wavelength of the sound waves is  $\lambda = 2\pi/k$ , and the frequency is  $\omega$  in radians per second. Substituting eqn 9.4 into eqn 9.3 gives us the relation

$$\omega = \sqrt{\kappa/\rho} k. \quad (9.5)$$

The frequency gets small only when the wavelength gets large. This is the vast conspiracy: only huge sloshings of many atoms can happen slowly. *Why does the frequency get small?* Well, there is no cost to a uniform translation, which is what eqn 9.4 looks like for infinite wavelength. *Why is there no energy cost for a uniform displacement?* Well, there is a translational symmetry: moving all the atoms the same amount does not change their interactions. *But have we not broken that symmetry?* That is precisely the point.



Long after phonons were understood, Jeffrey Goldstone started to think about broken symmetries and order parameters in the abstract. He found a rather general argument that, whenever a continuous symmetry (rotations, translations,  $SU(3)$ , ...) is broken, long-wavelength modulations in the symmetry direction should have low frequencies (see Exercise 10.9). The fact that the lowest energy state has a broken symmetry means that the system is stiff; modulating the order parameter will cost an energy rather like that in eqn 9.2. In crystals, the broken translational order introduces a rigidity to shear deformations, and low-frequency phonons (Fig. 9.8). In magnets, the broken rotational symmetry leads to a magnetic stiffness and spin waves (Fig. 9.9). In nematic liquid crystals, the broken rotational symmetry introduces an orientational elastic stiffness (they pour, but resist bending!) and rotational waves (Fig. 9.10).

In superfluids, an exotic broken *gauge symmetry*<sup>10</sup> leads to a stiffness which results in the superfluidity. Superfluidity and superconductivity really are not any more amazing than the rigidity of solids. Is it not amazing that chairs are rigid? Push on a few atoms on one side and,  $10^9$  atoms away, atoms will move in lock-step. In the same way, decreasing the flow in a superfluid must involve a cooperative change in a macroscopic number of atoms, and thus never happens spontaneously any more than two parts of the chair ever drift apart.

The low-frequency Goldstone modes in superfluids are heat waves! (Do not be jealous; liquid helium has rather cold heat waves.) This is often called second sound, but is really a periodic temperature modulation, passing through the material like sound does through a crystal.

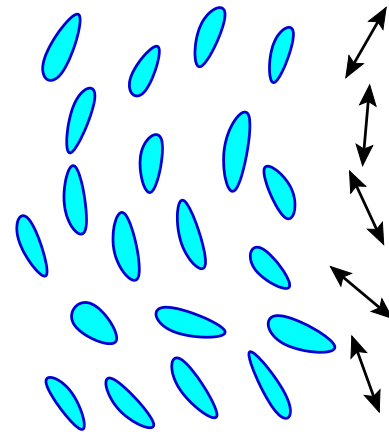
Just to round things out, what about superconductors? They have also got a broken gauge symmetry, and have a stiffness that leads to superconducting currents. What is the low-energy excitation? It does not have one. But what about Goldstone's theorem?

Goldstone of course had conditions on his theorem which excluded superconductors. (Actually, Goldstone was studying superconductors when he came up with his theorem.) It is just that everybody forgot the extra conditions, and just remembered that you always got a low-frequency mode when you broke a continuous symmetry. We condensed-matter physicists already knew why there is no Goldstone mode for superconductors; P. W. Anderson had shown that it was related to the long-range Coulomb interaction, and its absence is related to the Meissner effect. The high-energy physicists forgot, though, and had to rediscover it for themselves. Now we all call the loophole in Goldstone's theorem the Higgs mechanism, because (to be truthful) Higgs and his high-energy friends found a simpler and more elegant explanation than we condensed-matter physicists had.<sup>11</sup>

We end this section by bringing up another exception to Goldstone's theorem; one we have known about even longer, but which we do not have a nice explanation for. What about the orientational order in crystals? Crystals break both the continuous translational order and the continuous orientational order. The phonons are the Goldstone modes



**Fig. 9.9 Magnets: spin waves.** Magnets break the rotational invariance of space. Because they resist twisting the magnetization locally, but do not resist a uniform twist, they have low-energy spin wave excitations.



**Fig. 9.10 Nematic liquid crystals: rotational waves.** Nematic liquid crystals also have low-frequency rotational waves.

<sup>10</sup>See Exercise 9.8.

<sup>11</sup>In condensed-matter language, the Goldstone mode produces a charge-density wave, whose electric fields are independent of wavelength. This gives it a finite frequency (the plasma frequency) even at long wavelength. In high-energy language the photon eats the Goldstone boson, and gains a mass. The Meissner effect is related to the gap in the order parameter fluctuations ( $\hbar$  times the plasma frequency), which the high-energy physicists call the mass of the Higgs boson.

for the translations, but *there are no orientational Goldstone modes in crystals*.<sup>12</sup> Rotational waves analogous to those in liquid crystals (Fig. 9.10) are basically not allowed in crystals; at long distances they tear up the lattice. We understand this microscopically in a clunky way, but do not have an elegant, macroscopic explanation for this basic fact about solids.

## 9.4 Classify the topological defects

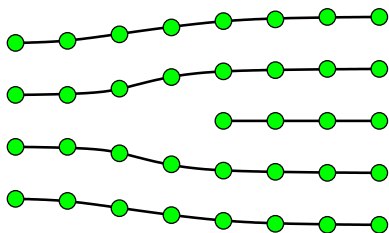
When the author was in graduate school, the big fashion was topological defects. Everybody was studying homotopy groups, and finding exotic systems to write papers about. It was, in the end, a reasonable thing to do.<sup>13</sup> It is true that in a typical application you will be able to figure out what the defects are without homotopy theory. You will spend forever drawing pictures to convince anyone else, though. Most importantly, homotopy theory helps you to think about defects.

A defect is a tear in the order parameter field. A topological defect is a tear that cannot be patched. Consider the piece of two-dimensional crystal shown in Fig. 9.11. Starting in the middle of the region shown, there is an extra row of atoms. (This is called a dislocation.) Away from the middle, the crystal locally looks fine; it is a little distorted, but there is no problem seeing the square grid and defining an order parameter. Can we rearrange the atoms in a small region around the start of the extra row, and patch the defect?

No. The problem is that we can tell there is an extra row without ever coming near to the center. The traditional way of doing this is to traverse a large loop surrounding the defect, and count the net number of rows crossed by the loop. For the loop shown in Fig. 9.12, there are two rows going up and three going down; no matter how far we stay from the center, there will always be an extra row on the right.

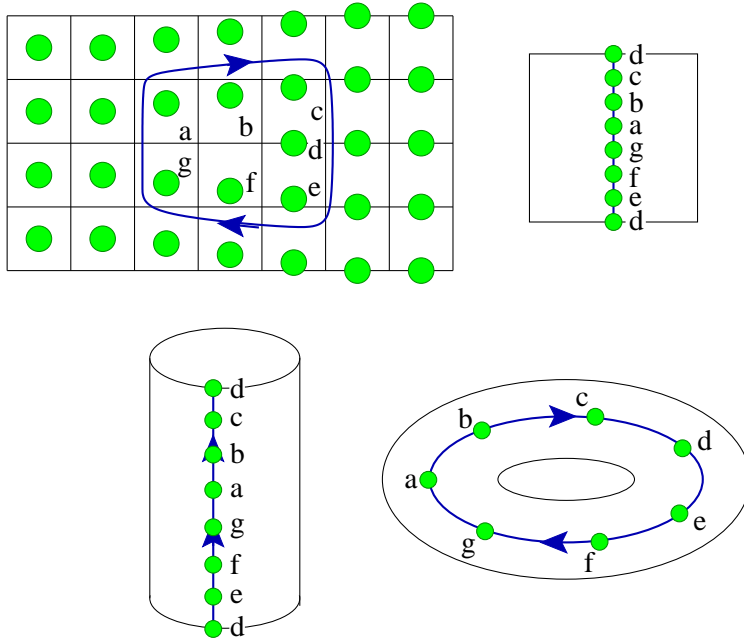
How can we generalize this basic idea to other systems with broken symmetries? Remember that the order parameter space for the two-dimensional square crystal is a torus (see Fig. 9.7), and that the order parameter at a point is that translation which aligns a perfect square grid to the deformed grid at that point. Now, what is the order parameter far to the left of the defect (a), compared to the value far to the right (d)? The lattice to the right is shifted vertically by half a lattice constant; the order parameter has been shifted half-way around the torus. As

<sup>13</sup>The next fashion, catastrophe theory, never became particularly important.



**Fig. 9.11 Dislocation in a crystal.** Here is a topological defect in a crystal. We can see that one of the rows of atoms on the right disappears half-way through our sample. The place where it disappears is a defect, because it does not locally look like a piece of the perfect crystal. It is a topological defect because it cannot be fixed by any local rearrangement. No reshuffling of atoms in the middle of the sample can change the fact that five rows enter from the right, and only four leave from the left! The Burger's vector of a dislocation is the net number of extra rows and columns, combined into a vector (columns, rows).

<sup>12</sup>In two dimensions, crystals provide another loophole in a well-known result, known as the Mermin-Wagner theorem. Hohenberg, Mermin, and Wagner, in a series of papers, proved in the 1960s that two-dimensional systems with a continuous symmetry cannot have a broken symmetry at finite temperature. At least, that is the English phrase everyone quotes when they discuss the theorem; they actually prove it for several particular systems, including superfluids, superconductors, magnets, and translational order in crystals. Indeed, crystals in two dimensions do not break the translational symmetry; at finite temperatures, the atoms wiggle enough so that the atoms do not sit in lock-step over infinite distances (their translational correlations decay slowly with distance). But the crystals do have a broken orientational symmetry: the crystal axes point in the same directions throughout space. (Mermin discusses this point in his paper on crystals.) The residual translational correlations (the local alignment into rows and columns of atoms) introduce long-range forces which force the crystalline axes to align, breaking the continuous rotational symmetry.



**Fig. 9.12 Loop around the dislocation** mapped onto order parameter space. Consider a closed loop around the defect. The order parameter field  $u$  changes as we move around the loop. The positions of the atoms around the loop with respect to their local ‘ideal’ lattice drift upward continuously as we traverse the loop. This precisely corresponds to a path around the hole of the torus. A path *through* the hole corresponds to an extra column of atoms. Moving the atoms slightly will deform the path, but will not change the number of times the path winds through or around the hole. Two paths which traverse the torus the same number of times through and around are equivalent.

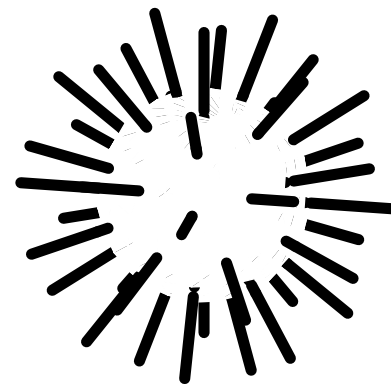
shown in Fig. 9.12, as you progress along the top half of a clockwise loop the order parameter (position of the atom within the unit cell) moves upward, and along the bottom half again moves upward. All in all, the order parameter circles once around the torus. The winding number around the torus is the net number of times the torus is circumnavigated when the defect is orbited once.

Why do we call dislocations topological defects? *Topology* is the study of curves and surfaces where bending and twisting is ignored. An order parameter field, no matter how contorted, which does not wind around the torus can always be smoothly bent and twisted back into a uniform state. If along any loop, though, the order parameter winds either around the hole or through it a net number of times, then enclosed in that loop is a defect which cannot be bent or twisted flat; the winding number (an integer) cannot change in a smooth and continuous fashion.

How do we categorize the defects for two-dimensional square crystals? Well, there are two integers: the number of times we go around the central hole, and the number of times we pass through it. In the traditional description, this corresponds precisely to the number of extra rows and columns of atoms we pass by. This was named the Burger’s vector in the old days, and nobody needed to learn about tori to understand it. We now call it the first homotopy group of the torus:

$$\Pi_1(\mathbb{T}^2) = \mathbb{Z} \times \mathbb{Z}, \tag{9.6}$$

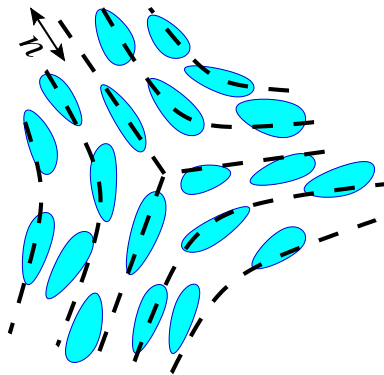
where  $\mathbb{Z}$  represents the integers. That is, a defect is labeled by two



**Fig. 9.13 Hedgehog defect.** Magnets have no line defects (you cannot lasso a basketball), but do have point defects. Here is shown the hedgehog defect,  $\mathbf{M}(\mathbf{x}) = M_0 \hat{x}$ . You cannot surround a point defect in three dimensions with a loop, but you can enclose it in a sphere. The order parameter space, remember, is also a sphere. The order parameter field takes the enclosing sphere and maps it onto the order parameter space, wrapping it exactly once. The point defects in magnets are categorized by this *wrapping number*; the second homotopy group of the sphere is  $\mathbb{Z}$ , the integers.

<sup>14</sup>Some paper clips also work harden, but less dramatically (partly because they have already been bent). After several bendings, they will stop hardening and start to weaken dramatically; that is because they are beginning to break in two.

<sup>15</sup>This again is the mysterious lack of rotational Goldstone modes in crystals, (note 12 on p. 198), which would otherwise mediate the bend. See also Exercise 11.5.



**Fig. 9.14 Defect line in a nematic liquid crystal.** You cannot lasso the sphere, but you can lasso a hemisphere! Here is the defect corresponding to the path shown in Fig. 9.5(b). As you pass clockwise around the defect line, the order parameter rotates counter-clockwise by 180°. This path on Fig. 9.5(b) would actually have wrapped around the right-hand side of the hemisphere. Wrapping around the left-hand side would have produced a defect which rotated clockwise by 180°. The path in Fig. 9.5(b) is half-way in between, and illustrates that these two defects are really not different topologically (Exercise 9.1).

<sup>16</sup>The zeroth homotopy group classifies domain walls. The third homotopy group, applied to defects in three-dimensional materials, classifies what the condensed-matter people call *textures* and the particle people sometimes call *skyrmions*. The fourth homotopy group, applied to defects in space-time path integrals, classifies types of *instantons*.

integers  $(m, n)$ , where  $m$  represents the number of extra rows of atoms on the right-hand part of the loop, and  $n$  represents the number of extra columns of atoms on the bottom.

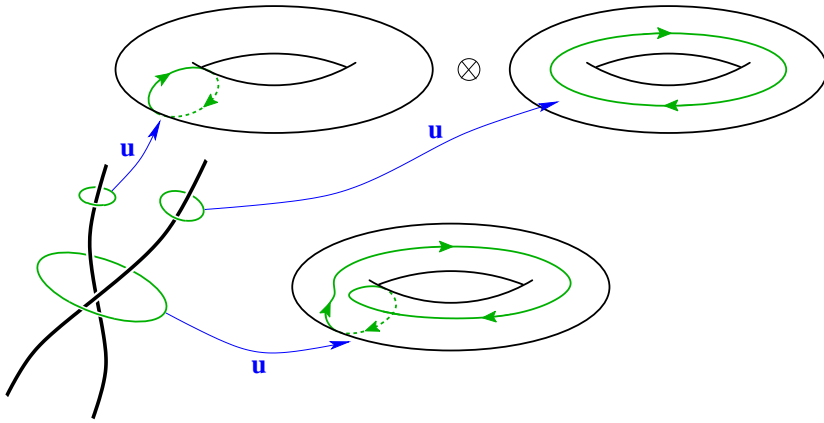
This is where we show the practical importance of topological defects. Unfortunately for you, we cannot enclose a soft copper tube for you to play with, the way the author does in lectures.<sup>14</sup> They are a few cents each, and machinists on two continents have been quite happy to cut them up for demonstrations, but they do not pack well into books. Anyhow, copper and most metals exhibit what is called *work hardening*. It is easy to bend the tube, but it is amazingly tough to bend it back. The soft original copper is relatively defect free. To bend, the crystal has to create lots of line dislocations, which move around to produce the bending<sup>15</sup> The line defects get tangled up, and get in the way of any new defects. So, when you try to bend the tube back, the metal becomes much stiffer. Work hardening has had a noticeable impact on the popular culture. The magician effortlessly bends the metal bar, and the strongman cannot straighten it ... Superman bends the rod into a pair of handcuffs for the criminals ...

Before we explain why these paths form a group, let us give some more examples of topological defects and how they can be classified. Figure 9.13 shows a ‘hedgehog’ defect for a magnet. The magnetization simply points straight out from the center in all directions. How can we tell that there is a defect, always staying far away? Since this is a point defect in three dimensions, we have to surround it with a sphere. As we move around on this sphere in ordinary space, the order parameter moves around the order parameter space (which also happens to be a sphere, of radius  $|\mathbf{M}|$ ). In fact, the order parameter space is covered exactly once as we surround the defect. This is called the *wrapping number*, and does not change as we wiggle the magnetization in smooth ways. The point defects of magnets are classified by the wrapping number:

$$\Pi_2(\mathbb{S}^2) = \mathbb{Z}. \tag{9.7}$$

Here, the 2 subscript says that we are studying the second homotopy group. It represents the fact that we are surrounding the defect with a two-dimensional spherical surface, rather than the one-dimensional curve we used in the crystal.<sup>16</sup>

You might get the impression that a defect with topological strength seven is really just seven strength 1 defects, stuffed together. You would be quite right; occasionally defects do bunch up, but usually big ones decompose into small ones. This does not mean, though, that adding two defects always gives a bigger one. In nematic liquid crystals, two line defects are as good as none! Magnets do not have any line defects; a loop in real space never surrounds something it cannot smooth out. Formally, we show this by noting that the first homotopy group of the sphere is zero; any closed path on a basketball can be contracted to a point. For a nematic liquid crystal, though, the order parameter space was a hemisphere. There is a path on the hemisphere in Fig. 9.5(b) that you cannot get rid of by twisting and stretching. It does not look



**Fig. 9.15 Multiplying two paths.**

The product of two paths is given by starting from their intersection, traversing the first path, and then traversing the second. The inverse of a path is the same path traveled backward; compose the two and one can shrink them continuously back to nothing. This definition makes the homotopy classes into a group.

This multiplication law has a physical interpretation. If two defect lines coalesce, their homotopy class must be given by the loop enclosing both. This large loop can be deformed into two little loops, so the homotopy class of the coalesced line defect is the product of the homotopy classes of the individual defects.

like a closed path, but you have to remember that the two opposing points on the equator really represent the same nematic orientation. The corresponding defect has a director field  $n$  which rotates  $180^\circ$  as the defect is orbited; Fig. 9.14 shows one typical configuration (called an  $s = -1/2$  defect). Now, if you put two of these defects together, they cancel (Exercise 9.1). Nematic line defects add modulo 2, like ‘clock arithmetic’ with two hours in a day:<sup>17</sup>

$$\Pi_1(\mathbb{R}P^2) = \mathbb{Z}_2. \tag{9.8}$$

Two parallel defects can coalesce and heal, even though each one individually is stable; each goes half-way around the sphere, and the whole path can be shrunk to zero.

Finally, why are these defect categories a group? A group is a set with a multiplication law, not necessarily commutative, and an inverse for each element. For the first homotopy group, the elements of the group are equivalence classes of paths; two paths are equivalent if one can be stretched and twisted onto the other, staying in the order parameter space at all times.<sup>18</sup> For example, any path going through the hole from the top (as in the top right-hand torus in Fig. 9.15) is equivalent to any other one. To multiply a path  $u$  and a path  $v$ , one must first make sure that they meet at some point (by dragging them together, probably). Then one defines a new path  $u \otimes v$  by traversing first the path  $u$  and then  $v$ .<sup>19</sup>

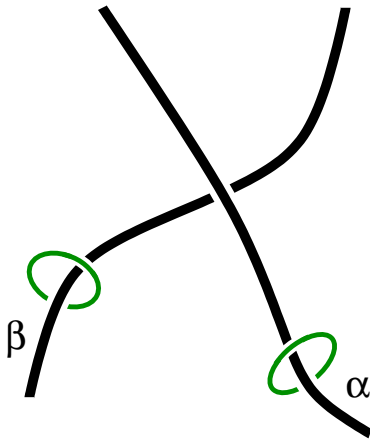
The inverse of a path  $u$  is just the path which runs along the same path in the reverse direction. The identity element consists of the equivalence class of paths which do not enclose a hole; they can all be contracted smoothly to a point (and thus to one another). Finally, the multiplication law has a direct physical implication: encircling two defect lines of strength  $u$  and  $v$  is completely equivalent to encircling one defect of strength  $u \otimes v$  (Fig. 9.15).

This all seems pretty abstract; maybe thinking about order parameter

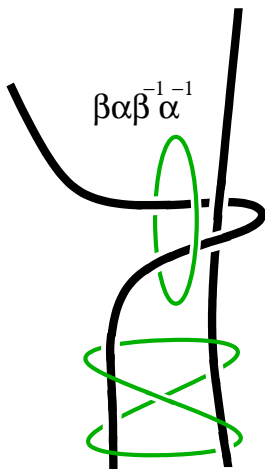
<sup>17</sup>In this analogy, we ignore the re-use of hour names in the afternoon.

<sup>18</sup>A path is a continuous mapping from the circle into the order parameter space:  $\theta \rightarrow u(\theta)$ ,  $0 \leq \theta < 2\pi$ . When we encircle the defect with a loop, we get a path in order parameter space as shown in Fig. 9.4;  $\theta \rightarrow \mathbf{x}(\theta)$  is the loop in real space, and  $\theta \rightarrow \mathbf{u}(\mathbf{x}(\theta))$  is the path in order parameter space. Two paths are equivalent if there is a continuous one-parameter family of paths connecting one to the other:  $u \equiv v$  if there exists  $u_t(\theta)$  continuous both in  $\theta$  and in  $0 \leq t \leq 1$ , with  $u_0 \equiv u$  and  $u_1 \equiv v$ .

<sup>19</sup>That is, if  $u$  and  $v$  meet at  $\theta = 0 \equiv 2\pi$ , we define  $u \otimes v(\theta) \equiv u(2\theta)$  for  $0 \leq \theta \leq \pi$ , and  $u \otimes v(\theta) \equiv v(2\theta)$  for  $\pi \leq \theta \leq 2\pi$ .



**Fig. 9.16 Two defects: can they cross?** Can a defect line of class  $\alpha$  pass by a line of class  $\beta$ , without getting topologically entangled?



**Fig. 9.17 Pulling off a loop around two defects.** We see that we can pass by if we leave a trail; is the connecting double line topologically equal to the identity (no defect)? Encircle the double line by a loop. The loop can be wiggled and twisted off the double line, but it still circles around the two legs of the defects  $\alpha$  and  $\beta$ .

spaces and paths helps one think more clearly, but are there any real uses for talking about the group structure? Let us conclude this chapter with an amazing, physically interesting consequence of the multiplication laws we described.

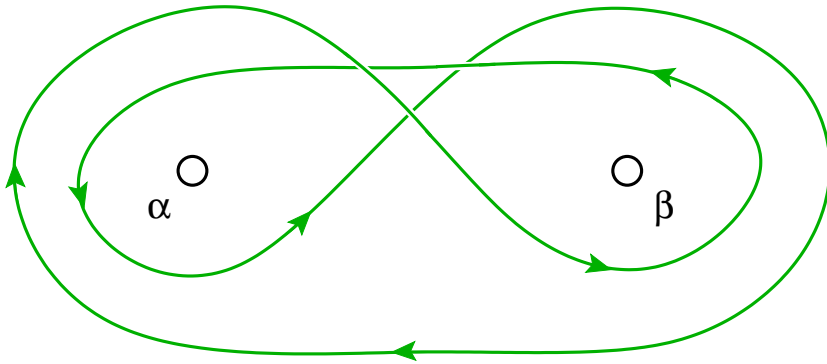
Can two defect lines cross one another? Figure 9.16 shows two defect lines, of strength (homotopy type)  $\alpha$  and  $\beta$ , which are not parallel. Suppose there is an external force pulling the  $\alpha$  defect past the  $\beta$  one. Figure 9.17 shows the two line defects as we bend and stretch one to pass by the other. There is a trail left behind of two parallel defect lines.  $\alpha$  can really leave  $\beta$  behind only if it is topologically possible to erase the trail. Can the two lines annihilate one another? Only if their net strength is zero, as measured by the loop in 9.17.

Now, get two wires and some string. Bend the wires into the shape found in Fig. 9.17. Tie the string into a fairly large loop, surrounding the doubled portion. Wiggle the string around, and try to get the string out from around the doubled section. You will find that you cannot completely remove the string (It is against the rules to pull the string past the cut ends of the defect lines!), but that you can slide it downward into the configuration shown in Fig. 9.18.

Now, in this figure we see that each wire is encircled once clockwise and once counter-clockwise. Do they cancel? Not necessarily! If you look carefully, the order of traversal is such that the net homotopy class is  $\beta\alpha\beta^{-1}\alpha^{-1}$ , which is only the identity if  $\beta$  and  $\alpha$  commute. Thus the physical entanglement problem for defects is directly connected to the group structure of the paths; commutative defects can pass through one another, non-commutative defects entangle.

It would be tidy if we could tell you that the work hardening in copper is due to topological entanglements of defects. It would not be true. The homotopy group of dislocation lines in fcc copper is commutative. (It is rather like the two-dimensional square lattice; if  $\alpha = (m, n)$  and  $\beta = (o, p)$  with  $m, n, o, p$  the number of extra horizontal and vertical lines of atoms, then  $\alpha\beta = (m + o, n + p) = \beta\alpha$ .) The reason dislocation lines in copper do not pass through one another is energetic, not topological. The two dislocation lines interact strongly with one another, and energetically get stuck when they try to cross. Remember at the beginning of the chapter, we said that there were gaps in the system; the topological theory can only say when things are impossible to do, not when they are difficult to do.

It would be nice to tell you that this beautiful connection between the commutativity of the group and the entanglement of defect lines is nonetheless important in lots of other contexts. That too would not be true. There are two types of materials known which are supposed to suffer from defect lines which topologically entangle. The first are biaxial nematics, which were thoroughly analyzed theoretically before anyone found one. The other are the metallic glasses, where David Nelson has a theory of defect lines needed to relieve the frustration. Nelson's defects do not commute, and so cannot cross one another. He originally hoped to explain the freezing of the metallic glasses into random configurations



**Fig. 9.18 Non-commuting defects.** The homotopy class for the loop is precisely  $\beta\alpha\beta^{-1}\alpha^{-1}$ , which is the identity (no defect) precisely when  $\beta\alpha = \alpha\beta$ . Thus two defect lines can pass by one another if their homotopy classes commute!

as an entanglement of defect lines. Nobody has ever been able to take this idea and turn it into a real calculation, though.

## Exercises

Topological defects are entertaining and challenging to visualize and understand. *Topological defects in nematic liquid crystals* provides a physical visualization of homotopy theory and an integral form for the topological charge. *Topological defects in the XY model* explores the defect composition law. The energetics and internal structure of a point defect is studied in *Defect energetics and total divergence terms*, and a surface defect in *Domain walls in magnets*.

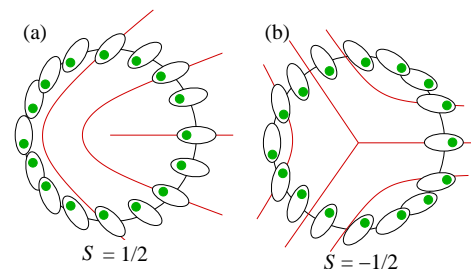
The use of symmetry to develop new laws of matter without microscopic input is explored in *Symmetries and wave equations* and *Landau theory for the Ising model*. The latter develops the most general free energy density allowed by symmetry, while the former uses symmetry to find the equations of motion directly.

Where do the order parameters come from? In simple liquid crystals and magnets, one has an intuitive feel for the broken symmetry state. In *Superfluid order and vortices* and the challenging exercise *Superfluids: density matrices and ODLRO* we derive in increasing levels of rigor the complex order parameter and broken gauge symmetry characteristic of superfluidity.

(9.1) **Topological defects in nematic liquid crystals.** (Mathematics, Condensed matter) ③

The winding number  $S$  of a defect is  $\theta_{\text{net}}/2\pi$ , where  $\theta_{\text{net}}$  is the net angle of rotation that the order parameter makes as you circle the defect. The

winding number is positive if the order parameter rotates in the same direction as the traversal (Fig. 9.19(a)), and negative if it rotates in the opposite directions (Fig. 9.19(b)).

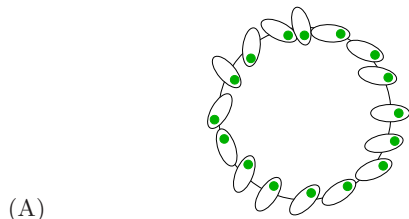


**Fig. 9.19 Defects in nematic liquid crystals.** (a)  $S = \frac{1}{2}$  disclination line. (b)  $S = -\frac{1}{2}$  disclination. The dots are not physical, but are a guide to help you trace the orientations (starting on the left and moving clockwise); nematic liquid molecules often have a head and tail, but there is no long-range correlation in which direction the heads lie.

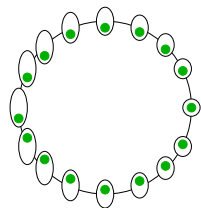
As you can deduce topologically (Fig. 9.5(b) on p. 194), the winding number is *not* a topological invariant in general. It is for superfluids  $\mathbb{S}^1$  and crystals  $\mathbb{T}^D$ , but not for Heisenberg magnets or nematic liquid crystals (shown). If we treat the

plane of the figure as the equator of the hemisphere, you can see that the  $S = 1/2$  defect rotates around the sphere around the left half of the equator, and the  $S = -1/2$  defect rotates around the right half of the equator. These two paths can be smoothly deformed into one another; the path shown on the order parameter space figure (Fig. 9.5(b)) is about half-way between the two.

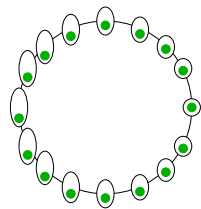
Which figure below represents the defect configuration in real space half-way between  $S = 1/2$  and  $S = -1/2$ , corresponding to the intermediate path shown in Fig. 9.5(b) on p. 194? (The changing shapes denote rotations into the third dimension.)



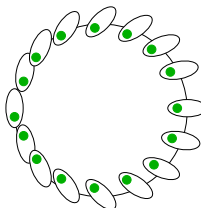
(A)



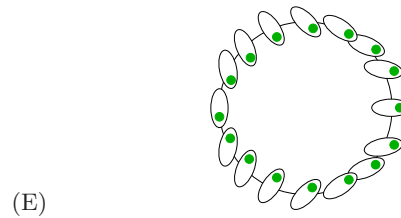
(B)



(C)



(D)

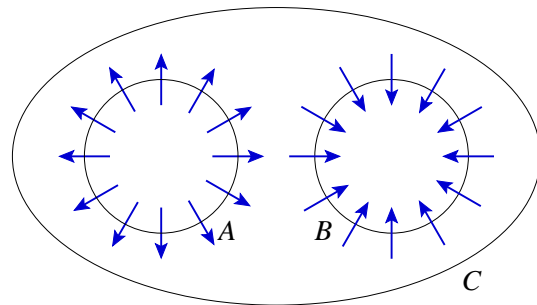


(E)

(9.2) Topological defects in the XY model.

(Mathematics, Condensed matter) ③

Let the order parameter field  $\mathbf{m}(x, y)$  of a two-dimensional XY model be a unit vector field in the plane (order parameter space  $S^1$ ). The topological defects are characterized by their winding number  $s$ , since  $\Pi_1(S^1) = \mathbb{Z}$ . The winding number is the number of counter-clockwise orbits around the order parameter space for a single counter-clockwise path around the defect.



**Fig. 9.20 XY defect pair.** Two topological defects, circumscribed by loops  $A$  and  $B$  running counter-clockwise; the pair of defects is circumscribed by a path  $C$  also going counter-clockwise. The path in order parameter space mapped to from  $C$ , as a homotopy group element, is the group product of the paths from  $A$  and  $B$ .

(a) What are the winding numbers of the two defects surrounded by paths  $A$  and  $B$  in Fig. 9.20? What should the winding number be around path  $C$ , according to the group multiplication law for  $\Pi_1(S^1)$ ?

(b) Copy the figure onto a separate sheet of paper, and fill in the region around  $A$  and  $B$  past  $C$  with a smooth, non-singular, non-vanishing order parameter field of unit vectors. (Hint: You can use your answer for (b) to check your answer for (a).)

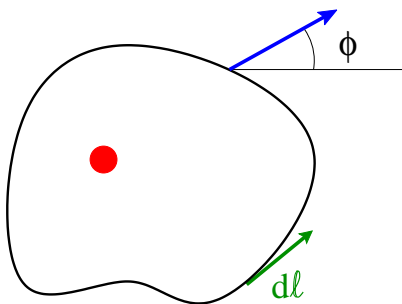


We can find a formula for the winding number as an integral around the defect in the two-dimensional XY model. Let  $D$  encircle a defect counter-clockwise once (Fig. 9.21).

(c) Show that the winding number is given by the line integral around the curve  $D$ :

$$s = \frac{1}{2\pi} \oint \sum_{j=1}^2 (m_1 \partial_j m_2 - m_2 \partial_j m_1) dl_j, \quad (9.9)$$

where the two coordinates are  $x_1$  and  $x_2$ ,  $\partial_j = \partial/\partial x_j$ , and  $l_j$  is the tangent vector to the contour being integrated around (so the integral is of the form  $\oint \mathbf{v} \cdot d\mathbf{l}$ ). (Hints: Write  $\mathbf{m} = (\cos(\phi), \sin(\phi))$ ; the integral of a directional derivative  $\nabla f \cdot d\mathbf{l}$  is the difference in  $f$  between the two endpoints.)



**Fig. 9.21 Looping the defect.** The curve  $D$  encircles the defect once;  $d\mathbf{l}$  is a unit vector tangent to  $D$  running counter-clockwise. Define  $\phi$  to be the angle between the unit vector  $\mathbf{m}$  and the  $x$ -axis.

There are other useful formulæ of this kind. For example, the wrapping number of a vector order parameter around the sphere  $\Pi_2(\mathbb{S}^2)$  is given by an integral of the Jacobian of the order parameter field.<sup>20</sup>

(9.3) **Defect energetics and total divergence terms.** (Condensed matter, Mathematics) ③

A hypothetical liquid crystal is described by a unit-vector order parameter  $\hat{\mathbf{n}}$ , representing the orientation of the long axis of the molecules. (Think of it as a nematic liquid crystal where the heads of the molecules all line up as well.<sup>21</sup>) The

free energy density is normally written

$$\mathcal{F}_{\text{bulk}}[\hat{\mathbf{n}}] = \frac{K_{11}}{2} (\text{div } \hat{\mathbf{n}})^2 + \frac{K_{22}}{2} (\hat{\mathbf{n}} \cdot \text{curl } \hat{\mathbf{n}})^2 + \frac{K_{33}}{2} (\hat{\mathbf{n}} \times \text{curl } \hat{\mathbf{n}})^2. \quad (9.10)$$

Assume a spherical droplet of radius  $R_0$  contains a hedgehog defect (Fig. 9.13, p. 199) in its center, with order parameter field  $\hat{\mathbf{n}}(\mathbf{r}) = \hat{\mathbf{r}} = \mathbf{r}/|\mathbf{r}| = (x, y, z)/\sqrt{x^2 + y^2 + z^2}$ . The hedgehog is a topological defect, which wraps around the sphere once.

(a) Show that  $\text{curl } \hat{\mathbf{n}} = 0$  for the hedgehog. Calculate the free energy of the hedgehog, by integrating  $\mathcal{F}[\hat{\mathbf{n}}]$  over the sphere. Compare the free energy to the energy in the same volume with  $\hat{\mathbf{n}}$  constant (say, in the  $\hat{x}$  direction).

There are other terms allowed by symmetry that are usually not considered as part of the free energy density, because they are total divergence terms. Any term in the free energy which is a divergence of a vector field, by Gauss's theorem, is equivalent to the flux of the vector field out of the boundary of the material. For periodic boundary conditions such terms vanish, but our system has a boundary. For large systems these terms scale like the surface area, where the other terms in the free energy can grow proportional to the volume—but they do not always do so.

(b) Consider the effects of an additional term  $\mathcal{F}_{\text{div}}[\hat{\mathbf{n}}] = K_0 (\text{div } \hat{\mathbf{n}})$ , allowed by symmetry, in the free energy  $\mathcal{F}[\hat{\mathbf{n}}]$ . Calculate its contribution to the energy of the hedgehog, both by integrating it over the volume of the sphere and by using Gauss's theorem to calculate it as a surface integral. Compare the total energy  $\int \mathcal{F}_{\text{bulk}} + \mathcal{F}_{\text{div}} d^3r$  with that of the uniform state with  $\hat{\mathbf{n}} = \hat{x}$ , and with the anti-hedgehog,  $\hat{\mathbf{n}}(\mathbf{r}) = -\hat{\mathbf{r}}$ . Which is lowest, for large  $R_0$ ? How does the ground state for large  $R_0$  depend on the sign of  $K_0$ ?

The term  $K_0$  from part (b) is definitely not negligible! Liquid crystals in many cases appear to have *strong pinning* boundary conditions, where the relative angle of the order parameter and the surface is fixed by the chemical treatment of the surface. Some terms like  $K_0$  are not included in the bulk energy because they become too *large*; they rigidly constrain the boundary conditions and become otherwise irrelevant.

<sup>20</sup>Such formulæ are used, for example, in path integrals to change the weights of different topological sectors.

<sup>21</sup>The order parameter is the same as the Heisenberg antiferromagnet, but the latter has a symmetry where the order parameter can rotate independently from the spatial rotations, which is not true of liquid crystals.

**(9.4) Domain walls in magnets.** (Condensed matter) ③

The free energy density of an Ising magnet below  $T_c$  can be roughly approximated as a double-well potential (eqn 9.19), with two minima at  $\pm m_0$ :

$$\mathcal{F} = \frac{1}{2}K(\nabla m)^2 + (\mu(T)/2)m^2 + (g/4!)m^4 \quad (9.11)$$

$$= \frac{1}{2}K(\nabla m)^2 + (g/4!)(m^2 - m_0^2)^2. \quad (9.12)$$

This exercise studies the structure of the domain wall separating a region of positive magnetization from one of negative magnetization.

Consider a magnetization  $m(x)$  varying only along the  $x$  direction, with  $m(-\infty) = -m_0$  and  $m(\infty) = m_0$ . In between, it must pass through a barrier region with  $m \approx 0$ . The stiffness  $K$  penalizes sharp gradients in the magnetization;  $g$  penalizes regions with magnetization away from the equilibria at  $\pm m_0$ . In part (a), we give a rough argument for the width of the domain wall, in terms of  $K$ ,  $m_0$ , and  $g$ , by balancing the gradient cost of a thin wall against the barrier cost of a thick wall.

The second term in  $\mathcal{F}$  is a double-wall potential, with a barrier  $B$  separating two wells, with units energy per unit volume. An interface between  $m = -m_0$  and  $m = +m_0$  with width  $\Delta$  will have an energy cost  $\sim B \times \Delta$  per unit area due to the barrier, which wants  $\Delta$  to be as small as possible. The first term in  $\mathcal{F}$  is a stiffness of the order parameter against rapid changes in  $m$ , adding an energy per unit area  $\sim K\Delta \times (m_0/\Delta)^2$ .

(a) *Using these rough estimates find  $B$ , minimize the sum, and give a rough value for the energy per unit area of the domain wall in terms of  $K$ ,  $m_0$ , and  $g$ .*

The rest of this exercise will lead you through a variational calculation of the shape of the domain wall (see [89, chapter 12] for information about the calculus of variations).

(b) *Find the equation satisfied by that  $m(x)$  which minimizes  $F = \int \mathcal{F} dx$ , given the boundary conditions.* (This is the Euler–Lagrange equation from the calculus of variations.)

(c) *Show that the solution  $m(x)$  has the property*

*that the combination*

$$E = (K/2)(\partial m/\partial x)^2 - (g/4!)(m^2 - m_0^2)^2 \quad (9.13)$$

*is independent of  $x$ .* (Hint: What is  $\partial E/\partial x$ ?)

$E$  is analogous to the energy of a particle in an inverted potential well, with  $x$  playing the role of time. The double well becomes a potential with two hills at  $\pm m_0$ . (‘Energy’ conservation comes from the symmetry of the system under translations.) Solving for the minimum  $m(x)$  is finding the classical trajectory in the inverted potential; it rolls down one hill and rolls back up the second one.

(d) *Argue from the boundary conditions that  $E = 0$ . Using that, find the minimum free energy path  $m(x)$  satisfying the boundary conditions  $m(\pm\infty) = \pm m_0$ . Was your wall thickness estimate of part (a) roughly correct?* (Hint: If you know  $dy/dx = f(y)$ , you know  $\int dy/f(y) = \int dx$ .)

**(9.5) Landau theory for the Ising model.** (Condensed matter) ③

This chapter has focused on the topological order parameter, which labels the different ground states of the system when there is a spontaneously broken symmetry. To study the defect cores, interfaces, and high temperatures near phase transitions, one would like an order parameter which can vary in magnitude as well as direction.

In Section 6.7, we explicitly computed a free energy for the ideal gas as a function of the density. Can we use symmetry and gradient expansions to derive free energy densities for more realistic systems—even systems that we do not understand microscopically? Lev Landau used the approach we discuss here to develop theories of magnets, superconductors, and superfluids—before the latter two were understood in microscopic terms.<sup>22</sup> In this exercise, you will develop a Landau<sup>23</sup> theory for the Ising model.<sup>24</sup>

Here we outline the general recipe, and ask you to implement the details for the Ising model. Along the way, we will point out places where the assumptions made in Landau theory can break

<sup>22</sup>Physicists call this Landau theory. Rather similar formalisms have been developed in various other fields of physics and engineering, from liquid crystals to ‘rational mechanics’ treatments of martensites (see Exercises 11.7 and 11.8). The vocabulary is often different (Frank, Ericksen, and Leslie instead of Landau, constitutive relations rather than free energies, and internal state variables rather than order parameters) but the basic approach is similar.

<sup>23</sup>More properly, a Ginsburg–Landau theory, because we include gradient terms in the free energy density, which Landau first did in collaboration with Ginsburg.

<sup>24</sup>See also Exercise 12.5 for a more traditional mean-field theory approach.

down—often precisely in the cases where the theory is most useful.

(1) *Pick an order parameter field.*

Remember that the Ising model had a high-temperature paramagnetic phase with zero magnetization per spin  $m$ , and a low-temperature ferromagnetic phase with a net magnetization per spin  $\pm m(T)$  that went to one at  $T = 0$ . The Ising model picks one of the two equilibrium states (up or down); we say it spontaneously breaks the up-down symmetry of the Hamiltonian

Hence the natural<sup>25</sup> order parameter is the scalar  $m(\mathbf{x})$ , the local magnetization averaged over some volume  $\Delta V$ . This can be done by averaging the magnetization per spin in small boxes, as in Section 6.7.

(a) *What value will  $m(\mathbf{x})$  take at temperatures high compared to the interaction  $J$  in the Ising model? What values will it take at temperatures very low compared to  $J$ ?*

(2) *Write a general local<sup>26</sup> free energy density, for long wavelengths and translational symmetry.*

A local free energy is one which depends on the order parameter field and its gradients:

$$\mathcal{F}^{\text{Ising}}\{m, T\} = \mathcal{F}(\mathbf{x}, m, \partial_j m, \partial_j \partial_k m, \dots). \tag{9.14}$$

As in Section 9.3, we Taylor expand in gradients.<sup>27</sup> Keeping terms with up to two gradients of  $m$  (and, for simplicity, no gradients of temperature), we find

$$\begin{aligned} \mathcal{F}^{\text{Ising}}\{m, T\} = & A(m, T) + V_i(m, T)\partial_i m \\ & + B_{ij}(m, T)\partial_i \partial_j m \\ & + C_{ij}(m, T)(\partial_i m)(\partial_j m). \end{aligned} \tag{9.15}$$

(b) *What symmetry tells us that the unknown functions  $A$ ,  $B$ ,  $C$ , and  $V$  do not depend on position  $\mathbf{x}$ ? If the magnetization varies on a large length scale  $D$ , how much smaller would a term involving three derivatives be than the terms  $B$  and  $C$  that we have kept?*

(3) *Impose the other symmetries of the problem.*

The Ising model has an up-down symmetry<sup>28</sup> so the free energy density  $\mathcal{F}^{\text{Ising}}\{m\} = \mathcal{F}\{-m\}$ . Hence the coefficients  $A$  and  $C$  are functions of  $m^2$ , and the functions  $V_i(m, T) = m v_i(m^2, T)$  and  $B_{ij}(m) = m b_{ij}(m^2, T)$ .

The two-dimensional Ising model on a square lattice is symmetric under  $90^\circ$  rotations. This tells us that  $v_i = 0$  because no vector is invariant under  $90^\circ$  rotations. Similarly,  $b$  and  $C$  must commute with these rotations, and so must be multiples of the identity matrix.<sup>29</sup> Hence we have

$$\begin{aligned} \mathcal{F}^{\text{Ising}}\{m, T\} = & A(m^2, T) + m b(m^2, T)\nabla^2 m \\ & + C(m^2, T)(\nabla m)^2. \end{aligned} \tag{9.16}$$

Many systems are isotropic: the free energy density is invariant under all rotations. For isotropic systems, the material properties (like the functions  $A$ ,  $B_{ij}$ , and  $C_{ij}$  in eqn 9.15) must be invariant under rotations. All terms in a local free energy for an isotropic system must be writable in terms of dot and cross products of the gradients of the order parameter field.

(c) *Would the free energy density of eqn 9.16 change for a magnet that had a continuous rotational symmetry?*

(4) *Simplify using total divergence terms.*

Free energy densities are intrinsically somewhat arbitrary. If one adds to  $\mathcal{F}$  a gradient of any smooth vector function  $\nabla \cdot \boldsymbol{\xi}(m)$ , the integral will differ only by a surface term  $\int \nabla \cdot \boldsymbol{\xi}(m) dV = \int \boldsymbol{\xi}(m) \cdot dS$ .

In many circumstances, surface terms may be ignored. (i) If the system has periodic boundary conditions, then the integral  $\int \boldsymbol{\xi}(m) \cdot dS = 0$  because the opposite sides of the box will cancel. (ii) Large systems will have surface areas which are small compared to their volumes, so the surface terms can often be ignored,  $\int \nabla \cdot \boldsymbol{\xi}(m) dV = \int \boldsymbol{\xi}(m) \cdot dS \sim L^2 \ll \int \mathcal{F} dV \sim L^3$ . (iii) Total divergence terms can be interchanged for changes in the surface free energy, which depends upon the

<sup>25</sup>Landau has a more systematic approach for defining the order parameter, based on group representation theory, which can be quite useful in more complex systems.

<sup>26</sup>Long-range Coulomb, gravitational, or elastic fields can be added to the order parameters. For a complete description the order parameter should incorporate long-range fields, conserved quantities, and all broken symmetries.

<sup>27</sup>A gradient expansion will not be valid at sharp interfaces and in defect cores where the order parameter varies on microscopic length scales. Landau theory is often used anyhow, as a solvable if uncontrolled approximation to the real behavior.

<sup>28</sup>The equilibrium state may not have up-down symmetry, but the model—and hence the free energy density—certainly does.

<sup>29</sup>Under a  $90^\circ$  rotation  $R = \begin{pmatrix} 0 & 1 \\ -1 & 0 \end{pmatrix}$ , a vector  $\mathbf{v}$  goes to  $R \cdot \mathbf{v}$ . For it to be invariant,  $(v_1 \ v_2) = (v_1 \ v_2) \begin{pmatrix} 0 & 1 \\ -1 & 0 \end{pmatrix} = (-v_2, v_1)$ , so  $v_1 = -v_2 = -v_1 = 0$ . An invariant symmetric matrix  $C$  rotates to  $RCR^{-1} = \begin{pmatrix} 0 & 1 \\ -1 & 0 \end{pmatrix} \begin{pmatrix} C_{11} & C_{12} \\ C_{12} & C_{22} \end{pmatrix} \begin{pmatrix} 0 & -1 \\ 1 & 0 \end{pmatrix} = \begin{pmatrix} C_{22} & -C_{12} \\ -C_{12} & C_{11} \end{pmatrix}$  so  $C_{11} = C_{22}$  and  $C_{12} = 0$ , and hence  $C$  is a multiple of the identity.

orientation of the order parameter with respect to the boundary of the sample.<sup>30</sup> This allows us to integrate terms in the free energy by parts; by subtracting a total divergence  $\nabla(uv)$  from the free energy we can exchange a term  $u \nabla v$  for a term  $-v \nabla u$ . For example, we can subtract a term  $-\nabla \cdot (m b(m^2, T) \nabla m)$  from the free energy 9.16:

$$\begin{aligned} \mathcal{F}^{\text{Ising}}\{m, T\} &= A(m^2, T) + m b(m^2, T) \nabla^2 m \\ &\quad + C(m^2, T) (\nabla m)^2 \\ &\quad - \nabla (m b(m^2, T) \cdot \nabla m) \\ &= A(m^2, T) + C(m^2, T) (\nabla m)^2 \\ &\quad - \nabla (m b(m^2, T) \cdot \nabla m) \\ &= A(m^2, T) + C(m^2, T) (\nabla m)^2 \\ &\quad - (b(m^2, T) + 2m^2 b'(m^2, T)) (\nabla m)^2 \\ &= A(m^2, T) \\ &\quad + (C(m^2, T) - b(m^2, T) \\ &\quad \quad - 2m^2 b'(m^2, T)) (\nabla m)^2, \end{aligned} \quad (9.17)$$

replacing  $(m b(m^2, T)) (\nabla^2 m)$  with the equivalent term  $-(\nabla m) (\nabla (m b(m^2, T) \nabla m) \cdot \nabla m)$ . Thus we may absorb the  $b$  term proportional to  $\nabla^2 m$  into an altered  $c = C(m^2, T) - b(m^2, T) - 2m^2 b'(m^2, T)$  term times  $(\nabla m)^2$ :

$$\mathcal{F}^{\text{Ising}}\{m, T\} = A(m^2, T) + c(m^2, T) (\nabla m)^2. \quad (9.18)$$

(5) (Perhaps) assume the order parameter is small.<sup>31</sup>

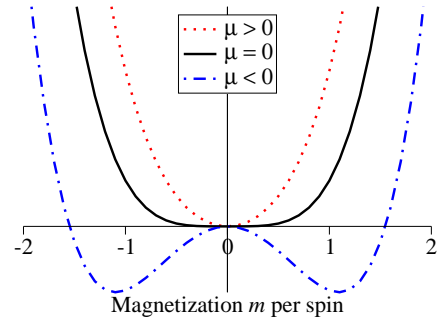
If we assume  $m$  is small, we may Taylor expand  $A$  and  $c$  in powers of  $m^2$ , yielding  $A(m^2, T) = f_0 + (\mu(T)/2)m^2 + (g/4!)m^4$  and  $c(m^2, T) = \frac{1}{2}K$ , leading to the traditional Landau free energy for the Ising model:

$$\mathcal{F}^{\text{Ising}} = \frac{1}{2}K (\nabla m)^2 + f_0 + (\mu(T)/2)m^2 + (g/4!)m^4, \quad (9.19)$$

where  $f_0$ ,  $g$ , and  $K$  can also depend upon  $T$ . (The factors of 1/2 and 1/4! are traditional.)

The free energy density of eqn 9.19 is one of the most extensively studied models in physics. The

field theorists use  $\phi$  instead of  $m$  for the order parameter, and call it the  $\phi^4$  model. Ken Wilson added fluctuations to this model in developing the renormalization group (Chapter 12).



**Fig. 9.22 Landau free energy density** for the Ising model 9.19, at positive, zero, and negative values of the quadratic term  $\mu$ .

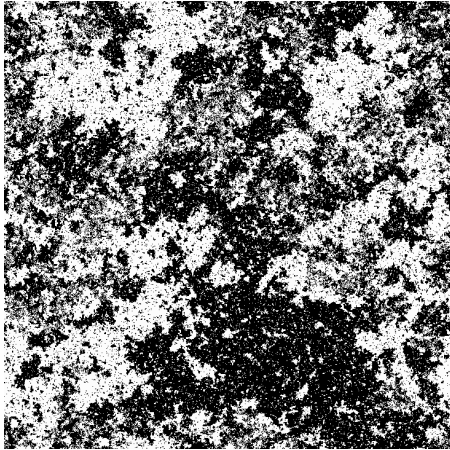
Notice that the Landau free energy density has a qualitative change at  $\mu = 0$ . For positive  $\mu$  it has a single minimum at  $m = 0$ ; for negative  $\mu$  it has two minima at  $m = \pm \sqrt{-6\mu/g}$ . Is this related to the transition in the Ising model from the paramagnetic phase ( $m = 0$ ) to the ferromagnetic phase at  $T_c$ ?

The free energy density already incorporates (by our assumptions) fluctuations in  $m$  on length scales small compared to the coarse-graining length  $W$ . If we ignored fluctuations on scales larger than  $W$  then the free energy of the whole system<sup>32</sup> would be given by the volume times the free energy density, and the magnetization at a temperature  $T$  would be given by minimizing the free energy density. The quadratic term  $\mu(T)$  would vanish at  $T_c$ , and if we expand  $\mu(T) \sim a(T - T_c) + \dots$  we find  $m = \pm \sqrt{6a/g} \sqrt{T_c - T}$  near the critical temperature.

<sup>30</sup>See Exercise 9.3 and [76]. One must also be wary of total divergence terms for systems with topological defects, which count as internal surfaces; see [117].

<sup>31</sup>Notice that this approximation is not valid for abrupt phase transitions, where the order parameter is large until the transition and zero afterward. Landau theories are often used anyhow for abrupt transitions (see Fig. 11.2(a)), and are illuminating if not controlled.

<sup>32</sup>The total free energy is convex (Fig. 11.2(a)). The free energy density  $\mathcal{F}$  in Fig. 9.22 can have a barrier if a boundary between the phases is thicker than the coarse-graining length. The total free energy also has singularities at phase transitions.  $\mathcal{F}$  can be analytic because it is the free energy of a finite region; thermal phase transitions do not occur in finite systems.



**Fig. 9.23 Fluctuations on all scales.** A snapshot of the Ising model at  $T_c$ . Notice that there are fluctuations on all length scales.

This is qualitatively correct, but quantitatively wrong. The magnetization does vanish at  $T_c$  with a power law  $m \sim (T_c - T)^\beta$ , but the exponent  $\beta$  is not generally  $1/2$ ; in two dimensions it is  $\beta_{2D} = 1/8$  and in three dimensions it is  $\beta_{3D} \approx 0.325$ . These exponents (particularly the presumably irrational one in 3D) cannot be fixed by keeping more or different terms in the analytic Landau expansion.

(d) Show that the power-law  $\beta_{\text{Landau}} = 1/2$  is not changed in the limit  $T \rightarrow T_c$  even when one adds another term  $(h/6!)m^6$  into eqn 9.19. (That is, show that  $m(T)/(T - T_c)^\beta$  goes to a constant as  $T \rightarrow T_c$ .) (Hint: You should get a quadratic equation for  $m^2$ . Keep the root that vanishes at  $T = T_c$ , and expand in powers of  $h$ .) Explore also the alternative phase transition where  $g \equiv 0$  but  $h > 0$ ; what is  $\beta$  for that transition?

As we see in Fig. 9.23 there is no length  $W$  above which the Ising model near  $T_c$  looks smooth and uniform. The Landau free energy density gets corrections on all length scales; for the infinite system the free energy has a singularity at  $T_c$  (making our power-series expansion for  $\mathcal{F}^{\text{Ising}}$  inadequate). The Landau free energy density is only a starting-point for studying continuous phase transitions;<sup>33</sup> we must use the renormalization-group methods of Chapter 12 to explain and predict these singularities.

### (9.6) Symmetries and wave equations. ③

We can use symmetries and gradient expansions not only for deriving new free energies (Exercise 9.5), but also for directly deriving equations of motion. This approach (sometimes including fluctuations) has been successful in a number of systems that are strongly out of equilibrium [58, 65, 139]. In this exercise, you will derive the equation of motion for a scalar order parameter  $y(x, t)$  in a one-dimensional system. Our order parameter might represent the height of a string vibrating vertically, or the horizontal displacement of a one-dimensional crystal, or the density of particles in a one-dimensional gas.

Write the most general possible law. We start by writing the most general possible evolution law. Such a law might give the time derivative  $\partial y/\partial t = \dots$  like the diffusion equation, or the acceleration  $\partial^2 y/\partial t^2 = \dots$  like the wave equation, or something more general. If we take the left-hand side minus the right-hand side, we can write any equation of motion in terms of some (perhaps nonlinear) function  $\mathcal{G}$  involving various partial derivatives of the function  $y(x, t)$ :

$$\mathcal{G}\left(y, \frac{\partial y}{\partial x}, \frac{\partial y}{\partial t}, \frac{\partial^2 y}{\partial x^2}, \frac{\partial^2 y}{\partial t^2}, \frac{\partial^2 y}{\partial x \partial t}, \dots, \frac{\partial^7 y}{\partial x^3 \partial t^4}, \dots\right) = 0. \quad (9.20)$$

Notice that we have already assumed that our system is homogeneous and time independent; otherwise  $\mathcal{G}$  would explicitly depend on  $x$  and  $t$  as well.

First, let us get a tangible idea of how a function  $\mathcal{G}$  can represent an equation of motion, say the diffusion equation.

(a) What common equation of motion results from the choice  $\mathcal{G}(a_1, a_2, \dots) = a_3 - Da_4$  in eqn 9.20?

Restrict attention to long distances and times: gradient expansion. We are large and slow creatures. We will perceive only those motions of the system that have long wavelengths and low frequencies. Every derivative with respect to time (space) divides our function by a characteristic time scale (length scale). By specializing our equations to long length and time scales, let us drop all terms with more than two derivatives (everything after the dots in eqn 9.20). We will also

<sup>33</sup>An important exception to this is superconductivity, where the Cooper pairs are large compared to their separation. Because they overlap so many neighbors, the fluctuations in the order parameter field are suppressed, and Landau theory is valid even very close to the phase transition.

assume that  $\mathcal{G}$  can be written as a sum of products of its arguments—that it is an *analytic* function of  $y$  and its gradients. This implies that

$$f + g \frac{\partial y}{\partial t} + h \frac{\partial y}{\partial x} + i \left( \frac{\partial y}{\partial t} \right)^2 + \dots + n \frac{\partial^2 y}{\partial t \partial x} = 0, \tag{9.21}$$

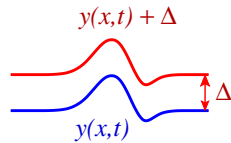
where  $f, g, \dots, n$  are general analytic functions of  $y$ .

(b) Give the missing terms, multiplying functions  $j(y), k(y), \dots, m(y)$ .

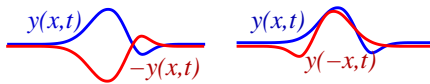
Apply the symmetries of the system.

We will assume that our system is like waves on a string, or one-dimensional phonons, where an overall shift of the order parameter  $y \rightarrow y + \Delta$  is a symmetry of the system (Fig. 9.24). This implies that  $\mathcal{G}$ , and hence  $f, g, \dots, n$ , are independent of  $y$ .

Let us also assume that our system is invariant under flipping the sign of the order parameter  $y \rightarrow -y$ , and to spatial inversion, taking  $x \rightarrow -x$  (Fig. 9.25). More specifically, we will keep all terms in eqn 9.21 which are *odd* under flipping the sign of the order parameter and *even* under inversion.<sup>34</sup>



**Fig. 9.24 Shift symmetry.** We assume our system is invariant under overall shifts in the order parameter field. Hence, if  $y(x, t)$  is a solution, so is  $y(x, t) + \Delta$ .



**Fig. 9.25 Flips and inversion.** We assume our system is invariant under flipping ( $y \rightarrow -y$ ) and inversion ( $x \rightarrow -x$ ). Hence, if  $y(x, t)$  is a solution, so are  $y(-x, t)$  and  $-y(x, t)$ .

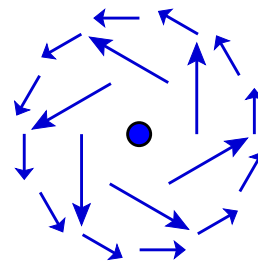
(c) Which three terms in eqn 9.21 are left after imposing these symmetries? Which one is not part of the wave equation  $\partial^2 y / \partial t^2 = c^2 \partial^2 y / \partial x^2$ ?

This third term would come from a source of friction. For example, if the vibrating string was embedded in a fluid (like still air), then slow vibrations (low Reynolds numbers) would be damped by a term like the one allowed by symmetry in part (c). Systems with *time inversion* symmetry cannot have dissipation, and you can check that your term changes sign as  $t \rightarrow -t$ , where the other terms in the wave equation do not.

This third term would not arise if the vibrating string is in a vacuum. In particular, it is not *Galilean invariant*. A system has Galilean invariance if it is unchanged under *boosts*: for any solution  $y(x, t)$ ,  $y(x, t) + vt$  is also a solution.<sup>35</sup> The surrounding fluid stays at rest when our vibrating string gets boosted, so the resulting friction is not Galilean invariant. On the other hand, internal friction due to bending and flexing the string is invariant under boosts. This kind of friction is described by *Kelvin damping* (which you can think of as a dashpot in parallel with the springs holding the material together).

(d) Show that your third term is not invariant under boosts. Show that the Kelvin damping term  $\partial^3 y / \partial t \partial x^2$  is invariant under boosts and transforms like the terms in the wave equation under shifts, flips, and inversion.

(9.7) **Superfluid order and vortices.** (Quantum, Condensed matter) ③



**Fig. 9.26 Superfluid vortex line.** Velocity flow  $\mathbf{v}(\mathbf{x})$  around a superfluid vortex line.

<sup>34</sup>All terms in the equation of motion must have the same dependence on a symmetry of the system. One could concoct inversion-symmetric physical systems whose equation of motion involved terms odd under inversion.

<sup>35</sup>This is a non-relativistic version of *Lorentz invariance*.

Superfluidity in helium is closely related to Bose condensation of an ideal gas; the strong interactions between the helium atoms quantitatively change things, but many properties are shared. In particular, we describe the superfluid in terms of a complex number  $\psi(\mathbf{r})$ , which we think of as a wavefunction which is occupied by a large fraction of all the atoms in the fluid.

(a) If  $N$  non-interacting bosons reside in a state  $\chi(\mathbf{r})$ , write an expression for the net current density  $J(\mathbf{r})$ .<sup>36</sup> Write the complex field  $\chi(\mathbf{r})$  in terms of an amplitude and a phase,  $\chi(\mathbf{r}) = |\chi(\mathbf{r})| \exp(i\phi(\mathbf{r}))$ . We write the superfluid density as  $n_s = N|\chi|^2$ . Give the current  $J$  in terms of  $\phi$  and  $n_s$ . What is the resulting superfluid velocity,  $v = J/n_s$ ? (It should be independent of  $n_s$ .)

The Landau order parameter in superfluids  $\psi(\mathbf{r})$  is traditionally normalized so that the amplitude is the square root of the superfluid density; in part (a),  $\psi(\mathbf{r}) = \sqrt{N}\chi(\mathbf{r})$ .

In equilibrium statistical mechanics, the macroscopically occupied state is always the ground state, which is real and hence has no current. We can form non-equilibrium states, however, which macroscopically occupy other quantum states. For example, an experimentalist might cool a container filled with helium while it is moving; the ground state in the moving reference frame has a current in the unmoving laboratory frame. More commonly, the helium is prepared in a rotating state.

(b) Consider a torus filled with an ideal Bose gas at  $T = 0$  with the hole along the vertical axis; the superfluid is condensed into a state which is rotating around the hole. Using your formula from part (a) and the fact that  $\phi + 2n\pi$  is indistinguishable from  $\phi$  for any integer  $n$ , show that the circulation  $\oint v \cdot d\mathbf{r}$  around the hole is quantized. What is the quantum of circulation?

Superfluid helium cannot swirl except in quantized units! Notice that you have now explained why superfluids have no viscosity. The velocity around the torus is quantized, and hence it cannot decay continuously to zero; if it starts swirling with non-zero  $n$  around the torus, it must swirl forever.<sup>37</sup> This is why we call them superfluids. In bulk helium this winding number labels line

defects called *vortex lines*.

(c) Treat  $\phi(\mathbf{r})$ , the phase of the superconducting wavefunction, as the topological order parameter of the superfluid. Is the order parameter a closed loop,  $\mathbb{S}^1$ ? Classify the types of vortex lines in a superfluid. (That is, either give the first homotopy group of the order parameter space, or give the allowed values of the quantized circulation around a vortex.)

### (9.8) Superfluids: density matrices and ODLRO. (Condensed matter, Quantum) ⑤

This exercise develops the quantum theory of the order parameters for superfluids and superconductors, following classic presentations by Anderson [5, 6]. We introduce the reduced density matrix, off-diagonal long-range order, broken gauge symmetry, and deduce that a subvolume of a superfluid is best described as a superposition of states with different numbers of particles. The exercise is challenging; it assumes more quantum mechanics than the rest of the text, it involves technically challenging calculations, and the concepts it introduces are deep and subtle. . .

*Density matrices.* We saw in Exercise 9.7 that a Bose-condensed ideal gas can be described in terms of a complex number  $\psi(\mathbf{r})$  representing the eigenstate which is macroscopically occupied. For superfluid helium, the atoms are in a strongly-interacting liquid state when it goes superfluid. We can define the order parameter  $\psi(\mathbf{r})$  even for an interacting system using the *reduced density matrix*.

Suppose our system is in a mixture of many-body states  $\Psi_\alpha$  with probabilities  $P_\alpha$ . The full density matrix in the position representation, you will remember, is

$$\begin{aligned} \hat{\rho}(\mathbf{r}'_1, \dots, \mathbf{r}'_N, \mathbf{r}_1, \dots, \mathbf{r}_N) \\ = \sum_{\alpha} P_{\alpha} \Psi_{\alpha}^{*}(\mathbf{r}'_1, \dots, \mathbf{r}'_N) \Psi(\mathbf{r}_1, \dots, \mathbf{r}_N). \end{aligned} \quad (9.22)$$

(Properly speaking, these are the matrix elements of the density matrix in the position representation; rows are labeled by  $\{\mathbf{r}'_i\}$ , columns are labeled by  $\{\mathbf{r}_j\}$ .) The reduced density matrix  $\hat{\rho}(\mathbf{r}', \mathbf{r})$  (which I will call the density matrix hereafter) is

<sup>36</sup>You can use the standard quantum mechanics single-particle expression  $J = (i\hbar/2m)(\psi\nabla\psi^* - \psi^*\nabla\psi)$  and multiply by the number of particles, or you can use the many-particle formula  $J(\mathbf{r}) = (i\hbar/2m) \int d^3\mathbf{r}_1 \dots d^3\mathbf{r}_N \sum_{\ell} \delta(\mathbf{r}_{\ell} - \mathbf{r})(\Psi\nabla_{\ell}\Psi^* - \Psi^*\nabla_{\ell}\Psi)$  and substitute in the condensate wavefunction  $\Psi(\mathbf{r}_1, \dots, \mathbf{r}_N) = \prod_n \chi(\mathbf{r}_n)$ .

<sup>37</sup>Or at least until a dramatic event occurs which changes  $n$ , like a vortex line passing across the torus, demanding an activation energy proportional to the width of the torus. See also Exercise 7.9.

given by setting  $\mathbf{r}'_j = \mathbf{r}_j$  for all but one of the particles and integrating over all possible positions, multiplying by  $N$ :

$$\begin{aligned} \widehat{\rho}_2(\mathbf{r}', \mathbf{r}) = & \\ N \int & d^3r_2 \cdots d^3r_N \\ & \times \widehat{\rho}(\mathbf{r}', \mathbf{r}_2, \dots, \mathbf{r}_N, \mathbf{r}, \mathbf{r}_2, \dots, \mathbf{r}_N). \end{aligned} \quad (9.23)$$

(For our purposes, the fact that it is called a matrix is not important; think of  $\widehat{\rho}_2$  as a function of two variables.)

(a) *What does the reduced density matrix  $\rho_2(\mathbf{r}', \mathbf{r})$  look like for a zero-temperature Bose condensate of non-interacting particles, condensed into a normalized single-particle state  $\chi(\mathbf{r})$ ?*

An alternative, elegant formulation for this density matrix is to use second-quantized creation and annihilation operators instead of the many-body wavefunctions. These operators  $a^\dagger(\mathbf{r})$  and  $a(\mathbf{r})$  add and remove a boson at a specific place in space. They obey the commutation relations

$$\begin{aligned} [a(\mathbf{r}), a^\dagger(\mathbf{r}')] &= \delta(\mathbf{r} - \mathbf{r}'), \\ [a(\mathbf{r}), a(\mathbf{r}')] &= [a^\dagger(\mathbf{r}), a^\dagger(\mathbf{r}')] = 0; \end{aligned} \quad (9.24)$$

since the vacuum has no particles, we also know

$$\begin{aligned} a(\mathbf{r})|0\rangle &= 0, \\ \langle 0|a^\dagger(\mathbf{r}) &= 0. \end{aligned} \quad (9.25)$$

We define the ket wavefunction as

$$\begin{aligned} |\Psi\rangle &= (1/\sqrt{N!}) \int d^3r_1 \cdots d^3r_N \\ & \times \Psi(\mathbf{r}_1, \dots, \mathbf{r}_N) a^\dagger(\mathbf{r}_1) \cdots a^\dagger(\mathbf{r}_N) |0\rangle. \end{aligned} \quad (9.26)$$

(b) *Show that the ket is normalized if the symmetric Bose wavefunction  $\Psi$  is normalized.* (Hint: Use eqn 9.24 to pull the  $a$ s to the right through the  $a^\dagger$ s in eqn 9.26; you should get a sum of  $N!$  terms, each a product of  $N$   $\delta$ -functions, setting different permutations of  $\mathbf{r}_1 \cdots \mathbf{r}_N$  equal to  $\mathbf{r}'_1 \cdots \mathbf{r}'_N$ .) *Show that  $\langle \Psi | a^\dagger(\mathbf{r}') a(\mathbf{r}) | \Psi \rangle$ , the overlap of  $a(\mathbf{r}) | \Psi \rangle$  with  $a(\mathbf{r}') | \Psi \rangle$  for the pure state  $|\Psi\rangle$  gives the the reduced density matrix 9.23.*

Since this is true of all pure states, it is true of mixtures of pure states as well; hence the reduced density matrix is the same as the expectation value  $\langle a^\dagger(\mathbf{r}') a(\mathbf{r}) \rangle$ .

In a non-degenerate Bose gas, in a system with Maxwell–Boltzmann statistics, or in a Fermi system, one can calculate  $\widehat{\rho}_2(\mathbf{r}', \mathbf{r})$  and show that it rapidly goes to zero as  $|\mathbf{r}' - \mathbf{r}| \rightarrow \infty$ . This makes sense; in a big system,  $a(\mathbf{r}) | \Psi(\mathbf{r}) \rangle$  leaves a state with a missing particle localized around  $\mathbf{r}$ , which will have no overlap with  $a(\mathbf{r}') | \Psi \rangle$  which has a missing particle at the distant place  $\mathbf{r}'$ .

*ODLRO and the superfluid order parameter.* This is no longer true in superfluids; just as in the condensed Bose gas of part (a), interacting, finite-temperature superfluids have a reduced density matrix with off-diagonal long-range order (ODLRO);

$$\widehat{\rho}_2(\mathbf{r}', \mathbf{r}) \rightarrow \psi^*(\mathbf{r}') \psi(\mathbf{r}) \quad \text{as } |\mathbf{r}' - \mathbf{r}| \rightarrow \infty. \quad (9.27)$$

It is called long-range order because there are correlations between distant points; it is called off-diagonal because the diagonal of this density matrix in position space is  $\mathbf{r} = \mathbf{r}'$ . The order parameter for the superfluid is  $\psi(\mathbf{r})$ , describing the long-range piece of this correlation.

(c) *What is  $\psi(\mathbf{r})$  for the non-interacting Bose condensate of part (a), in terms of the condensate wavefunction  $\chi(\mathbf{r})$ ?*

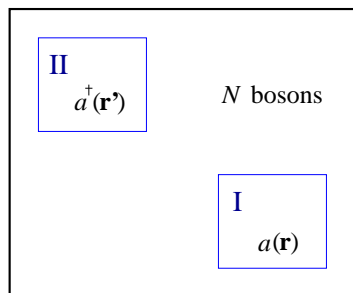
This reduced density matrix is analogous in many ways to the density–density correlation function for gases  $C(\mathbf{r}', \mathbf{r}) = \langle \rho(\mathbf{r}') \rho(\mathbf{r}) \rangle$  and the correlation function for magnetization  $\langle M(\mathbf{r}') M(\mathbf{r}) \rangle$  (Chapter 10). The fact that  $\widehat{\rho}_2$  is long range is analogous to the fact that  $\langle M(\mathbf{r}') M(\mathbf{r}) \rangle \sim \langle M \rangle^2$  as  $\mathbf{r}' - \mathbf{r} \rightarrow \infty$ ; the long-range order in the direction of magnetization is the analog of the long-range phase relationship in superfluids.

*Number conservation and  $\psi$ .* Figure 9.27 illustrates the fact that the local number of particles in a subvolume of a superfluid is indeterminate. Our ground state locally violates conservation of particle number.<sup>38</sup> If the number of particles in a local region is not well defined, perhaps we can think of the local state as some kind of superposition of states with different particle number? Then we could imagine factoring the off-diagonal long-range order  $\langle a^\dagger(\mathbf{r}') a(\mathbf{r}) \rangle \sim \psi^*(\mathbf{r}') \psi(\mathbf{r})$  into  $\langle a^\dagger(\mathbf{r}') \rangle \langle a(\mathbf{r}) \rangle$ , with  $\psi(\mathbf{r}) = \langle a \rangle$ . (This is zero in a closed system, since  $a(\mathbf{r})$  changes the total number of particles.) The immediate question is how to set the relative phases of the parts of the wavefunction with differing numbers of particles. Let us consider a region small enough that we can ig-

<sup>38</sup>This is not just the difference between canonical and grand canonical ensembles. Grand canonical ensembles are probability mixtures between states of different numbers of particles; superfluids have a coherent superposition of wavefunctions with different numbers of particles.



nore the spatial variations.



**Fig. 9.27 Delocalization and ODLRO.** Particles in superfluids are delocalized: the number of particles in a subvolume is not well defined. Annihilating a boson at  $\mathbf{r}$  in region I, insofar as the boson comes out of the condensate, is equivalent to annihilating it at  $\mathbf{r}'$ . The probability overlap between these two states is precisely  $\hat{\rho}_2(\mathbf{r}', r) = \psi^*(\mathbf{r}')\psi(\mathbf{r})$ .

(d) Consider a zero-temperature Bose condensate of  $N$  non-interacting particles in a local region. Let the state into which the bosons condense,  $\chi(\mathbf{r}) = \chi = |\chi|\exp(i\phi)$ , be spatially uniform. What is the phase of the  $N$ -particle Bose-condensed state?

The phase  $\exp(i\phi(\mathbf{r}))$  is the relative phase between the components of the local Bose condensates with  $N$  and  $N - 1$  particles. The superfluid state is a coherent superposition of states with different numbers of particles in local regions. How odd!

Momentum conservation comes from translational symmetry; energy conservation comes from time translational symmetry; angular momentum conservation comes from rotational symmetry. What symmetry leads to number conservation?

(e) Consider the Hamiltonian  $\mathcal{H}$  for a system that conserves the total number of particles, written in second quantized form (in terms of creation and annihilation operators). Argue that the Hamiltonian is invariant under a global symmetry which multiplies all of the creation operators by  $\exp(i\zeta)$  and the annihilation operators by  $\exp(-i\zeta)$ . (This amounts to changing the phases of the  $N$ -particle parts of the wavefunction by  $\exp(iN\zeta)$ . Hint: Note that all terms in  $\mathcal{H}$  have an equal number of creation and annihilation operators.)

The magnitude  $|\psi(\mathbf{r})|^2$  describes the superfluid density  $n_s$ . As we saw above,  $n_s$  is the whole density for a zero-temperature non-interacting Bose gas; it is about one per cent of the density for superfluid helium, and about  $10^{-8}$  for superconductors. If we write  $\psi(\mathbf{r}) = \sqrt{n_s(\mathbf{r})}\exp(i\phi(\mathbf{r}))$ , then the phase  $\phi(\mathbf{r})$  labels which of the broken-symmetry ground states we reside in.<sup>39</sup>

*Broken gauge invariance.* We can draw a deep connection with quantum electromagnetism by promoting this global symmetry into a local symmetry. Consider the effects of shifting  $\psi$  by a spatially-dependent phase  $\zeta(x)$ . It will not change the potential energy terms, but will change the kinetic energy terms because they involve gradients. Consider the case of a single-particle pure state. Our wavefunction  $\chi(x)$  changes into  $\tilde{\chi} = \exp(i\zeta(x))\chi(x)$ , and  $[p^2/2m]\tilde{\chi} = [(\hbar/i)\nabla]^2/2m]\tilde{\chi}$  now includes terms involving  $\nabla\zeta$ .

(f) Show that this single-particle Hamiltonian is invariant under a transformation which changes the phase of the wavefunction by  $\exp(i\zeta(x))$  and simultaneously replaces  $p$  with  $p - \hbar\nabla\zeta$ .

This invariance under multiplication by a phase is closely related to gauge invariance in electromagnetism. Remember in classical electromagnetism the vector potential  $\mathbf{A}$  is arbitrary up to adding a gradient of an arbitrary function  $\Lambda$ : changing  $\mathbf{A} \rightarrow \mathbf{A} + \nabla\Lambda$  leaves the magnetic field unchanged, and hence does not change anything physical. There choosing a particular  $\Lambda$  is called choosing a *gauge*, and this arbitrariness is called *gauge invariance*. Also remember how we incorporate electromagnetism into the Hamiltonian for charged particles: we change the kinetic energy for each particle of charge  $q$  to  $(p - (q/c)A)^2/2m$ , using the ‘covariant derivative’  $(\hbar/i)\nabla - (q/c)A$ . In quantum electrodynamics, particle number is not conserved, but charge is conserved. Our local symmetry, stemming from number conservation, is analogous to the symmetry of electrodynamics when we multiply the wavefunction by  $\exp(i(q/c)\zeta(x))$ , where  $q = -e$  is the charge on an electron.

(g) Consider the Hamiltonian for a charged particle in a vector potential  $H = ((\hbar/i)\nabla - (q/c)A)^2/2m + V(x)$ . Show that this Hamiltonian is preserved under a transformation which multiplies the wavefunction by  $\exp(i(q/e)\zeta(x))$  and

<sup>39</sup> $\psi(\mathbf{r})$  is the Landau order parameter; the phase  $\phi(\mathbf{r})$  is the topological order parameter.

*performs a suitable gauge transformation on  $A$ . What is the required gauge transformation?*

To summarize, we found that superconductivity leads to a state with a local indeterminacy in the number of particles. We saw that it is natural to describe local regions of superfluids as coherent superpositions of states with different numbers of particles. The order parameter  $\psi(\mathbf{r}) = \langle a(\mathbf{r}) \rangle$  has amplitude given by the square root of the superfluid density, and a phase  $\exp(i\phi(\mathbf{r}))$  giving the relative quantum phase between states with different numbers of particles. We saw that the Hamiltonian is symmetric under uniform changes of  $\phi$ ; the superfluid ground state breaks this

symmetry just as a magnet might break rotational symmetry. Finally, we saw that promoting this global symmetry to a local one demanded changes in the Hamiltonian completely analogous to gauge transformations in electromagnetism; number conservation comes from a gauge symmetry. Superfluids spontaneously break gauge symmetry!

In [5, 6] you can find more along these lines. In particular, number  $N$  and phase  $\phi$  turn out to be conjugate variables. The implied equation  $i\hbar\dot{N} = [\mathcal{H}, N] = i\partial\mathcal{H}/\partial\phi$  gives the Josephson current, and is also related to the equation for the superfluid velocity we derived in Exercise 9.7.

# Correlations, response, and dissipation

## 10

In this chapter, we study how systems wiggle, and how they yield and dissipate energy when kicked.<sup>1</sup>

A material in thermal equilibrium may be macroscopically homogeneous and static, but it wiggles on the microscale from thermal fluctuations. We measure how systems wiggle and evolve in space and time using *correlation functions*. In Section 10.1 we introduce correlation functions, and in Section 10.2 we note that scattering experiments (of X-rays, neutrons, and electrons) directly measure correlation functions. In Section 10.3 we use statistical mechanics to calculate equal-time correlation functions using the ideal gas as an example. In Section 10.4 we use Onsager's *regression hypothesis* to derive the time-dependent correlation function.

We often want to know how a system behaves when kicked in various fashions. *Linear response theory* is a broad, systematic method developed for equilibrium systems in the limit of gentle kicks. We can use statistical mechanics to calculate the response when a system is kicked by elastic stress, electric fields, magnetic fields, acoustic waves, or light. The space-time-dependent linear response to the space-time dependent influence is described in each case by a *susceptibility* (Section 10.5).

There are powerful relationships between the wiggling, yielding,<sup>2</sup> and dissipation in an equilibrium system. In Section 10.6 we show that yielding and dissipation are precisely the real and imaginary parts of the susceptibility. In Section 10.7 we show that the static susceptibility is proportional to the equal-time correlation function. In Section 10.8 we derive the *fluctuation-dissipation theorem*, giving the dynamic susceptibility in terms of the time-dependent correlation function. Finally, in Section 10.9 we use causality (the fact that the response cannot precede the perturbation) to derive the *Kramers-Krönig* relation, relating the real and imaginary parts of the susceptibility (yielding and dissipation).

10.1 Correlation functions: motivation	215
10.2 Experimental probes of correlations	217
10.3 Equal-time correlations in the ideal gas	218
10.4 Onsager's regression hypothesis and time correlations	220
10.5 Susceptibility and linear response	222
10.6 Dissipation and the imaginary part	223
10.7 Static susceptibility	224
10.8 The fluctuation-dissipation theorem	227
10.9 Causality and Kramers-Krönig	229

<sup>1</sup>More information on these topics can be found in the classical context in [27, chapter 8], and for quantum systems in [43, 88].

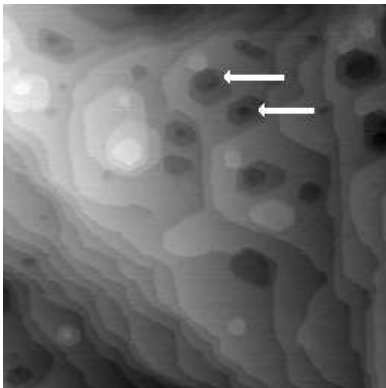
<sup>2</sup>We use 'yielding' informally for the in-phase, reactive response (Section 10.6), for which there appears not to be a standard term.

## 10.1 Correlation functions: motivation

We have learned how to derive the laws giving the equilibrium states of a system and the evolution laws of systems as they approach equilibrium (Figs 10.1 and 10.2). How, though, do we characterize the resulting behavior? How do we extract from our ensemble of systems some testable



**Fig. 10.1 Phase separation** in an Ising model, quenched (abruptly cooled) from high temperatures to zero temperature [124]. The model quickly separates into local blobs of up- and down-spins, which grow and merge, coarsening to larger blob sizes (Section 11.4.1).



**Fig. 10.2 Surface annealing.** An STM image of a surface, created by bombarding a close-packed gold surface with noble-gas atoms, and then allowing the irregular surface to thermally relax (Tatjana Curcic and Barbara H. Cooper [32]). The figure shows individual atomic-height steps; the arrows each show a single step pit inside another pit. The characteristic sizes of the pits and islands grow as the surface evolves and flattens.

<sup>3</sup>We will discuss coarsening in more detail in Section 11.4.1.

numbers or functions (measuring the patterns in space and time) that we can use to compare experiment and theory?

Figure 10.1 is the Ising model at low temperature, showing the spin  $S(\mathbf{x}, t)$  at position  $\mathbf{x}$  and time  $t$ ; the up-spin and down-spin regions are competing [124] to determine which will take over as the broken-symmetry ground state. Figure 10.2 is a gold surface that is thermally flattening from an irregular initial shape [32], showing the height  $h(\mathbf{x}, t)$ . These visual images incorporate a full, rich description of individual members of the ensemble of models—but it is hard to quantify whether experiments and theory agree by comparing snapshots of a random environment. In these two evolving systems, we might quantify the evolution with a measure of the typical feature size as a function of time. Figure 10.3 shows the Ising model at  $T_c$ , where fluctuations occur on all length and time scales. In this equilibrium system we might want a function that describes how likely a black region will extend a distance  $\mathbf{r}$ , or survive for a time  $\tau$ .

We typically measure the space and time coherence in a system using *correlation functions*. Consider the alignment of two Ising spins  $S(\mathbf{x}, t)$  and  $S(\mathbf{x} + \mathbf{r}, t)$  in the coarsening figure (Fig. 10.1); spins at the same time  $t$ , but separated by a distance  $\mathbf{r}$ . If  $|\mathbf{r}|$  is much larger than a typical blob size  $L(t)$ , the spins will have a 50/50 chance of being aligned or misaligned, so their average product will be near zero. If  $|\mathbf{r}|$  is much smaller than a typical blob size  $L$ , the spins will typically be aligned parallel to one another (both  $+1$  or both  $-1$ ), so their average product will be near one. The equal-time spin-spin correlation function

$$C_t^{\text{coar}}(\mathbf{r}) = \langle S(\mathbf{x}, t)S(\mathbf{x} + \mathbf{r}, t) \rangle \quad (10.1)$$

will go from one at  $\mathbf{r} = \mathbf{0}$  to zero at  $|\mathbf{r}| \gg L(t)$ , and will cross  $1/2$  at a characteristic blob size  $L(t)$ . In non-equilibrium problems like this one, the system is evolving in time, so the equal-time correlation function also evolves.<sup>3</sup>

The correlation function in general contains more information than just the typical blob size. Consider the equilibrium correlation function, say for the Ising model

$$C(\mathbf{r}, \tau) = \langle S(\mathbf{x}, t)S(\mathbf{x} + \mathbf{r}, t + \tau) \rangle. \quad (10.2)$$

The *equal-time* correlation function  $C(\mathbf{r}, 0)$  contains information about how much a spin influences its distant neighbors. Even at high temperatures, if a spin is up its immediate neighbors are more likely to point up than down. As the temperature approaches the ferromagnetic transition temperature  $T_c$ , this preference extends to further neighbors (Fig. 10.4). Below  $T_c$  we have *long-range order*; even very distant neighbors will tend to align with our spin, since the two broken-symmetry equilibrium states each have net magnetization per spin  $m$ . Above  $T_c$  the equal-time correlation function goes to zero at long distances  $r$ ; below  $T_c$  it goes to  $m^2$ , since the fluctuations of two distant spins about the mean magnetization become uncorrelated:

$$C(\infty, 0) = \lim_{r \rightarrow \infty} \langle S(\mathbf{x}, t)S(\mathbf{x} + \mathbf{r}, t) \rangle = \langle S(\mathbf{x}, t) \rangle \langle S(\mathbf{x} + \mathbf{r}, t) \rangle = m^2. \quad (10.3)$$

What happens at the critical temperature? At  $T_c$  the equal-time correlation function decays as a power law  $C(\mathbf{r}, 0) \sim r^{-(d-2+\eta)}$  at long distances (Fig. 10.5), representing the fact that there are correlations at all length scales (a compromise between short- and infinite-range order). Similarly, the (equal-position) spin-spin correlation function  $C(\mathbf{0}, \tau) = \langle s(t)s(t+\tau) \rangle$  at long times  $\tau$  goes to zero for  $T > T_c$ , to  $m^2$  for  $T < T_c$ , and at  $T_c$  decays as a power law with a different exponent  $C(\mathbf{0}, \tau) \sim \tau^{-(d-2+\eta)/z}$ . We will see how to explain these power laws in Chapter 12, when we study continuous phase transitions.

In other systems, one might study the atomic density–density correlation functions  $C(\mathbf{r}, \tau) = \langle \rho(\mathbf{x} + \mathbf{r}, t + \tau)\rho(\mathbf{x}, t) \rangle$ ,<sup>4</sup> or the height–height correlation function for a surface (Fig. 10.2), or the phase–phase correlations of the superfluid order parameter, ...

## 10.2 Experimental probes of correlations

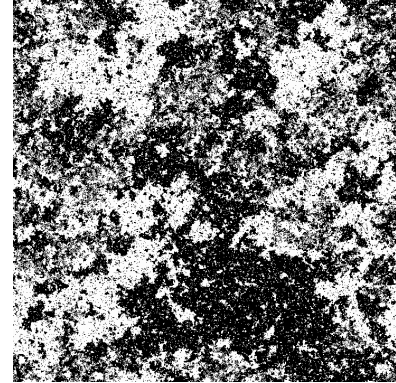
Many scattering experiments directly measure correlation functions. X-rays measure the electron density–density correlation function, neutrons can measure spin-spin correlation functions, and so on. Elastic scattering gives the equal-time correlation functions, while inelastic scattering can give the time-dependent correlation functions.

Let us briefly summarize how this works for X-ray elastic scattering. In X-ray diffraction<sup>5</sup> (Fig. 10.6) a plane-wave beam of wavevector  $\mathbf{k}_0$  scatters off of the sample, with the emitted radiation along wavevector  $\mathbf{k}_0 + \mathbf{k}$  proportional to  $\tilde{\rho}_e(\mathbf{k})$ , the Fourier transform of the electron density  $\rho_e(\mathbf{x})$  in the sample. The intensity of the scattered beam  $|\tilde{\rho}_e(\mathbf{k})|^2$  can be measured, for example, by exposing photographic film. But this intensity is given by the Fourier transform of the equal-time electron–density–density correlation function  $C_{ee}(\mathbf{r}) = \langle \rho_e(\mathbf{x} + \mathbf{r}, t)\rho_e(\mathbf{x}, t) \rangle$  (eqn A.21):

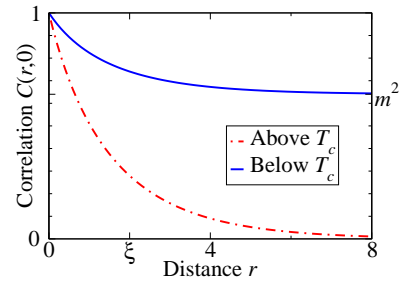
$$\begin{aligned} |\tilde{\rho}(\mathbf{k})|^2 &= \tilde{\rho}(\mathbf{k})^* \tilde{\rho}(\mathbf{k}) = \int d\mathbf{x}' e^{i\mathbf{k}\cdot\mathbf{x}'} \rho(\mathbf{x}') \int d\mathbf{x} e^{-i\mathbf{k}\cdot\mathbf{x}} \rho(\mathbf{x}) \\ &= \int d\mathbf{x} d\mathbf{x}' e^{-i\mathbf{k}\cdot(\mathbf{x}-\mathbf{x}')} \rho(\mathbf{x}') \rho(\mathbf{x}) \\ &= \int d\mathbf{r} e^{-i\mathbf{k}\cdot\mathbf{r}} \int d\mathbf{x}' \rho(\mathbf{x}') \rho(\mathbf{x}' + \mathbf{r}) \\ &= \int d\mathbf{r} e^{-i\mathbf{k}\cdot\mathbf{r}} V \langle \rho(\mathbf{x}) \rho(\mathbf{x} + \mathbf{r}) \rangle = V \int d\mathbf{r} e^{-i\mathbf{k}\cdot\mathbf{r}} C(\mathbf{r}) \\ &= V \tilde{C}(\mathbf{k}). \end{aligned} \quad (10.4)$$

In the same way, other scattering experiments also measure two-point correlation functions, averaged over the entire illuminated sample.

Real-space microscopy experiments and  $k$ -space diffraction experiments provide complementary information about a system. The real-space images are direct and easily appreciated and comprehended by the human mind. They are invaluable for studying unusual events (which



**Fig. 10.3 Critical fluctuations.** The two-dimensional square-lattice Ising model near the critical temperature  $T_c$ . Here the ‘islands’ come in all sizes, and the equilibrium fluctuations happen on all time scales; see Chapter 12.

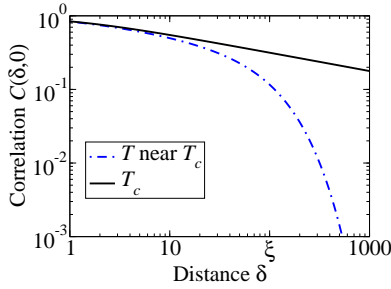


**Fig. 10.4 Equal-time correlation function.** A schematic equal-time correlation function  $C(r, \tau = 0)$  at a temperature just above and just below the critical temperature  $T_c$ . At  $r = 0$  the correlation function is  $\langle S^2 \rangle = 1$ . (The distance  $\xi(T)$  after which the correlation function decays exponentially to its long-distance value (zero or  $m^2$ ) is the *correlation length*. At  $T_c$  the correlation length diverges, leading to fluctuations on all scales, Chapter 12).

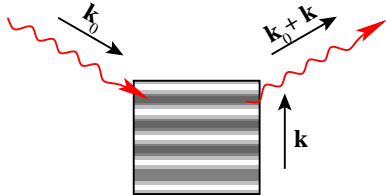
<sup>4</sup>Here  $\rho(\mathbf{x}, t) = \sum_j \delta(\mathbf{x} - \mathbf{x}_j)$  measures the positions of the atoms.

<sup>5</sup>Medical X-rays and CAT scans measure the penetration of X-rays, not their diffraction.

<sup>6</sup>Since the electrons are mostly tied to atomic nuclei,  $C_{ee}(\mathbf{r})$  is writable in terms of atom–atom correlation functions (Exercise 10.2). This is done using *form factors* [9, chapter 6].



**Fig. 10.5 Power-law correlations.** The schematic correlation function of figure 10.4 on a log-log plot, both at  $T_c$  (straight line, representing the power law  $C \sim r^{-(d-2+\eta)}$ ) and above  $T_c$  (where the dependence shifts to  $C \sim e^{-r/\xi(T)}$ ) at distances beyond the correlation length  $\xi(T)$ ). See Chapter 12.



**Fig. 10.6 X-ray scattering.** A beam of wavevector  $\mathbf{k}_0$  scatters off a density variation  $\rho(\mathbf{x})$  with wavevector  $\mathbf{k}$  to a final wavevector  $\mathbf{k}_0 + \mathbf{k}$ ; the intensity of the scattered beam is proportional to  $|\tilde{\rho}(\mathbf{k})|^2$  [9, chapter 6].

<sup>7</sup> $\delta\mathcal{F}/\delta\rho$  is a *variational derivative*.  $\mathcal{F}$  is a mapping taking functions to other functions; under a small change  $\delta\rho$  in its argument,  $\mathcal{F}\{\rho + \delta\rho\} - \mathcal{F}\{\rho\} = \int(\delta\mathcal{F}/\delta\rho)\delta\rho d\mathbf{x}$ . The integral can be viewed as a kind of dot product of  $\delta\rho$  with  $\delta\mathcal{F}/\delta\rho$  (see Section A.3 for inner products in function space), so the variational derivative is just like a gradient of a function, where  $f(\mathbf{x} + \delta) = \nabla f \cdot \delta$ .

would be swamped in a bulk average), distributions of local geometries (individual ensemble elements rather than averages over the ensemble), and physical dynamical mechanisms. The  $k$ -space methods, on the other hand, by averaging over the entire sample, can provide great precision, and have close ties with calculational and analytical methods (as presented in this chapter). Indeed, often one will computationally Fourier transform measured real-space data in order to generate correlation functions (Exercise 10.1).

### 10.3 Equal-time correlations in the ideal gas

For the rest of this chapter we will consider systems which are in equilibrium and close to equilibrium. In these cases, we shall be able to find surprisingly tight relations between the correlations, response, and dissipation. We focus on the ideal gas, which is both the simplest and the most difficult case. In the exercises, you can calculate correlation functions that are algebraically more challenging (Exercise 10.8) but the ideal gas case is both conceptually subtle and fundamental. Let us start by calculating the equal-time correlation function  $C^{\text{ideal}}(\mathbf{r}, 0)$ .

The Helmholtz free energy density of the ideal gas is

$$\mathcal{F}^{\text{ideal}}(\rho(\mathbf{x}), T) = \rho(\mathbf{x})k_B T [\log(\rho(\mathbf{x})\lambda^3) - 1] \quad (10.5)$$

(eqn 6.62). The probability  $P\{\rho(\mathbf{x})\}$  of finding a particular density profile  $\rho(\mathbf{x})$  as a fluctuation is proportional to

$$P\{\rho(\mathbf{x})\} \propto e^{-\beta \int \mathcal{F}(\rho(\mathbf{x})) d\mathbf{x}}. \quad (10.6)$$

Let us assume the fluctuations are small, and expand about  $\langle\rho\rangle = \rho_0$ :

$$\begin{aligned} \mathcal{F}(\rho(\mathbf{x})) &= \mathcal{F}_0 + \left. \frac{\delta\mathcal{F}}{\delta\rho} \right|_{\rho_0} (\rho - \rho_0) + \frac{1}{2} \left. \frac{\delta^2\mathcal{F}}{\delta\rho^2} \right|_{\rho_0} (\rho - \rho_0)^2 \\ &= \mathcal{F}_0 + \mu_0(\rho - \rho_0) + \frac{1}{2}\alpha(\rho - \rho_0)^2, \end{aligned} \quad (10.7)$$

where <sup>7</sup> $\mu_0 = (\delta\mathcal{F}/\delta\rho)|_{\rho_0}$  is the chemical potential and the coefficient of the quadratic term is

$$\alpha = \left. \frac{\partial^2\mathcal{F}}{\partial\rho^2} \right|_{\rho_0} = k_B T / \rho_0 = P_0 / \rho_0^2 \quad (10.8)$$

(since the pressure  $P_0 = Nk_B T / V = \rho_0 k_B T$ ). Only the integral of the free energy matters, so

$$\int \mathcal{F}(\rho(\mathbf{x})) d\mathbf{x} = V\mathcal{F}_0 + \mu_0 \int (\rho - \rho_0) d\mathbf{x} + \int \frac{1}{2}\alpha(\rho - \rho_0)^2 d\mathbf{x}, \quad (10.9)$$

where  $\mu_0$  drops out because the average of  $\rho$  equals  $\rho_0$ . We can also drop  $\mathcal{F}_0$  because it changes the free energy of all configurations by a constant,

and does not change their relative probabilities.<sup>8</sup> So the effective free energy of the ideal gas, for small density fluctuations, is

$$\mathcal{F}(\rho) = \frac{1}{2}\alpha(\rho - \rho_0)^2, \quad (10.10)$$

and the probability of finding a density fluctuation is

$$P\{\rho(\mathbf{x})\} \propto e^{-\beta \int \frac{1}{2}\alpha(\rho - \rho_0)^2 d\mathbf{x}}. \quad (10.11)$$

We can now calculate the expectation value of the equal-time density-density correlation function:

$$C^{\text{ideal}}(\mathbf{r}, 0) = \langle \rho(\mathbf{x}, t)\rho(\mathbf{x} + \mathbf{r}, t) \rangle - \rho_0^2 = \langle (\rho(\mathbf{x}, t) - \rho_0)(\rho(\mathbf{x} + \mathbf{r}, t) - \rho_0) \rangle. \quad (10.12)$$

Here we subtract off the square of the average density, so that we measure the correlations between the fluctuations of the order parameter about its mean value. (Subtracting the means gives us the *connected* correlation function.) If we break up the ideal gas into tiny boxes of size  $\Delta V$ , the probability of having density  $\rho(\mathbf{x}_j)$  in volume  $j$  is

$$P_j(\rho) \propto \exp\left(-\frac{\frac{1}{2}\alpha(\rho - \rho_0)^2\Delta V}{k_B T}\right) = \exp\left(-\frac{(\rho - \rho_0)^2}{2/(\beta\alpha\Delta V)}\right). \quad (10.13)$$

This is a Gaussian of root-mean-square width  $\sigma = \sqrt{1/(\beta\alpha\Delta V)}$ , so the mean square fluctuations inside a single box is

$$\langle (\rho - \rho_0)^2 \rangle = \frac{1}{\beta\alpha\Delta V}. \quad (10.14)$$

The density fluctuations in different boxes are uncorrelated. This means  $C^{\text{ideal}}(\mathbf{r}, 0) = 0$  for  $\mathbf{r}$  reaching between two boxes, and  $C^{\text{ideal}}(\mathbf{0}, 0) = 1/(\beta\alpha\Delta V)$  within one box.<sup>9</sup>

What does it mean for  $C^{\text{ideal}}$  to depend on the box size  $\Delta V$ ? The fluctuations become stronger as the box gets smaller. We are familiar with this; we saw earlier using the microcanonical ensemble (Section 3.2.1 and eqn 3.67) that the square of the number fluctuations in a small subvolume of ideal gas was equal to the expected number of particles  $\langle (N - \langle N \rangle)^2 \rangle = N$ ,<sup>10</sup> so the fractional fluctuations  $1/\sqrt{N}$  get larger as the volume gets smaller.

How do we write the correlation function, though, in the limit  $\Delta V \rightarrow 0$ ? It must be infinite at  $\mathbf{r} = \mathbf{0}$ , and zero for all non-zero  $\mathbf{r}$ . More precisely, it is proportional the Dirac  $\delta$ -function, this time in three dimensions  $\boldsymbol{\delta}(\mathbf{r}) = \delta(r_x)\delta(r_y)\delta(r_z)$ . The equal-time connected correlation function for the ideal gas is

$$C^{\text{ideal}}(\mathbf{r}, 0) = \frac{1}{\beta\alpha}\boldsymbol{\delta}(\mathbf{r}). \quad (10.16)$$

*The correlation function of an uncorrelated system is white noise.*<sup>11</sup>

<sup>8</sup>Each Boltzmann factor shifts by  $e^{-\beta V \mathcal{F}_0}$ , so  $Z$  shifts by the same factor, and so the ratio  $e^{-\beta V \mathcal{F}_0}/Z$  giving the probability is independent of  $\mathcal{F}_0$ .

<sup>9</sup>Thus the correlation length  $\xi$  for the ideal gas is zero (Fig. 10.4).

<sup>10</sup>Do the two calculations agree? Using eqn 10.8 and the ideal gas law  $P_0 V = N k_B T = N/\beta$ , the density fluctuations

$$\begin{aligned} \langle (\rho - \rho_0)^2 \rangle &= \frac{(N - \langle N \rangle)^2}{(\Delta V)^2} \\ &= \frac{N}{(\Delta V)^2} = \frac{\rho_0}{\Delta V} \\ &= \frac{1}{(\rho_0/P_0)(P_0/\rho_0^2)\Delta V} \\ &= \frac{1}{(N/P_0 V)\alpha\Delta V} \\ &= \frac{1}{\beta\alpha\Delta V} \end{aligned} \quad (10.15)$$

are just as we computed from  $\mathcal{F}^{\text{ideal}}$ .

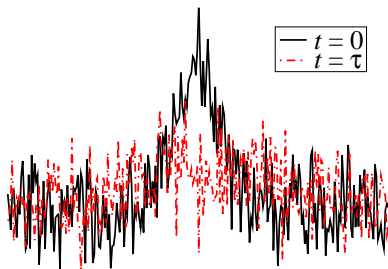
<sup>11</sup>White light is a mixture of all frequencies of light with equal amplitude and random phases (Exercise A.8). Our noise has the same property. The Fourier transform of  $C(\mathbf{r}, 0)$ ,  $\tilde{C}(\mathbf{k}, t = 0) = (1/V)|\tilde{\rho}(k)|^2$  (as in eqn 10.4), is constant, independent of the wavevector  $k$ . Hence all modes have equal weight. To show that the phases are random, we can express the free energy (eqn 10.9) in Fourier space, where it is a sum over uncoupled harmonic modes; hence in equilibrium they have random relative phases (see Exercise 10.8).

We can see that the constant outside is indeed  $1/\beta\alpha$ , by using  $C^{\text{ideal}}$  to calculate the mean square fluctuations of the integral of  $\rho$  inside the box of volume  $\Delta V$ :

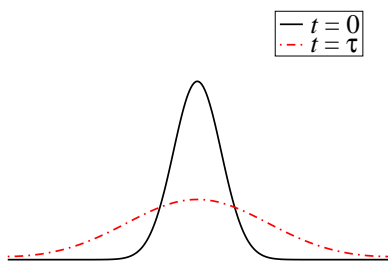
$$\begin{aligned} \langle(\rho - \rho_0)^2\rangle_{\text{box}} &= \left\langle \left( \frac{1}{\Delta V} \int_{\Delta V} (\rho(\mathbf{x}) - \rho_0) \, d\mathbf{x} \right)^2 \right\rangle \\ &= \frac{1}{(\Delta V)^2} \int_{\Delta V} d\mathbf{x} \int_{\Delta V} d\mathbf{x}' \langle (\rho(\mathbf{x}) - \rho_0)(\rho(\mathbf{x}') - \rho_0) \rangle \\ &= \frac{1}{(\Delta V)^2} \int_{\Delta V} d\mathbf{x} \int_{\Delta V} d\mathbf{x}' \frac{1}{\beta\alpha} \delta(\mathbf{x} - \mathbf{x}') \\ &= \frac{1}{\beta\alpha(\Delta V)^2} \int_{\Delta V} d\mathbf{x} = \frac{1}{\beta\alpha \Delta V}, \end{aligned} \quad (10.17)$$

in agreement with our earlier calculation (eqn 10.14).

## 10.4 Onsager's regression hypothesis and time correlations



**Fig. 10.7 Noisy decay of a fluctuation.** An unusual fluctuation at  $t = 0$  will slowly decay to a more typical thermal configuration at a later time  $\tau$ .



**Fig. 10.8 Deterministic decay of an initial state.** An initial condition with the same density will slowly decay to zero.

Equilibrium statistical mechanics does not determine the dynamics. Air and perfume are both good ideal gases, but density fluctuations in air lead to sound waves, while they lead to diffusion in perfume (which scatters off the air molecules). We need to supplement statistical mechanics with more information in order to calculate time correlations. There are two basic choices. We could work with the microscopic laws; indeed, most treatments of this topic start from quantum mechanics [43]. Instead, here we will rely on the *macroscopic* evolution laws to specify our dynamics.

How are the density fluctuations in an ideal gas of perfume correlated in time? In particular, suppose at  $t = 0$  there is a rare fluctuation, increasing the density of perfume at one point (Fig. 10.7). How will it decay to a more typical density profile as time passes?

Macroscopically our perfume obeys the diffusion equation of Chapter 2. There we derived the evolution laws for imposed initial non-equilibrium density profiles, and ignored the spontaneous thermal fluctuations. A macro-scale initial condition (Fig. 10.8) will evolve according to the diffusion equation  $\partial\rho/\partial t = D\nabla^2\rho$ . The confusing point about the microscopic density (Fig. 10.7) is that it introduces new spontaneous thermal fluctuations while it flattens old ones.

In this text, we have been rather casual in denoting averages, using the same symbol  $\langle \cdot \rangle$  for time averages, spatial averages, and averages over microcanonical, canonical, and grand canonical ensembles. In this section we will be doing several different kinds of averages, and we need to distinguish between them. Our microcanonical, canonical, and grand canonical ensemble averages cannot be used to calculate quantities depending on more than one time (because the equilibrium ensembles are independent of dynamics). Let us write  $\langle \cdot \rangle_{\text{eq}}$  for these equal-time equilibrium averages. The time-time correlation functions are defined by an



equilibrium ensemble of time evolutions, which may include noise from the environment. Let us denote these averages by  $\langle \cdot \rangle_{\text{ev}}$ . Thus  $\langle \cdot \rangle_{\text{ev}}$  generalizes  $\langle \cdot \rangle_{\text{eq}}$  to work on quantities that depend on more than one time. Finally, let us write  $[\cdot]_{\rho_i}$  for the noisy evolution average fixing the initial condition  $\rho(\mathbf{x}, 0) = \rho_i(\mathbf{x})$  at time zero. This averages over all the new spontaneous density fluctuations, allowing us to examine the decay of an initial spontaneous density fluctuation, or perhaps an initial imposed density profile.

We will assume that this last average fixing the initial condition obeys the same diffusion equation that governs the macroscopic time evolution (Figs 10.7 and 10.8). For our diffusion of perfume, this means

$$\frac{\partial}{\partial t} [\rho(\mathbf{x}, t)]_{\rho_i} = D\nabla^2 [\rho(\mathbf{x}, t)]_{\rho_i}. \quad (10.18)$$

This assumption is precisely Onsager's *regression hypothesis* [102],

... we may assume that a spontaneous deviation from the equilibrium decays according to the same laws as one that has been produced artificially.

Let us calculate the correlation function  $\langle \rho(\mathbf{r} + \mathbf{r}', t + t') \rho(\mathbf{r}', t') \rangle_{\text{ev}}$  by taking our evolution ensemble for fixed initial condition  $[\rho(\mathbf{x}, t)]_{\rho_i}$  and then taking a thermal average over initial conditions  $\rho(\mathbf{x}, 0) = \rho_i(\mathbf{x})$ . We may use the fact that our system is homogeneous and time independent to measure our correlation function starting at the origin:

$$\begin{aligned} C(\mathbf{r}, \tau) &= \langle (\rho(\mathbf{x} + \mathbf{r}, t + \tau) - \rho_0)(\rho(\mathbf{x}, t) - \rho_0) \rangle_{\text{ev}} \\ &= \langle (\rho(\mathbf{r}, \tau) - \rho_0)(\rho(\mathbf{0}, 0) - \rho_0) \rangle_{\text{ev}} \\ &= \left\langle ([\rho(\mathbf{r}, \tau)]_{\rho_i} - \rho_0)(\rho_i(\mathbf{0}) - \rho_0) \right\rangle_{\text{eq}}. \end{aligned} \quad (10.19)$$

In words, averaging over both initial conditions and noise  $\langle \cdot \rangle_{\text{ev}}$  is the same as first averaging over noise  $[\cdot]_{\rho_i}$  and then over initial conditions  $\langle \cdot \rangle_{\text{eq}}$ . We know from Onsager's regression hypothesis that

$$\begin{aligned} \frac{\partial C^{\text{ideal}}}{\partial t} &= \left\langle \frac{\partial}{\partial t} [\rho(\mathbf{r}, t)]_{\rho_i} (\rho_i(\mathbf{0}) - \rho_0) \right\rangle_{\text{eq}} \\ &= \left\langle D\nabla^2 [\rho(\mathbf{r}, t)]_{\rho_i} (\rho_i(\mathbf{0}) - \rho_0) \right\rangle_{\text{eq}} \\ &= D\nabla^2 \left\langle [\rho(\mathbf{r}, t)]_{\rho_i} (\rho_i(\mathbf{0}) - \rho_0) \right\rangle_{\text{eq}} \\ &= D\nabla^2 \langle (\rho(\mathbf{r}, t) - \rho_0)(\rho(\mathbf{0}, 0) - \rho_0) \rangle_{\text{ev}} \\ &= D\nabla^2 C^{\text{ideal}}(\mathbf{r}, t). \end{aligned} \quad (10.20)$$

The correlation function  $C$  obeys the same equation as the decays of imposed initial conditions. This is true in general.<sup>12</sup>

Thus to solve in a general system for the correlation function  $C$ , we must calculate as the initial condition the instantaneous correlations  $C(\mathbf{x}, 0)$  using equilibrium statistical mechanics, and evolve it according

<sup>12</sup>We can use Onsager's regression hypothesis to calculate the correlation function  $C$  for a general order parameter  $s(\mathbf{x}, t)$ . Suppose that the macroscopic time evolution of  $s(\mathbf{x}, t)$ , to linear order in deviations away from its average value  $\bar{s}$ , is given by some Green's function (Section 2.4.2):

$$\begin{aligned} s_{\text{macro}}(\mathbf{x}, t) &= \bar{s} - \int d\mathbf{x}' G(\mathbf{x} - \mathbf{x}', t) \\ &\quad \times (s_{\text{macro}}(\mathbf{x}', 0) - \bar{s}). \end{aligned} \quad (10.21)$$

For convenience, let us set  $\bar{s} = 0$ . This convolution simplifies if we Fourier transform in position  $\mathbf{x}$  but not in time  $t$ , using the convolution theorem for Fourier transforms (eqn A.23):

$$\hat{s}_{\text{macro}}(\mathbf{k}, t) = \hat{G}(\mathbf{k}, t) \hat{s}(\mathbf{k}, 0), \quad (10.22)$$

where we use a hat to denote the Fourier transform confined to position space. Onsager's regression hypothesis says that a spontaneous initial thermal fluctuation  $s_i$  will evolve according to the same law,

$$\begin{aligned} [\hat{s}(\mathbf{k}, t)]_{\hat{s}_i} &= \hat{G}(\mathbf{k}, t) \hat{s}_i(\mathbf{k}) \\ &= \hat{G}(\mathbf{k}, t) \hat{s}(\mathbf{k}, t = 0), \end{aligned} \quad (10.23)$$

so the connected correlation function

$$\begin{aligned} C(\mathbf{r}, t) &= \langle s(\mathbf{r}, t) s(\mathbf{0}, 0) \rangle_{\text{ev}} \\ &= \langle [s(\mathbf{r}, t)]_{s_i} s_i(\mathbf{0}) \rangle_{\text{eq}} \end{aligned} \quad (10.24)$$

evolves by

$$\begin{aligned} \hat{C}(\mathbf{k}, t) &= \langle [\hat{s}(\mathbf{k}, t)]_{s_i} s_i(\mathbf{0}) \rangle_{\text{eq}} \\ &= \langle \hat{G}(\mathbf{k}, t) \hat{s}(\mathbf{k}, 0) s_i(\mathbf{0}) \rangle_{\text{eq}} \\ &= \hat{G}(\mathbf{k}, t) \hat{C}(\mathbf{k}, 0). \end{aligned} \quad (10.25)$$

Again, the correlation function obeys the same evolution law as the decay of an imposed initial condition.

<sup>13</sup>Notice that Onsager's regression hypothesis allows us to evolve  $C(\tau)$  forward in time using the Green's function. For negative times, we note that for a time-translation-invariant system  $C(\tau) \sim \langle \rho(t + \tau)\rho(t) \rangle = \langle \rho(t')\rho(t' - \tau) \rangle = C(-\tau)$ , hence the absolute value of  $\tau$  in eqn 10.26. In linear response theory, this can be handled formally by introducing *retarded and advanced Green's functions*.

to the macroscopic evolution law. In the case of the ideal perfume gas, the equal-time correlations (eqn 10.16) are  $C^{\text{ideal}}(\mathbf{r}, 0) = 1/(\beta\alpha)\delta(\mathbf{r})$ , and the evolution law is given by the diffusion equation. We know how an initial  $\delta$ -function distribution evolves under the diffusion equation:<sup>13</sup> it is given by the Green's function (Section 2.4.2). The Green's function for the diffusion equation in one dimension (eqn 2.32) is  $G(x, t) = (1/\sqrt{4\pi Dt})e^{-x^2/4Dt}$ . In three dimensions we take the product along  $x$ ,  $y$ , and  $z$  to get  $G$ , and then divide by  $\beta\alpha$ , to get the correlation function

$$C^{\text{ideal}}(\mathbf{r}, \tau) = \frac{1}{\beta\alpha}G(\mathbf{r}, \tau) = \frac{1}{\beta\alpha} \left( \frac{1}{\sqrt{4\pi D\tau}} \right)^3 e^{-\mathbf{r}^2/4D|\tau|}. \quad (10.26)$$

This is the correlation function for an ideal gas satisfying the diffusion equation.

## 10.5 Susceptibility and linear response

How will our system yield when we kick it? The *susceptibility*  $\chi(\mathbf{r}, \tau)$  gives the response at a distance  $\mathbf{r}$  and time  $\tau$  from a (gentle) kick. Let us formulate susceptibility for a general order parameter  $s(\mathbf{x}, t)$ , kicked by an external field  $f(\mathbf{x}, t)$ . That is, we assume that  $f$  appears in the free energy functional

$$F = F_0 + F_f \quad (10.27)$$

as a term

$$F_f(t) = - \int d\mathbf{x} f(\mathbf{x}, t)s(\mathbf{x}, t). \quad (10.28)$$

You can think of  $f$  as a force density pulling  $s$  upward. If  $s$  is the particle density  $\rho$ , then  $f$  is minus an external potential  $-V(\mathbf{x})$  for the particles; if  $s$  is the magnetization  $M$  of an Ising model, then  $f$  is the external field  $H$ ; if  $s$  is the polarization  $\mathbf{P}$  of a dielectric material, then  $f$  is an externally applied vector electric field  $\mathbf{E}(\mathbf{x}, t)$ . For convenience, we will assume in this section that  $\bar{s} = 0$ .<sup>14</sup>

How will the order parameter field  $s$  respond to the force  $f$ ? If the force is a weak perturbation, we can presume a linear response, but perhaps one which is non-local in space and time. So,  $s(\mathbf{x}, t)$  will depend upon  $f(\mathbf{x}', t')$  at all earlier times  $t' < t$ :

$$s(\mathbf{x}, t) = \int d\mathbf{x}' \int_{-\infty}^t dt' \chi(\mathbf{x} - \mathbf{x}', t - t')f(\mathbf{x}', t'). \quad (10.29)$$

This non-local relation becomes much simpler if we Fourier transform<sup>15</sup>  $s$ ,  $f$ , and  $\chi$  in space and time. The AC susceptibility<sup>16</sup>  $\tilde{\chi}(\mathbf{k}, \omega)$  satisfies

$$\tilde{s}(\mathbf{k}, \omega) = \tilde{\chi}(\mathbf{k}, \omega)\tilde{f}(\mathbf{k}, \omega), \quad (10.30)$$

since as usual the Fourier transform of the convolution is the product of the Fourier transforms (eqn A.23). The function  $\chi$  is the *susceptibility* of the order parameter  $s$  to the external field  $f$ . For example, the polarization versus field is defined in terms of the polarizability  $\alpha$ :<sup>17</sup>  $\tilde{\mathbf{P}}(\mathbf{k}, \omega) = \tilde{\alpha}(\mathbf{k}, \omega)\tilde{\mathbf{E}}(\mathbf{k}, \omega)$ , the magnetization from an external field is  $\tilde{\mathbf{M}}(\mathbf{k}, \omega) = \tilde{\chi}(\mathbf{k}, \omega)\tilde{\mathbf{H}}(\mathbf{k}, \omega)$ , and so on.

<sup>14</sup>Or rather, we can define  $s$  to be the deviation from the average value of the order parameter in the absence of a field.

<sup>15</sup>We will use a tilde  $\tilde{A}(\mathbf{k}, \omega)$  to represent the Fourier transform of the function  $A(\mathbf{x}, t)$  with respect to both space and time. We will also use a tilde  $\tilde{B}(\mathbf{k})$  to represent the Fourier transform of the static function  $B(\mathbf{x})$  with respect to space. But we will use a hat  $\hat{A}(\mathbf{k}, t)$  to represent the Fourier transform of  $A(\mathbf{x}, t)$  in space  $\mathbf{x}$  alone.

<sup>16</sup>AC stands for 'alternating current', the kind of electricity that is used in most buildings; the voltage fluctuates periodically in time. The current from batteries is DC or direct current, which does not vary in time. Somehow we have started using AC for all frequency-dependent systems.

<sup>17</sup>In electromagnetism, one usually uses the dielectric permittivity  $\epsilon$  rather than the polarizability  $\alpha$ . In SI/MKSA units,  $\alpha = \epsilon - \epsilon_0$ , subtracting off the 'permittivity of the vacuum'  $\epsilon_0$ ; the dielectric constant is  $\epsilon/\epsilon_0$ . In Gaussian CGS units,  $\alpha = (\epsilon - 1)/4\pi$ , (and the dielectric constant is also  $\epsilon$ ). Note also  $\alpha$  and  $\epsilon$  are tensors (matrices) in anisotropic materials, and  $\mathbf{P}$  need not be parallel to  $\mathbf{E}$ .

## 10.6 Dissipation and the imaginary part

The real-space susceptibility  $\chi(\mathbf{x}, t)$  is real, but the AC susceptibility

$$\tilde{\chi}(\mathbf{k}, \omega) = \int d\mathbf{x} dt e^{i\omega t} e^{-i\mathbf{k}\cdot\mathbf{x}} \chi(\mathbf{x}, t) = \chi'(\mathbf{k}, \omega) + i\chi''(\mathbf{k}, \omega) \quad (10.31)$$

has a real part  $\chi' = \text{Re}[\tilde{\chi}]$  and an imaginary part  $\chi'' = \text{Im}[\tilde{\chi}]$ .<sup>18</sup> It is clear from the definition that  $\tilde{\chi}(-\mathbf{k}, -\omega) = \tilde{\chi}^*(\mathbf{k}, \omega)$ ; for a system with inversion symmetry  $\mathbf{x} \leftrightarrow -\mathbf{x}$  we see further that  $\chi(\mathbf{x}, t) = \chi(-\mathbf{x}, t)$  and hence  $\tilde{\chi}(\mathbf{k}, -\omega) = \tilde{\chi}^*(\mathbf{k}, \omega)$ , so  $\chi'$  is even in  $\omega$  and  $\chi''$  is odd.  $\chi'$  gives the in-phase response to a sinusoidal force, and  $\chi''$  gives the response that lags in phase.<sup>19</sup>

The imaginary part  $\chi''$  in general gives the amount of *dissipation* induced by the external field.<sup>20</sup> The dissipation can be measured directly (for example, by measuring the resistance as a function of frequency of a wire) or by looking at the decay of waves in the medium (optical and ultrasonic attenuation and such). We know that ‘energy’ is the integral of ‘force’  $f$  times ‘distance’  $\partial s$ , or force times velocity  $\partial s/\partial t$  integrated over time. Ignoring the spatial dependence for simplicity, the time average of the power  $p$  dissipated per unit volume is

$$p = \lim_{T \rightarrow \infty} \frac{1}{T} \int_0^T f(t) \frac{\partial s}{\partial t} dt = \lim_{T \rightarrow \infty} \frac{1}{T} \int_0^T -s(t) \frac{\partial f}{\partial t} dt, \quad (10.33)$$

where we have averaged over a time  $T$  and integrated by parts, assuming the boundary terms are negligible for  $T \rightarrow \infty$ . Assuming an AC force  $f(t) = \text{Re}[f_\omega e^{-i\omega t}] = \frac{1}{2}(f_\omega e^{-i\omega t} + f_\omega^* e^{i\omega t})$ , we have

$$p(\omega) = \lim_{T \rightarrow \infty} \frac{1}{T} \int_0^T s(t) \frac{i\omega}{2} (f_\omega e^{-i\omega t} - f_\omega^* e^{i\omega t}) dt, \quad (10.34)$$

where the motion  $s(t)$  is in turn due to the forcing at earlier times:

$$\begin{aligned} s(t) &= \int_{-\infty}^{\infty} dt' \chi(t-t') f(t') \\ &= \int_{-\infty}^{\infty} d\tau \chi(\tau) f(t-\tau) \\ &= \int_{-\infty}^{\infty} d\tau \frac{\chi(\tau)}{2} (f_\omega e^{-i\omega(t-\tau)} + f_\omega^* e^{i\omega(t-\tau)}). \end{aligned} \quad (10.35)$$

Substituting eqn 10.35 into eqn 10.34, we get

$$\begin{aligned} p(\omega) &= \lim_{T \rightarrow \infty} \frac{1}{T} \int_0^T dt \int_{-\infty}^{\infty} d\tau \frac{i\omega \chi(\tau)}{4} \\ &\quad \times (f_\omega e^{-i\omega(t-\tau)} + f_\omega^* e^{i\omega(t-\tau)}) (f_\omega e^{-i\omega t} - f_\omega^* e^{i\omega t}) \\ &= \int_{-\infty}^{\infty} d\tau \frac{i\omega \chi(\tau)}{4} \lim_{T \rightarrow \infty} \frac{1}{T} \int_0^T dt \\ &\quad \times [f_\omega^2 e^{-i\omega(2t-\tau)} - f_\omega^{*2} e^{i\omega(2t-\tau)} + |f_\omega|^2 (e^{-i\omega\tau} - e^{i\omega\tau})]. \end{aligned} \quad (10.36)$$

<sup>18</sup>Some use the complex conjugate of our formulae for the Fourier transform (see Section A.1), substituting  $-i$  for  $i$  in the time Fourier transforms. Their  $\chi''$  is the same as ours, because they define it to be *minus* the imaginary part of their Fourier-transformed susceptibility.

<sup>19</sup>If we apply  $f(t) = \cos(\omega_0 t) = 1/2\pi \int \tilde{f}(\omega) \exp(-i\omega t) dt$  (eqn A.7), so  $\tilde{f}(\omega) = \pi(\delta(\omega - \omega_0) + \delta(\omega + \omega_0))$ , then the response is  $\tilde{s}(\omega) = \tilde{\chi}(\omega) \tilde{f}(\omega)$ , so

$$\begin{aligned} s(t) &= \frac{1}{2\pi} \int e^{-i\omega t} \tilde{s}(\omega) d\omega \\ &= \frac{1}{2} (e^{-i\omega_0 t} \chi(\omega_0) + e^{i\omega_0 t} \chi(-\omega_0)) \\ &= \frac{1}{2} (e^{-i\omega_0 t} (\chi'(\omega_0) + i\chi''(\omega_0)) \\ &\quad + e^{i\omega_0 t} (\chi'(\omega_0) - i\chi''(\omega_0))) \\ &= (\chi'(\omega_0) \cos(\omega_0 t) \\ &\quad + \chi''(\omega_0) \sin(\omega_0 t)). \end{aligned} \quad (10.32)$$

Hence  $\chi'$  gives the immediate in-phase response, and  $\chi''$  gives the out-of-phase delayed response.

<sup>20</sup>The real part is sometimes called the *reactive* response, whereas the imaginary part is the *dissipative* response.

<sup>21</sup>In particular,

$$i(e^{-i\omega\tau} - e^{i\omega\tau}) = 2\sin(\omega\tau),$$

$$\lim_{T \rightarrow \infty} (1/T) \int_0^T dt e^{\pm 2i\omega t} = 0, \text{ and}$$

$$\lim_{T \rightarrow \infty} (1/T) \int_0^T dt e^{0i\omega t} = 1.$$

The first and second terms are zero, and the third gives a sine,<sup>21</sup> so

$$\begin{aligned} p(\omega) &= \frac{\omega|f_\omega|^2}{2} \int_{-\infty}^{\infty} d\tau \chi(\tau) \sin(\omega\tau) = \frac{\omega|f_\omega|^2}{2} \text{Im}[\tilde{\chi}(\omega)] \\ &= \frac{\omega|f_\omega|^2}{2} \chi''(\omega). \end{aligned} \quad (10.37)$$

<sup>22</sup>We knew already (beginning of this section) that  $\chi''$  was odd; now we know also that it is positive for  $\omega > 0$ .

Since the power dissipated must be positive, we find  $\omega\chi''(\omega)$  is positive.<sup>22</sup>

Let us interpret this formula in the familiar case of electrical power dissipation in a wire. Under a (reasonably low-frequency) AC voltage  $V(t) = V_\omega \cos(\omega t)$ , a wire of resistance  $R$  dissipates average power  $\langle P \rangle = \langle V^2/R \rangle = V_\omega^2 \langle \cos^2(\omega t) \rangle / R = \frac{1}{2} V_\omega^2 / R$  by Ohm's law. A wire of length  $L$  and cross-section  $A$  has electric field  $E_\omega \cos \omega t$  with  $E_\omega = V_\omega/L$ , and it has resistance  $R = L/(\sigma A)$ , where  $\sigma$  is the conductivity of the metal. So the average dissipated power per unit volume  $p(\omega) = \langle P \rangle / (LA) = \frac{1}{2} ((E_\omega L)^2 / (L/\sigma A)) (1/LA) = \frac{1}{2} \sigma E_\omega^2$ . Remembering that  $E_\omega$  is the force  $f_\omega$  and the polarizability  $\alpha(\omega)$  is the susceptibility  $\chi(\omega)$ , eqn 10.37 tells us that the DC conductivity is related to the limit of the AC polarizability at zero frequency:  $\sigma = \lim_{\omega \rightarrow 0} \omega \alpha''(\omega)$ .

## 10.7 Static susceptibility

In many cases, we are interested in how a system responds to a static external force—rather than kicking a system, we lean on it. Under a point-like force, the dimple formed in the order parameter field is described by the *static susceptibility*  $\chi_0(\mathbf{r})$ .

If the external force is time independent (so  $f(\mathbf{x}', t') = f(\mathbf{x}')$ ) the system will reach a perturbed equilibrium, and we may use equilibrium statistical mechanics to find the resulting static change in the average order parameter field  $s(\mathbf{x})$ . The non-local relation between  $s$  and a small field  $f$  is given by the *static susceptibility*,  $\chi_0$ :

$$s(\mathbf{x}) = \int d\mathbf{x}' \chi_0(\mathbf{x} - \mathbf{x}') f(\mathbf{x}'). \quad (10.38)$$

If we take the Fourier series of  $s$  and  $f$ , we may represent this relation in terms of the Fourier transform of  $\chi_0$  (eqn A.23):

$$\tilde{s}_{\mathbf{k}} = \tilde{\chi}_0(\mathbf{k}) \tilde{f}_{\mathbf{k}}. \quad (10.39)$$

As an example,<sup>23</sup> the free energy density for the ideal gas, in the linearized approximation of Section 10.3, is  $\mathcal{F} = \frac{1}{2}\alpha(\rho - \rho_0)^2$ . For a spatially-varying static external potential  $f(\mathbf{x}) = -V(\mathbf{x})$ , this is minimized by  $\rho(\mathbf{x}) = \rho_0 + f(\mathbf{x})/\alpha$ , so (comparing with eqn 10.38) we find the static susceptibility is

$$\chi_0^{\text{ideal}}(\mathbf{r}) = \delta(\mathbf{r})/\alpha, \quad (10.43)$$

and in Fourier space it is  $\tilde{\chi}_0(\mathbf{k}) = 1/\alpha$ . Here  $\chi_0$  is the ‘spring constant’ giving the response to a constant external force.

Notice for the ideal gas that the static susceptibility  $\chi_0^{\text{ideal}}(\mathbf{r})$  and the equal-time correlation function  $C^{\text{ideal}}(\mathbf{r}, 0) = \delta(\mathbf{r})/(\beta\alpha)$  are proportional to one another:  $\chi_0^{\text{ideal}}(\mathbf{r}) = \beta C^{\text{ideal}}(\mathbf{r}, 0)$ . This can be shown to be true in general for equilibrium systems (note 23):

$$\chi_0(\mathbf{r}) = \beta C(\mathbf{r}, 0). \quad (10.44)$$

That is, the  $\omega = 0$  static susceptibility  $\chi_0$  is given by dividing the instantaneous correlation function  $C$  by  $k_B T$ —both in real space and also in Fourier space:

$$\tilde{\chi}_0(\mathbf{k}) = \beta \hat{C}(\mathbf{k}, 0). \quad (10.45)$$

This *fluctuation-response* relation should be intuitively reasonable; a system or mode which is easy to perturb will also have big fluctuations.

<sup>23</sup>We can derive eqn 10.45 in general, by a (somewhat abstract) calculation. We find the expectation value  $\langle \tilde{s}_{\mathbf{k}} \rangle_{\text{eq}}$  for a given  $\tilde{f}_{\mathbf{k}}$ , and then take the derivative with respect to  $\tilde{f}_{\mathbf{k}}$  to get  $\tilde{\chi}_0(\mathbf{k})$ . The interaction term in the free energy eqn 10.28 reduces in the case of a static force to

$$F_f = - \int d\mathbf{x} f(\mathbf{x}) s(\mathbf{x}) = -V \sum_{\mathbf{k}'} \tilde{f}_{\mathbf{k}'} \tilde{s}_{-\mathbf{k}'}, \quad (10.40)$$

where  $V$  is the volume (periodic boundary conditions) and the sum over  $\mathbf{k}'$  is the sum over allowed wavevectors in the box (Appendix A). (We use Fourier series here instead of Fourier transforms because it makes the calculations more intuitive; we get factors of the volume rather than  $\delta$ -functions and infinities.) The expectation value of the order parameter in the field is

$$\langle \tilde{s}_{\mathbf{k}} \rangle_{\text{eq}} = \text{Tr} \left[ \tilde{s}_{\mathbf{k}} e^{-\beta(F_0 - V \sum_{\mathbf{k}'} \tilde{f}_{\mathbf{k}'} \tilde{s}_{-\mathbf{k}'})} \right] / \text{Tr} \left[ e^{-\beta(F_0 - V \sum_{\mathbf{k}'} \tilde{f}_{\mathbf{k}'} \tilde{s}_{-\mathbf{k}'})} \right] = \frac{1}{\beta V} \frac{\partial \log Z}{\partial f_{-\mathbf{k}'}}, \quad (10.41)$$

where  $\text{Tr}$  integrates over all order parameter configurations  $s$  (formally a *path integral* over function space). The susceptibility is given by differentiating eqn 10.41:

$$\begin{aligned} \tilde{\chi}_0(\mathbf{k}) &= \left. \frac{\partial \langle \tilde{s}_{\mathbf{k}} \rangle_{\text{eq}}}{\partial \tilde{f}_{\mathbf{k}}} \right|_{f=0} \\ &= \frac{\text{Tr} \left[ \tilde{s}_{\mathbf{k}} (\beta V \tilde{s}_{-\mathbf{k}}) e^{-\beta(F_0 - V \sum_{\mathbf{k}'} \tilde{f}_{\mathbf{k}'} \tilde{s}_{-\mathbf{k}'})} \right]}{\text{Tr} \left[ e^{-\beta(F_0 - V \sum_{\mathbf{k}'} \tilde{f}_{\mathbf{k}'} \tilde{s}_{-\mathbf{k}'})} \right]} \bigg|_{f=0} - \frac{\text{Tr} \left[ \tilde{s}_{\mathbf{k}} e^{-\beta(F_0 - V \sum_{\mathbf{k}'} \tilde{f}_{\mathbf{k}'} \tilde{s}_{-\mathbf{k}'})} \right] \text{Tr} \left[ (\beta V \tilde{s}_{-\mathbf{k}}) e^{-\beta(F_0 - V \sum_{\mathbf{k}'} \tilde{f}_{\mathbf{k}'} \tilde{s}_{-\mathbf{k}'})} \right]}{\text{Tr} \left[ e^{-\beta(F_0 - V \sum_{\mathbf{k}'} \tilde{f}_{\mathbf{k}'} \tilde{s}_{-\mathbf{k}'})} \right]^2} \bigg|_{f=0} \\ &= \beta V (\langle \tilde{s}_{\mathbf{k}} \tilde{s}_{-\mathbf{k}} \rangle - \langle \tilde{s}_{\mathbf{k}} \rangle \langle \tilde{s}_{-\mathbf{k}} \rangle) = \beta V \langle (\tilde{s}_{\mathbf{k}} - \langle \tilde{s}_{\mathbf{k}} \rangle)^2 \rangle = \beta \hat{C}(\mathbf{k}, 0), \end{aligned} \quad (10.42)$$

where the last equation is the Fourier equality of the correlation function to the absolute square of the fluctuation (eqn A.21, except (i) because we are using Fourier series instead of Fourier transforms there are two extra factors of  $V$ , and (ii) the  $\langle s_{\mathbf{k}} \rangle$  subtraction gives us the connected correlation function, with  $\bar{s}$  subtracted off).

Note that everything again is calculated by taking derivatives of the partition function; in eqn 10.41  $\langle \tilde{s}_{\mathbf{k}} \rangle = (1/\beta) \partial \log Z / \partial f_{-\mathbf{k}}$  and in eqn 10.42  $\hat{C}(\mathbf{k}, 0) = (1/\beta^2) \partial^2 \log Z / \partial f_{\mathbf{k}} \partial f_{-\mathbf{k}}$ . The higher connected correlation functions can be obtained in turn by taking higher derivatives of  $\log Z$ . This is a common theoretical technique; to calculate correlations in an ensemble, add a force coupled to the corresponding field and take derivatives.

How is the static susceptibility  $\chi_0(\mathbf{r})$  related to our earlier dynamic susceptibility  $\chi(\mathbf{r}, t)$ ? We can use the dynamic susceptibility (eqn 10.29) in the special case of a time-independent force

$$\begin{aligned} s(\mathbf{x}, t) &= \int d\mathbf{x}' \int_{-\infty}^t dt' \chi(\mathbf{x} - \mathbf{x}', t - t') f(\mathbf{x}') \\ &= \int d\mathbf{x}' \int_0^{\infty} d\tau \chi(\mathbf{x} - \mathbf{x}', \tau) f(\mathbf{x}'), \end{aligned} \quad (10.46)$$

to derive a formula for  $\chi_0$ :

$$\chi_0(\mathbf{r}) = \int_0^{\infty} dt \chi(\mathbf{r}, t) = \int_{-\infty}^{\infty} dt \chi(\mathbf{r}, t). \quad (10.47)$$

Here we use the fact that the physical world obeys *causality* (effects cannot precede their cause) to set  $\chi(\mathbf{r}, t) = 0$  for  $t < 0$  (see Fig. 10.9). The integral over time in eqn 10.47 extracts the  $\omega = 0$  Fourier component, so the  $\mathbf{k}$ -dependent static susceptibility is the zero-frequency limit of the AC susceptibility:

$$\tilde{\chi}_0(\mathbf{k}) = \tilde{\chi}(\mathbf{k}, \omega = 0). \quad (10.48)$$

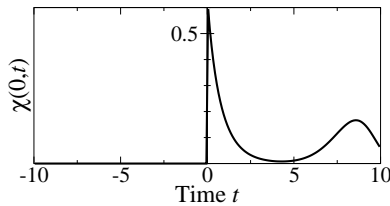
Often, one discusses the uniform susceptibility of a system—the response to an external field uniform not only in time but also in space. The specific heat of Section 6.1 is the uniform  $\mathbf{k} = \mathbf{0}$  value of the static susceptibility to a change in temperature, as the magnetic susceptibility of Exercise 8.1 is the susceptibility to a uniform change in field. For the uniform static susceptibility,  $s = \int d\mathbf{x}' \chi_0(\mathbf{x} - \mathbf{x}') f = \tilde{\chi}_0(\mathbf{k} = \mathbf{0}) f$ , so the uniform susceptibility is given by  $\tilde{\chi}_0(\mathbf{k})$  at  $\mathbf{k} = \mathbf{0}$ . Knowing  $\tilde{\chi}_0(\mathbf{k}) = \beta \hat{C}(\mathbf{k}, t = 0)$  (eqn 10.45), we can relate the uniform susceptibility to the  $\mathbf{k} = \mathbf{0}$  component of the equal-time correlation function. But at  $\mathbf{k} = \mathbf{0}$ , the correlation function is given by the mean square of the spatially-averaged order parameter  $\langle s \rangle_{\text{space}} = (1/V) \int s(\mathbf{x}) d\mathbf{x}$ :<sup>24</sup>

$$\begin{aligned} k_B T \tilde{\chi}_0(\mathbf{k} = \mathbf{0}) &= \hat{C}(\mathbf{k} = \mathbf{0}, t = 0) = \int d\mathbf{r} \langle s(\mathbf{r} + \mathbf{x}) s(\mathbf{x}) \rangle \\ &= \int d\mathbf{r} \frac{1}{V} \left\langle \int d\mathbf{x} s(\mathbf{r} + \mathbf{x}) s(\mathbf{x}) \right\rangle \\ &= V \left\langle \frac{1}{V} \int d\mathbf{r}' s(\mathbf{r}') \frac{1}{V} \int d\mathbf{x} s(\mathbf{x}) \right\rangle \\ &= V \langle \langle s \rangle_{\text{space}}^2 \rangle. \end{aligned} \quad (10.49)$$

We have thus connected a uniform linear response to the fluctuations of the whole system. We have done this in special cases twice before, in Exercise 8.1(b) where the fluctuations in magnetization gave the susceptibility in the Ising model, and eqn 6.13 where the energy fluctuations were related to the specific heat. Equation 10.49 shows in general that fluctuations in spatially-averaged quantities vanish in the thermodynamic limit  $V \rightarrow \infty$ :

$$\langle \langle s \rangle_{\text{space}}^2 \rangle = \frac{k_B T \tilde{\chi}_0(\mathbf{0})}{V} \quad (10.50)$$

so long as the uniform susceptibility stays finite.



**Fig. 10.9** The susceptibility  $\chi(\mathbf{r} = \mathbf{0}, t)$  for a hypothetical system with two characteristic relaxation times. Here  $\chi(\mathbf{r}, t)$  gives the response to an impulse at a time  $t$  in the past; causality requires that there be no response *preceding* the impulse, so  $\chi(\mathbf{r}, t) = 0$  for  $t < 0$ .

<sup>24</sup>Remember that the susceptibility and the correlated fluctuations are with respect to the average properties of the phase. So in eqn 10.49, if the average magnetization  $\langle s \rangle$  is not zero (in a ferromagnet or in an external field), one must use the correlation function for the fluctuations about the mean  $\hat{C}(\mathbf{k}, t = 0) = \int d\mathbf{r} \langle (s(\mathbf{r} + \mathbf{x}) - \langle s \rangle)(s(\mathbf{x}) - \langle s \rangle) \rangle$ . This is called the *connected* correlation function. This does not usually affect the susceptibility except at  $\mathbf{k} = \mathbf{0}$ .

## 10.8 The fluctuation-dissipation theorem

Now we turn to computing the dynamic susceptibility. It too is related to the correlation function, via the *fluctuation-dissipation* theorem.

How can we compute  $\chi(\mathbf{r}, t)$ , the space-time evolution after we kick the system at  $\mathbf{r} = t = 0$ ? We know the time evolution starting from an imposed *initial condition* is given by the Green's function  $G(\mathbf{r}, t)$ . We can impose an initial condition using a static force  $f(\mathbf{x}, t) = f(\mathbf{x})$  for  $t < 0$ , and release it at  $t = 0$  so  $f(\mathbf{x}, t) = 0$  for  $t > 0$ . We can then match<sup>25</sup> the Green's function time evolution  $s(\mathbf{x}, t) = \int d\mathbf{x}' G(\mathbf{x} - \mathbf{x}', t) s(\mathbf{x}', 0)$  with that given by the susceptibility  $s(\mathbf{x}, t) = \int_{-\infty}^0 dt' \int d\mathbf{x}' f(\mathbf{x}') \chi(\mathbf{x} - \mathbf{x}', t - t')$ .

Let us work it out for the ideal gas, where  $\chi_0(\mathbf{r}) = \delta(\mathbf{r})/\alpha$  (eqn 10.43), so  $\rho(\mathbf{x}, 0) = f(\mathbf{x})/\alpha$ . The subsequent time evolution is given by the Green's function  $G(\mathbf{x}, t)$ , which we have seen for the ideal gas gives the correlation function  $C^{\text{ideal}}(\mathbf{x}, t) = G(\mathbf{x}, t)/(\beta\alpha)$  by Onsager's regression hypothesis (eqn 10.26):

$$\begin{aligned} \rho(\mathbf{x}, t) &= \int d\mathbf{x}' \rho(\mathbf{x}', 0) G(\mathbf{x} - \mathbf{x}', t) = \int d\mathbf{x}' \frac{f(\mathbf{x}')}{\alpha} G(\mathbf{x} - \mathbf{x}', t) \\ &= \int d\mathbf{x}' f(\mathbf{x}') \beta C^{\text{ideal}}(\mathbf{x} - \mathbf{x}', t). \end{aligned} \quad (10.56)$$

We match against  $\rho(\mathbf{x}, t)$  written using the dynamical susceptibility. Since  $f(\mathbf{x}, t) = 0$  for  $t > 0$  the formula involves integrals up to time

<sup>25</sup>We can do this for a general order parameter field  $s(\mathbf{x}, t)$ . We start with an initial condition defined by a static external field  $f(\mathbf{x})$ , which is given by  $\widehat{s}(\mathbf{k}, t = 0) = \widetilde{\chi}_0(\mathbf{k}) \widetilde{f}(\mathbf{k})$ . The subsequent time evolution is given by convolving with the Green's function  $G(\mathbf{x}, t)$  (eqn 2.34), which is the same as multiplying by  $\widehat{G}(\mathbf{k}, t)$ :

$$\widehat{s}(\mathbf{k}, t) = \widetilde{\chi}_0(\mathbf{k}) \widetilde{f}(\mathbf{k}) \widehat{G}(\mathbf{k}, t). \quad (10.51)$$

We can also find an equation for  $\widehat{s}(\mathbf{k}, t)$  by using the dynamic susceptibility, eqn 10.29, and the fact that  $f(t') = 0$  for  $t' > 0$ :

$$s(\mathbf{x}, t) = \int d\mathbf{x}' \int_{-\infty}^t dt' \chi(\mathbf{x} - \mathbf{x}', t - t') f(\mathbf{x}', t') = \int d\mathbf{x}' \int_{-\infty}^0 dt' \chi(\mathbf{x} - \mathbf{x}', t - t') f(\mathbf{x}') = \int d\mathbf{x}' \int_t^{\infty} d\tau \chi(\mathbf{x} - \mathbf{x}', \tau) f(\mathbf{x}'), \quad (10.52)$$

so

$$\widehat{s}(\mathbf{k}, t) = \int_t^{\infty} d\tau \widehat{\chi}(\mathbf{k}, \tau) \widetilde{f}(\mathbf{k}). \quad (10.53)$$

This is true for any  $\widetilde{f}(\mathbf{k})$ , so with eqn 10.51, we find  $\int_t^{\infty} d\tau \widehat{\chi}(\mathbf{k}, \tau) = \widetilde{\chi}_0(\mathbf{k}) \widehat{G}(\mathbf{k}, t)$ . Now from the last section, eqn 10.45, we know  $\widetilde{\chi}_0(\mathbf{k}) = \beta \widehat{C}(\mathbf{k}, 0)$ . From the Onsager regression hypothesis, the Green's function  $\widehat{G}(\mathbf{k}, t)$  for  $s$  has the same evolution law as is obeyed by the correlation function  $C$  (eqn 10.25), so  $\widehat{C}(\mathbf{k}, 0) \widehat{G}(\mathbf{k}, t) = \widehat{C}(\mathbf{k}, t)$ . Hence

$$\int_t^{\infty} d\tau \widehat{\chi}(\mathbf{k}, \tau) = \beta \widehat{C}(\mathbf{k}, 0) \widehat{G}(\mathbf{k}, t) = \beta \widehat{C}(\mathbf{k}, t). \quad (10.54)$$

Differentiating both sides with respect to time yields the fluctuation-dissipation theorem in  $\mathbf{k}$ -space:

$$\widehat{\chi}(\mathbf{k}, t) = -\beta \frac{\partial \widehat{C}(\mathbf{k}, t)}{\partial t}. \quad (10.55)$$

zero; we change variables to  $\tau = t - t'$ :

$$\begin{aligned}\rho(\mathbf{x}, t) &= \int d\mathbf{x}' \int_{-\infty}^0 dt' f(\mathbf{x}') \chi(\mathbf{x} - \mathbf{x}', t - t') \\ &= \int d\mathbf{x}' f(\mathbf{x}') \int_t^{\infty} d\tau \chi(\mathbf{x} - \mathbf{x}', \tau).\end{aligned}\quad (10.57)$$

Comparing these two formulæ, we see that

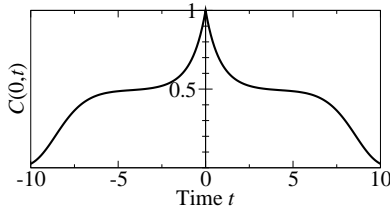
$$\beta C^{\text{ideal}}(\mathbf{r}, t) = \int_t^{\infty} d\tau \chi(\mathbf{r}, \tau).\quad (10.58)$$

Taking the derivative of both sides, we derive one form of the *fluctuation-dissipation theorem*:

$$\chi^{\text{ideal}}(\mathbf{r}, t) = -\beta \frac{\partial C^{\text{ideal}}}{\partial t} \quad (t > 0).\quad (10.59)$$

The fluctuation-dissipation theorem in this form is true in general for the linear response of classical equilibrium systems (see note 25). The linear dynamic susceptibility  $\chi$  of a general order parameter field  $s(\mathbf{x}, t)$  with correlation function  $C(\mathbf{x}, t)$  is given by

$$\chi(\mathbf{x}, t) = -\beta \frac{\partial C(\mathbf{x}, t)}{\partial t} \quad (t > 0).\quad (10.60)$$



**Fig. 10.10 Time-time correlation function.** The time-time correlation function  $C(\mathbf{r} = \mathbf{0}, \tau)$  for the same hypothetical system whose susceptibility was shown in Fig. 10.9.

What happens for  $t < 0$ ? The correlation function must be symmetric in time (Fig. 10.10) since the equilibrium state is invariant under time-reversal symmetry:

$$\begin{aligned}C(\mathbf{r}, \tau) &= \langle s(\mathbf{x}, t) s(\mathbf{x} + \mathbf{r}, t + \tau) \rangle \\ &= \langle s(\mathbf{x}, t) s(\mathbf{x} + \mathbf{r}, t - \tau) \rangle = C(\mathbf{r}, -\tau).\end{aligned}\quad (10.61)$$

But  $\chi$  must be zero for  $t < 0$  (Fig. 10.9) by causality:

$$\chi(\mathbf{r}, t) = 0 \quad (t < 0).\quad (10.62)$$

We can see why it is called the *fluctuation-dissipation* theorem by looking at the AC version of the law. Again, for convenience, we ignore the spatial degrees of freedom. Using eqns 10.60 and 10.62, and integrating by parts, we find

$$\begin{aligned}\tilde{\chi}(\omega) &= \int_{-\infty}^{\infty} dt \chi(t) e^{i\omega t} = -\beta \int_0^{\infty} dt \frac{\partial C}{\partial t} e^{i\omega t} \\ &= -\beta C(t) e^{i\omega t} \Big|_0^{\infty} + i\omega \beta \int_0^{\infty} dt C(t) e^{i\omega t}.\end{aligned}\quad (10.63)$$

Now, the first term is real and  $C(t) = C(-t)$ , so we may write the imaginary part of the susceptibility as

$$\begin{aligned}\chi''(\omega) &= \text{Im}[\tilde{\chi}(\omega)] = \beta \omega \int_0^{\infty} dt C(t) \cos(\omega t) \\ &= \frac{\beta \omega}{2} \int_{-\infty}^{\infty} dt C(t) e^{i\omega t} = \frac{\beta \omega}{2} \tilde{C}(\omega).\end{aligned}\quad (10.64)$$



This is the AC version of the (classical) fluctuation-dissipation theorem, which we state again:

$$\chi''(\omega) = \frac{\beta\omega}{2}\tilde{C}(\omega). \quad (10.65)$$

Using this result and eqn 10.37 relating the power dissipated  $p(\omega)$  to  $\chi''$ , we find

$$\begin{aligned} p(\omega) &= \frac{\omega|f_\omega|^2}{2}\chi''(\omega) = \frac{\omega|f_\omega|^2}{2}\frac{\beta\omega}{2}\tilde{C}(\omega) \\ &= \frac{\beta\omega^2|f_\omega|^2}{4}\tilde{C}(\omega). \end{aligned} \quad (10.66)$$

This tells us that the power dissipated  $p(\omega)$  under an external forcing  $f_\omega$  is given in terms of the correlation function of the spontaneous fluctuations  $\tilde{C}(\omega)$ ; hence the name fluctuation-dissipation theorem.

Notice that the fluctuation-dissipation theorem applies only to equilibrium systems. (There are several interesting but much more speculative attempts to generalize it to non-equilibrium systems.) Also notice that we have ignored quantum mechanics in our derivation.<sup>26</sup> Indeed there are quantum-mechanical corrections; the fully quantum version of the fluctuation-dissipation theorem is

$$\chi''(\mathbf{k}, \omega) = \text{Im}[\tilde{\chi}(\mathbf{k}, \omega)] = \frac{1}{2\hbar}(1 - e^{-\beta\hbar\omega})\tilde{C}(\mathbf{k}, \omega). \quad (10.67)$$

At high temperatures,  $1 - e^{-\beta\hbar\omega} \sim \beta\hbar\omega$  and we regain our classical result, eqn 10.65.

## 10.9 Causality and Kramers–Krönig

The susceptibility  $\chi(t)$  (again, dropping the positions for simplicity) is a real-valued function on the half-line  $t > 0$ . The frequency-dependent susceptibility is composed of two real-valued functions  $\chi'(\omega)$  and  $\chi''(\omega)$  on the entire line. We can use the symmetries  $\tilde{\chi}(-\omega) = \tilde{\chi}^*(\omega)$  to reduce this to two real-valued functions on the half-line  $\omega > 0$ , but it still seems like  $\tilde{\chi}(\omega)$  contains twice the information of  $\chi(t)$ . It makes it plausible that  $\chi'$  and  $\chi''$  might be related somehow. Suppose we measure the frequency-dependent absorption of the material, and deduce  $\chi''(\mathbf{k}, \omega)$ . Can we find the real part of the susceptibility  $\chi'(\mathbf{k}, \omega)$ ?

It is a remarkable fact that we can find a formula for  $\chi'(\omega)$  in terms of  $\chi''(\omega)$ . This relation is called the *Kramers–Krönig relation*, and it follows from *causality*. For this argument, you will need to know some complex analysis.<sup>27</sup>

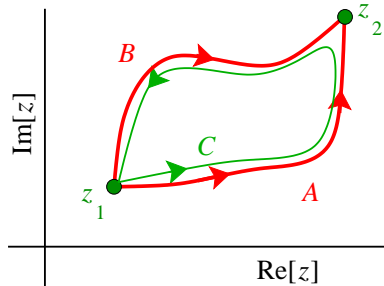
We know that  $\chi(t) = 0$  for  $t < 0$ , because the laws of nature are causal; the response cannot precede the perturbation. What does this imply about  $\chi(\omega) = \int dt \chi(t)e^{i\omega t}$ ? Consider the function  $\chi$  as a function of a complex frequency  $\omega = u + iv$ :

$$\chi(u + iv) = \int_0^\infty dt \chi(t)e^{iut}e^{-vt}. \quad (10.68)$$

<sup>26</sup>One can also derive the fluctuation-dissipation theorem quantum mechanically, and then use it to derive the Onsager regression hypothesis [43].

<sup>27</sup>If you have not heard of Cauchy's theorem, read on—you will be getting a preview of the key result in complex analysis.

<sup>28</sup>Analytic means that Taylor series expansions converge. It is amazing how many functions in physics are analytic; it seems we almost always can assume power series make sense. We have discussed in Section 8.3 that material properties are analytic functions of the parameters inside phases; we have discussed in Exercise 9.5 that the free energy for finite systems (and for finite coarse-grainings) is an analytic function of the order parameter and its gradients. Here we find yet another excuse for finding analytic functions: causality!



**Fig. 10.11 Cauchy’s theorem.** For  $f(z)$  to have a well-defined complex integral from  $z_1$  to  $z_2$ , the contour integral over any two paths  $A$  and  $B$  connecting the points must agree. Hence the integral along a closed curve  $C$  formed by traversing  $A$  forward and  $B$  backward must be zero. Cauchy’s theorem is thus the condition for the complex integral to be well defined, independent of the path from  $z_1$  to  $z_2$ .

<sup>29</sup>Many will recognize this as being related to Cauchy’s integral formula, which states that

$$\oint_C \frac{f(z')}{z' - z} dz' = 2\pi i f(z) N, \quad (10.73)$$

where  $N$  is the *winding number* of the path (the number of times it encircles  $z$  counter-clockwise). A counter-clockwise loop plowing straight through  $z$  is the special case with  $N = \frac{1}{2}$ .

It converges nicely for  $v > 0$ , but looks dubious for  $v < 0$ . In the complex  $\omega$  plane, the fast convergence for  $v > 0$  implies that  $\chi(\omega)$  is analytic in the upper half-plane.<sup>28</sup> Also, it seems likely that there will be singularities (e.g., poles) in  $\tilde{\chi}(\omega)$  in the lower half-plane ( $v < 0$ ).

We now apply a deep theorem of complex analysis. If  $C$  is a closed curve (or *contour*) in the complex  $z$  plane, and  $f(z)$  is analytic everywhere in a region that encloses the contour, *Cauchy’s theorem* states that the line integral of  $f(z)$  around  $C$  is zero:

$$\oint_C f(z') dz' = 0. \quad (10.69)$$

Cauchy’s theorem (which we shall not prove) is amazing, but it has a simple interpretation: it is the condition for the integral of  $f(z)$  to exist as a complex function (Fig. 10.11).

Now consider the integral

$$\oint_{C_\omega} \frac{\tilde{\chi}(\omega')}{\omega' - \omega} d\omega' = 0 \quad (10.70)$$

along the contour  $C_\omega$  of Fig. 10.12. The integral is zero because  $\tilde{\chi}(\omega')$  is analytic in the upper half-plane, and thus so also is  $\tilde{\chi}(\omega')/(\omega' - \omega)$ , except at the point  $\omega' = \omega$  which is dodged by the small semicircle (of radius  $\epsilon$ ). The contribution of the large semicircle to this contour integral can be shown to vanish as its radius  $R \rightarrow \infty$ . The contribution of the small clockwise semicircle  $\omega' = \omega + \epsilon \exp(i\theta)$ ,  $\pi > \theta > 0$ , is

$$\begin{aligned} \int_{\text{small semicircle}} \frac{\tilde{\chi}(\omega')}{\omega' - \omega} d\omega' &\approx \tilde{\chi}(\omega) \int_{\text{small semicircle}} \frac{1}{\omega' - \omega} d\omega' \\ &= \tilde{\chi}(\omega) \log(\omega' - \omega) \Big|_{\omega' = \omega + \epsilon \exp(i\theta)}^{\omega' = \omega + \epsilon \exp(i\pi)} \\ &= \tilde{\chi}(\omega) [\log \epsilon - (\log \epsilon + i\pi)] = -i\pi \tilde{\chi}(\omega). \end{aligned} \quad (10.71)$$

The two horizontal segments, as  $R \rightarrow \infty$  and  $\epsilon \rightarrow 0$ , converge to the integral over the whole real axis:

$$\lim_{\epsilon \rightarrow 0} \left[ \int_{-\infty}^{\omega' - \epsilon} + \int_{\omega' + \epsilon}^{\infty} \right] \frac{\tilde{\chi}(\omega')}{\omega' - \omega} d\omega' = \text{PV} \int_{-\infty}^{\infty} \frac{\tilde{\chi}(\omega')}{\omega' - \omega} d\omega', \quad (10.72)$$

where the left-hand side is the definition of the *principal value* (PV), the limit as the pole is approached symmetrically from either side.

Since the contribution of the semicircles and the horizontal segments sum to zero by Cauchy’s theorem, eqn 10.71 must equal minus eqn 10.72, so<sup>29</sup>

$$\tilde{\chi}(\omega) = \frac{1}{\pi i} \int_{-\infty}^{\infty} \frac{\tilde{\chi}(\omega')}{\omega' - \omega} d\omega', \quad (10.74)$$

where the right-hand side is understood as the principal value.

Notice the  $i$  in the denominator. This implies that the real part of the integral gives the imaginary part of  $\tilde{\chi}$  and vice versa. In particular,

$$\chi'(\omega) = \text{Re}[\tilde{\chi}(\omega)] = \frac{1}{\pi} \int_{-\infty}^{\infty} \frac{\text{Im}[\tilde{\chi}(\omega')]}{\omega' - \omega} d\omega' = \frac{1}{\pi} \int_{-\infty}^{\infty} \frac{\chi''(\omega')}{\omega' - \omega} d\omega'. \quad (10.75)$$

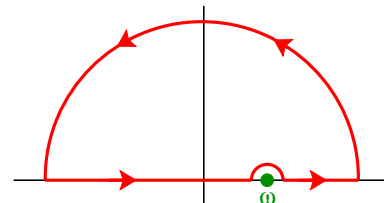
It is traditional to simplify it a bit more, by noticing that  $\chi''(\omega) = -\chi''(-\omega)$ , so

$$\begin{aligned}\chi'(\omega) &= \frac{1}{\pi} \int_0^\infty \chi''(\omega') \left( \frac{1}{\omega' - \omega} - \frac{1}{-\omega' - \omega} \right) d\omega' \\ &= \frac{2}{\pi} \int_0^\infty \chi''(\omega') \frac{\omega'}{\omega'^2 - \omega^2} d\omega'.\end{aligned}\quad (10.76)$$

Hence in principle one can measure the imaginary, dissipative part of a frequency-dependent susceptibility and do a simple integral to get the real, reactive part. Conversely,

$$\chi''(\omega) = -\frac{2\omega}{\pi} \int_0^\infty \chi'(\omega') \frac{1}{\omega'^2 - \omega^2} d\omega'.\quad (10.77)$$

These are the *Kramers–Krönig relations*. In practice they are a challenge to use; to deduce the real part, one must measure (or approximate) the dissipative imaginary part at all frequencies, from deep infra-red to X-ray.



**Fig. 10.12 Kramers–Krönig contour.** A contour  $C_\omega$  in the complex  $\omega'$  plane. The horizontal axis is  $\text{Re}[\omega']$  and the vertical axis is  $\text{Im}[\omega']$ . The integration contour runs along the real axis from  $-\infty$  to  $\infty$  with a tiny semicircular detour near a pole at  $\omega$ . The contour is closed with a semicircle back at infinity, where  $\chi(\omega')$  vanishes rapidly. The contour encloses no singularities, so Cauchy's theorem tells us the integral around it is zero.

## Exercises

In *Microwave background radiation*, we study the first of all correlation functions, left to us from the Big Bang. In *Pair distributions and molecular dynamics*, we explore the spatial atom-atom pair distribution function in molecular dynamics simulations of liquids and gases.

The next five exercises focus on purely temporal fluctuations and evolution. In *Damped oscillator* and *Spin* we explore the various relations between correlation, response, and dissipation in the two most commonly observed and studied systems. *Telegraph noise in nanojunctions* ties correlation functions to Markov chains and detailed balance in a modern experimental context. *Fluctuation-dissipation: Ising* verifies our main theorem in a numerical simulation. *Noise and Langevin equations* explores the thermal fluctuations from the heat bath, and how they return the energy to the system that is withdrawn by dissipation. This last exercise provides the theoretical justification for one type of heat bath for molecular dynamics simulations.

We conclude with two systems fluctuating and responding both in space and in time. (This doubles the number of Fourier transforms, but conceptually these cases are no more difficult.) *Magnet dynamics* guides us through a complete calculation of the correlation and susceptibil-

ity for an order parameter field with stiffness to gradients (unlike the ideal gas). Finally, *Quasiparticle poles and Goldstone's theorem* models ultrasonic attenuation in gases, and shows how 'eigenmodes' with lifetimes are given formal credibility as complex-frequency singularities in the susceptibility.

### (10.1) Microwave background radiation.<sup>30</sup> (Astrophysics) ③

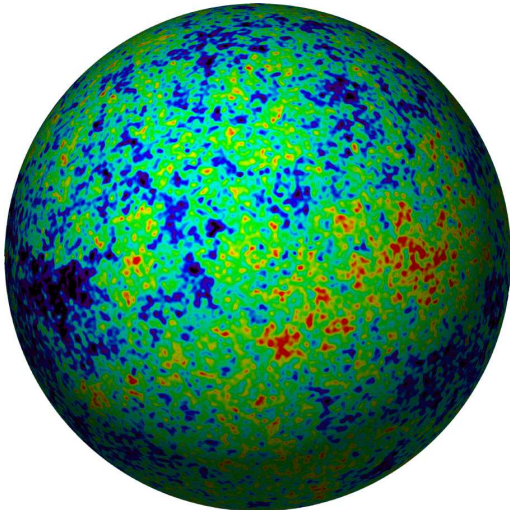
In Exercise 7.15, we studied the the microwave background radiation. This radiation was emitted about 380 000 years after the Big Bang, when the electrically charged electrons and protons combined into neutral atoms and hence almost completely stopped scattering the photons [143]. We saw there that the spectrum is almost perfectly a black-body spectrum, indicating that the photons at the decoupling time were in thermal equilibrium.

The Universe was not only in local thermal equilibrium at that time, but seemed to have reached precisely the same temperature in all directions (a global equilibrium). Apart from our galaxy (which emits microwaves) and a few other

<sup>30</sup>This exercise was developed with assistance from Ira Wasserman, Eanna Flanagan, Rachel Bean, and Dale Fixsen.

non-cosmological point sources, the early experiments could not detect any angular fluctuations in the microwave temperature. This uniformity lends support to a model called *inflation*. In the inflationary scenario, space-time goes through a period of rapid expansion, leaving the observable Universe with a uniform density.

More discriminating experiments next detected an overall Doppler shift of the temperature field, which they used to measure the absolute velocity of the Sun.<sup>31</sup> The Sun has a net velocity of about a million miles per hour in the direction of the constellation Leo.



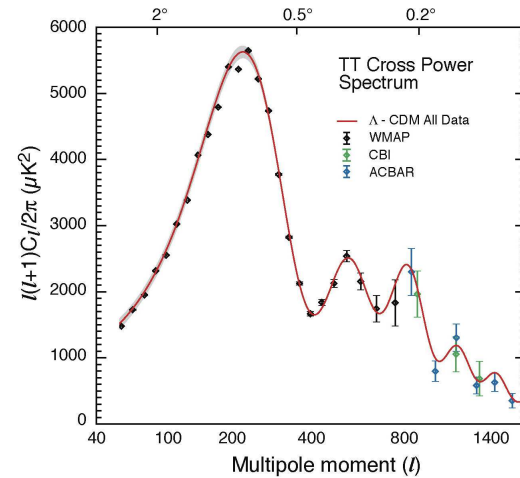
**Fig. 10.13 Map of the microwave background radiation**, from the NASA/WMAP Science Team [137]. Variation in temperature of the microwave background radiation, after the constant term, dipole term, and the radiation from our galaxy are subtracted out, from WMAP, the Wilkinson Microwave Anisotropy Probe. The satellite is at the center of the sphere, looking outward. The fluctuations are about one part in 100 000.

Subsequent experiments finally saw more interesting variations in the microwave background radiation, shown in Fig. 10.13. We interpret these fluctuations as the ripples in the tempera-

ture, evolving according to a wave equation<sup>32</sup>

$$(1 + R) \frac{\partial^2 \Theta}{\partial t^2} = \frac{c^2}{3} \nabla^2 \Theta, \quad (10.78)$$

where  $c$  is the speed of light in a vacuum,  $\Theta$  is the temperature fluctuation  $\Delta T/T$ ,  $t$  is the time, and  $R$  is due to the contribution of matter to the total density (see Exercise 7.15 and [60]).



**Fig. 10.14 Correlation function of microwave radiation** in Fourier space, from the NASA/WMAP Science Team [137]. Temperature variations of the microwave background radiation, written in spherical harmonics (roughly an angular Fourier transform). You can think of  $l$  for the multipole moment as roughly corresponding to wavevector  $k_l = 2\pi l/L$ .<sup>33</sup> The curve through the data is a more complete theoretical fit, similar in spirit to this exercise.

What kind of initial correlations in the fluctuations does the inflationary scenario predict? The inflation theory predicts that at very early times the Universe was left in a state which we can think of as having tiny, random variations in temperature and density, and with zero initial velocities. These initial variations were not uncorrelated (white noise). Instead, inflation leaves

<sup>31</sup>Einstein’s theory states that all motion is relative: the laws of physics do not depend on how fast the Sun is moving with respect to the distant galaxies. The Big Bang, through the microwave background radiation, establishes a preferred reference frame. We noted in Section 5.1 that the Big Bang is also responsible for the arrow of time; it (dramatically) broke time-reversal invariance and (subtly) breaks Lorentz invariance.

<sup>32</sup>This equation is for ‘co-moving time-orthogonal gauge’, I am told.

<sup>33</sup>The first peak is at  $l \sim 220$ ; they estimate the second peak to be at  $l = 546 \pm 10$ . Note that the horizontal axis in this plot is neither linear nor logarithmic.

the Universe in a state with *scale-invariant* initial velocity fields, starting with a power law

$$\widehat{C}(\mathbf{k}, t = 0) = |\widehat{\Theta}(\mathbf{k}, t = 0)|^2 / V = Ak^{n_s-3}, \tag{10.79}$$

with  $n_s \approx 1$  for most inflation theories. (Remember that the absolute square of the transform is the transform of the correlation function,  $|\widehat{\Theta}(\mathbf{k}, t)|^2 \propto \widehat{C}(\mathbf{k}, t)$ , eqn A.21.)

Let us model the Universe as a one-dimensional box with length  $L$  and periodic boundary conditions. Let us solve for the time evolution of the equal-time correlation function<sup>34</sup>  $C(x - x', t) = \langle \Theta(x, t)\Theta(x', t) \rangle$  at  $t = 380\,000$  years given initial conditions  $(\partial\Theta/\partial t)|_{t=0} = 0$  and  $\Theta(x, t = 0)$  random but with scale-invariant correlations (eqn 10.79). We can then evolve each Fourier component, and calculate the correlation function in  $\mathbf{k}$ -space at the decoupling time.

(a) *Given an initial  $\widehat{\Theta}(\mathbf{k}, t = 0)$  and assuming  $(\partial\widehat{\Theta}/\partial t)|_{t=0} = 0$ , calculate  $\widehat{\Theta}(\mathbf{k}, t)$  from eqn 10.78. Calculate  $\widehat{C}(\mathbf{k}, t) = \langle |\widehat{\Theta}(\mathbf{k}, t)|^2 \rangle$  in terms of  $A$ ,  $c$ , and  $R$  given  $n_s = 1$ . For what value of  $L$  (in light years and in centimeters) will  $k_{220}$  be the first peak<sup>35</sup> of  $k^2\widehat{C}(\mathbf{k}, t)$  at the decoupling time, if  $R = 0.7$ ? (Hint:  $c = 3 \times 10^{10}$  cm/s,  $t = 380\,000$  years, and there happen to be about  $\pi \times 10^7$  seconds in a year.)*

$L$  can be interpreted as roughly the ‘circumference’ of that part of the Universe visible in the cosmic background radiation at the time of decoupling.

(b) *Plot  $l(l + 1)\widehat{C}(k_l, t)$  at the decoupling time, for  $R = 0.7$  and  $A = 1$ , from  $l = 40$  to  $l = 1500$ . Compare with Fig. 10.14.*

Your correlation function should look much less structured than the actual one. We have ignored many important phenomena in this exercise. At wavelengths long compared to the speed of sound times the age of the Universe ( $l < 160$ , roughly up to the first peak) the wave equation has not had time to start working. At shorter wavelengths ( $l > 1100$ ) the waves become damped because the photon mean-free path among the baryons gets large. A calculation much like the

one you solved, but including these effects and others (like gravity), shifts the higher peak positions and changes their amplitudes resulting in the curve in Fig. 10.14. For further details, see [60, 137].

(10.2) **Pair distributions and molecular dynamics.**<sup>36</sup> (Computation) ③

Many scattering experiments measure the correlations between atomic positions. Let our system have  $N$  particles in a volume  $V$ .<sup>37</sup> The mean density in a system with atoms at positions  $\mathbf{x}_i$

$$\rho(\mathbf{x}) = \left\langle \sum_i \delta(\mathbf{x} - \mathbf{x}_i) \right\rangle, \tag{10.80}$$

and the density–density correlation function<sup>38</sup>

$$C(\mathbf{x}, \mathbf{x}') = \left\langle \sum_{i, j \neq i} \delta(\mathbf{x} - \mathbf{x}_i)\delta(\mathbf{x}' - \mathbf{x}_j) \right\rangle \tag{10.81}$$

are used to define the *pair correlation function*  $g(\mathbf{x}, \mathbf{x}')$ :

$$g(\mathbf{x}, \mathbf{x}') = \frac{C(\mathbf{x}, \mathbf{x}')}{\rho(\mathbf{x})\rho(\mathbf{x}')} = \frac{C(\mathbf{x} - \mathbf{x}')}{(N/V)^2}. \tag{10.82}$$

Here the last equality is valid for homogeneous systems like liquids and gases.<sup>39</sup>

(a) *Show analytically from equation 10.80 that  $\rho(\mathbf{x})$  for a homogeneous system is the indeed the average density  $N/V$ . Show that  $g(\mathbf{x}, \mathbf{x}') = g(\mathbf{x} - \mathbf{x}') = g(\mathbf{r})$ , where*

$$g(\mathbf{r}) = \left\langle \frac{V}{N^2} \sum_{i, j \neq i} \delta(\mathbf{r} - \mathbf{r}_{ij}) \right\rangle \tag{10.83}$$

and  $\mathbf{r}_{ij} = \mathbf{x}_i - \mathbf{x}_j$  is the vector separating the positions of atoms  $i$  and  $j$ . If the system is homogeneous and the atoms are uncorrelated (i.e., an ideal gas), show that  $g(\mathbf{r}) \equiv 1$ . If the potential energy is the sum of pair interactions with potential  $E(\mathbf{r}_{ij})$ , write the potential energy as an integral over three-dimensional space  $\mathbf{r}$  involving  $N$ ,  $V$ ,  $g(\mathbf{r})$ , and  $E(\mathbf{r})$ .

Usually  $g(\mathbf{r}) \rightarrow 1$  as  $r \rightarrow \infty$ ; the correlations die away as the separation grows.

<sup>34</sup>Time here is not the time lag between the two measurements, but rather the time evolved since the Universe stopped inflating (similar to the coarsening correlation function  $C_{\text{coar}}(\mathbf{x}, t)$  in Section 10.1).

<sup>35</sup>We multiply by  $k^2$  to correspond roughly to the vertical axis  $l(l + 1)C_l$  of Fig. 10.14.

<sup>36</sup>This exercise was developed in collaboration with Neil W. Ashcroft and Christopher R. Myers.

<sup>37</sup>We will use periodic boundary conditions, so the edges of the container do not break the translational symmetry.

<sup>38</sup>Warning: In the theory of liquids,  $C$  is used for another function, the Ornstein–Zernike direct correlation function.

<sup>39</sup>The pair correlation function represents the degree to which atomic positions fluctuate together, beyond the clumping implied by the possibly inhomogeneous average density. For example, three-dimensional crystals have a long-range broken translational symmetry;  $\rho(\mathbf{x})$  will have peaks at the lattice sites even after averaging over thermal vibrations.

Liquids and gases are also isotropic; the pair correlation function  $g$  must be rotation invariant, and hence can only depend on the distance  $r = |\mathbf{r}|$ . A typical molecular dynamics code will have a fast `NeighborLocator` routine, which will return the `HalfNeighbor` pairs of atoms  $j < i$  with  $|r_{ij}|$  less than a given cut-off. A histogram of the distances between these nearby points, suitably rescaled, is a convenient way of numerically estimating the pair correlation function. Let the histogram  $h(r_n)$  give the number of such pairs in our system with  $r_n < r < r_n + \Delta r$ .

(b) For an isotropic, homogeneous system in three dimensions, show

$$g(\mathbf{r}) = \frac{2V}{N^2} \frac{h(r)}{4\pi r^2 \Delta r}. \quad (10.84)$$

What is the corresponding formula in two dimensions?

Download our molecular dynamics software [10] from the text web site [129]. In our simulation, we use the Lennard–Jones potential, in which all pairs of atoms interact with an energy with a short-range repulsion  $\sim 1/r^{12}$  and a long-range (van der Waals) attraction  $\sim 1/r^6$ :

$$E_{\text{pair}}(r) = 4\epsilon \left( \left( \frac{\sigma}{r} \right)^{12} - \left( \frac{\sigma}{r} \right)^6 \right). \quad (10.85)$$

Lennard–Jones is a reasonable approximation for the interatomic forces between noble gas atoms like argon. In our simulation, we choose the length scale  $\sigma$  and the energy scale  $\epsilon$  both equal to one.

(c) Plot the Lennard–Jones pair potential as a function of  $r$ , choosing a vertical scale so that the attractive well is visible. Where is the minimum-energy spacing between two atoms? Can you see why the repulsion is called ‘hard core’?

*Gas.* We start with a simulated gas, fairly near the vapor pressure.

(d) Simulate a two-dimensional gas of Lennard–Jones atoms, at a temperature  $T = 0.5\epsilon$  and a density  $\rho = 0.05/\sigma^2$ . Calculate the pair distribution function for the gas for  $0 < r < 4\sigma$ . Note the absence of pairs at close distances. Can you observe the effects of the attractive well in the potential, both visually and in the pair correlation function?

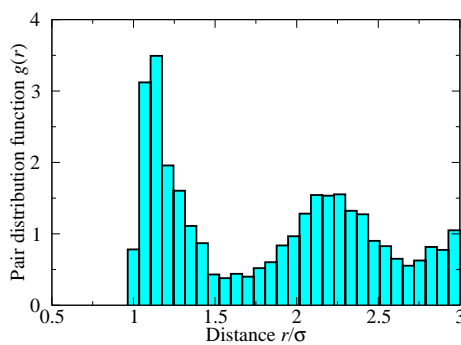
In a low-density, high-temperature gas the correlations between atoms primarily involve only two atoms at once. The interaction energy of a pair of atoms in our system is  $E_{\text{pair}}(r)$ , so in this

limit

$$g_{\text{theory}}(r) \propto \exp(-E(r)/k_B T). \quad (10.86)$$

Since  $E(r) \rightarrow 0$  and  $g(r) \rightarrow 1$  as  $r \rightarrow \infty$ , the constant of proportionality should be one.

(e) Compare  $g(r)$  from part (d) with  $g_{\text{theory}}$  for a system with density  $\rho = 0.05/\sigma^2$ . Do they agree well? Do they agree even better at higher temperatures or lower densities, where multi-particle interactions are less important?



**Fig. 10.15** Pair distribution function  $g(r)$  for a two-dimensional Lennard–Jones liquid.

*Liquid.* We now turn to a liquid, at the same temperature as our gas but at a higher density.

(f) Simulate a liquid, at  $\rho = 0.75/\sigma^2$  and  $T = 0.5$ . Note from the animation that each atom in the two-dimensional simulation has around six nearest-neighbors, at nearly the minimum-energy distance. Calculate the pair distribution function. Can you explain the features you see in terms of nearest-neighbors and second-nearest neighbors?

(g) If we define the coordination number of a liquid atom as all those with distances less than the position of the dip between nearest and next-nearest neighbors in  $g(r)$ , what is the mean number of near neighbors for your two-dimensional liquid?

In most (three-dimensional) simple elemental liquids, the coordination number defined by this criterion is between 11 and 11.5. (The close-packed crystals have twelve nearest neighbors). The main exceptions are the group IV elements (carbon, silicon, germanium, ...) where the bonding is strongly angle dependent and the number of liquid near neighbors is smaller,

around 5.5; their crystalline phases have three or four covalently-bonded neighbors.

*Crystal.* In a three-dimensional crystal, the atoms vibrate around their equilibrium lattice positions (with only rare hops between lattice sites as atoms exchange with one another or vacancies move through the crystal). If these vibrations become large compared to the lattice constant, then surely the crystal will melt. The *Lindemann criterion* notes that for simple crystals, melting usually occurs when the thermal vibrations away from the lattice positions are about 10% of the interatomic spacing.

(Note how weird this is. A three-dimensional crystal, billions of atoms across, thermally vibrating almost enough to melt, still holds its atoms in rigid registry within fractions of an Angstrom.)

This is not true in two dimensions, where the lattice is not as stiff and thermal fluctuations are more severe.<sup>40</sup> The Lindemann criterion of course also implies that the typical variation in the nearest-neighbor separations for three-dimensional crystals stays much smaller than the lattice constant at the melting point. Is this version of the Lindemann criterion true of two-dimensional crystals?

(h) *Simulate a crystal, at  $T = 0.1$  starting from a hexagonal crystal with interatomic spacing approximating the minimum of the pair potential. Calculate the isotropic spatial average of the pair correlation function.<sup>41</sup> By what percentage does the nearest-neighbor separation fluctuate? Are they small compared to the lattice constant? Also, can you identify which neighbors on the hexagonal lattice correspond to the second-nearest-neighbor and the third-nearest-neighbor peaks in  $g(r)$ ?*

### (10.3) Damped oscillator. ③

Let us explore further the fluctuating mass-on-a-spring (Section 6.5). The coupling of the macroscopic motion to the internal degrees of freedom eventually damps any initial macroscopic oscillation; the remaining motions are microscopic thermal fluctuations. These fluctuations can be important, however, for nanomechanical and biological systems. In addition, the damped harmonic oscillator is a classic model for many

atomic-scale physical processes, such as dielectric loss in insulators. (See [88] for a treatment by an originator of this subject.)

Consider a damped, simple harmonic oscillator, forced with an external force  $f$ , obeying the equation of motion

$$\frac{d^2\theta}{dt^2} = -\omega_0^2\theta - \gamma\frac{d\theta}{dt} + \frac{f(t)}{m}. \quad (10.87)$$

(a) *Susceptibility. Find the AC susceptibility  $\tilde{\chi}(\omega)$  for the oscillator. Plot  $\chi'$  and  $\chi''$  for  $\omega_0 = m = 1$  and  $\gamma = 0.2, 2,$  and  $5$ . (Hint: Fourier transform the equation of motion, and solve for  $\tilde{\theta}$  in terms of  $\tilde{f}$ .)*

(b) *Causality and critical damping. Check, for positive damping  $\gamma$ , that your  $\chi(\omega)$  is causal ( $\chi(t) = 0$  for  $t < 0$ ), by examining the singularities in the complex  $\omega$  plane (Section 10.9). At what value of  $\gamma$  do the poles begin to sit on the imaginary axis? The system is overdamped, and the oscillations disappear, when the poles are on the imaginary axis.*

At this point, it would be natural to ask you to verify the Kramers–Krönig relation (eqn 10.76), and show explicitly that you can write  $\chi'$  in terms of  $\chi''$ . That turns out to be tricky both analytically and numerically. If you are ambitious, try it.

(c) *Dissipation and susceptibility. Given a forcing  $f(t) = A\cos(\omega t)$ , solve the equation and calculate  $\theta(t)$ . Calculate the average power dissipated by integrating your resulting formula for  $f d\theta/dt$ . Do your answers for the power and  $\chi''$  agree with the general formula for power dissipation, eqn 10.37?*

(d) *Correlations and thermal equilibrium. Use the fluctuation-dissipation theorem to calculate the correlation function  $\tilde{C}(\omega)$  from  $\chi''(\omega)$  (see eqn 10.65), where*

$$C(t - t') = \langle \theta(t)\theta(t') \rangle. \quad (10.88)$$

*Find the equal-time correlation function  $C(0) = \langle \theta^2 \rangle$ , and show that it satisfies the equipartition theorem. (Hints: Our oscillator is in a potential well  $V(\theta) = \frac{1}{2}m\omega_0^2\theta^2$ . Also,  $(\omega_0^2 - \omega^2)^2 + C^2\omega^2 = (\omega_0^2 - \omega^2 + iC\omega)(\omega_0^2 - \omega^2 - iC\omega)$ ; do contour integration.)*

<sup>40</sup>The theory of two-dimensional crystals and how they melt has spawned many beautiful theoretical and experimental studies; look for works on the *Kosterlitz–Thouless–Halperin–Nelson–Young* transition.

<sup>41</sup>That is, use the routines you've developed for liquids and gases, ignoring the spatially dependent  $\rho(x)$  in equation 10.82 and discussed in note 39. This average still gives the correct potential energy.

(10.4) **Spin.**<sup>42</sup> (Condensed matter) ③

A spin in a solid has two states,  $s_z = \pm 1/2$  with magnetizations  $M = g\mu_B s_z$ , where  $g\mu_B$  is a constant.<sup>43</sup> Due to fluctuations in its environment, the spin can flip back and forth thermally between these two orientations. In an external magnetic field  $H$ , the spin has energy  $-M \cdot H$ . Let  $M(t)$  be the magnetization of the spin at time  $t$ . Given a time-dependent small external field  $H(t)$  along  $z$ , the expectation value of  $M$  satisfies

$$d[M(t)]_{M_i} / dt = -\Gamma [M(t)]_{M_i} + \Gamma \chi_0 H(t), \tag{10.89}$$

where  $\Gamma$  is the spin equilibration rate,  $\chi_0$  is the static magnetic susceptibility, and the averaging  $[\cdot]_{M_i}$  is over the noise provided by the environment, fixing the initial condition  $M_i = M(0)$ .

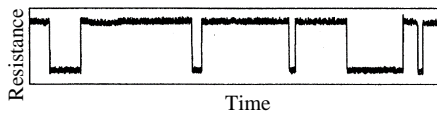
(a) In the case that the field  $H$  is time independent, use equilibrium statistical mechanics to determine  $M(H)$ . Using this formula for small  $H$ , determine  $\chi_0$  (which should be independent of  $H$  but dependent on temperature).

(b) Use the Onsager regression hypothesis to compute  $C(t) = \langle M(t)M(0) \rangle_{\text{ev}}$  at zero external field  $H = 0$ . What should it be for times  $t < 0$ ? What is  $\tilde{C}(\omega)$ , the Fourier transform of  $C(t)$ ?

(c) Assuming the classical fluctuation-dissipation theorem, derive the frequency-dependent susceptibility  $\chi(t)$  and  $\tilde{\chi}(\omega)$ .

(d) Compute the energy dissipated by the oscillator for an external magnetic field  $H(t) = H_0 \cos(\omega t)$ .

(10.5) **Telegraph noise in nanojunctions.** (Condensed matter) ③



**Fig. 10.16 Telegraph noise in a metallic nanojunction.** Resistance versus time  $R(t)$  for a copper constriction, from [109]. We label  $\alpha$  the state with low resistance  $R_\alpha$ , and  $\beta$  the state with high resistance  $R_\beta$ . The two states probably represent a local shift of an atom or a small group of atoms in the constriction from one metastable state to another.

Many systems in physics exhibit *telegraph noise*, hopping between two states at random intervals (like a telegraph key going on and then off at different intervals for dots and dashes). The nanojunction in Fig. 10.16 has two states,  $\alpha$  and  $\beta$ . It makes transitions at random, with rate  $P_{\beta \leftarrow \alpha} = P_{\beta\alpha}$  from  $\alpha$  to  $\beta$  and rate  $P_{\alpha\beta}$  from  $\beta$  to  $\alpha$ .

*Master equation.* Consider an ensemble of many identical copies of this system. Let the state of this ensemble at time  $t$  be given by  $\vec{\rho}(t) = (\rho_\alpha, \rho_\beta)$ , a vector of probabilities that the system is in the two states. This vector thus evolves according to the *master equation*

$$d\vec{\rho}/dt = M \cdot \vec{\rho}. \tag{10.90}$$

(a) What is the  $2 \times 2$  matrix  $M$  for our system, in terms of  $P_{\alpha\beta}$ ? At long times, what fraction of the time will our system be in the  $\alpha$  state,  $\langle \rho_\alpha \rangle = \lim_{t \rightarrow \infty} \rho_\alpha(t)$ ? (Notice that, unlike the Markov chains in Section 8.2, we now evolve continuously in time. Remember also that  $P_{\alpha\beta}$  increases  $\rho_\alpha$  and decreases  $\rho_\beta$ .)

(b) Find the eigenvalue-eigenvector pairs for  $M$ .<sup>44</sup> Which corresponds to the stationary state  $\vec{\rho}(\infty)$  from part (a)? Suppose that at  $t = 0$  the system is known to be in the  $\alpha$  state,  $\vec{\rho}(0) = (1, 0)$ . Write this initial condition in the basis of eigenvectors, and hence give a formula for the subsequent time evolution  $\rho_\alpha(t)$ . What is the rate of decay to the stationary state?

Let us call your answer for  $\rho_\alpha(t) = P_{\alpha\alpha}(t)$  to emphasize the fact that it is the probability of being in the  $\alpha$  state at time  $t' + t$ , given that it is in the  $\alpha$  state at time  $t'$ . You may wish to check that  $P_{\alpha\alpha}(0) = 1$ , and that  $P_{\alpha\alpha}(t) \rightarrow \langle \rho_\alpha \rangle$  as  $t \rightarrow \infty$ .

(c) Correlation function. Let  $R(t)$  be the resistance as a function of time, hopping between  $R_\alpha$  and  $R_\beta$ , as shown in Fig. 10.16, and let  $\bar{R}$  be the time average of the resistance. Write a formula for the connected correlation function  $C(t) = \langle (R(t') - \bar{R})(R(t'+t) - \bar{R}) \rangle$  in terms of  $P_{\alpha\alpha}(t)$ . You need not substitute in your answer for  $P_{\alpha\alpha}$  from part (b). (Hint: What is  $\langle (R(t') - R_\beta)(R(t'+t) - R_\beta) \rangle$  in terms of  $P_{\alpha\alpha}(t)$ ? What is it in terms of  $C(t)$ ?)

<sup>42</sup>Adapted from exam question by Bert Halperin, Harvard University, 1976.

<sup>43</sup>Here  $g$  is the gyromagnetic ratio for the spin, and  $\mu_B = e\hbar/2m_e$  is the Bohr magneton.

<sup>44</sup>More specifically, the right eigenvectors  $M \cdot \vec{\rho}_\lambda = \lambda \vec{\rho}_\lambda$ .



You may wish to check that your  $C(t) \rightarrow 0$  as  $t \rightarrow \infty$ , and that  $C(0) = \langle \rho_\alpha \rangle (R_\alpha - \bar{R})^2 + \langle \rho_\beta \rangle (R_\beta - \bar{R})^2$ .

Nanojunctions, especially at higher temperatures, often show more than two metastable states in the experimental bandwidth.<sup>45</sup> Usually these form independent two-level fluctuators (atomic rearrangements too far apart to interact substantially), but sometimes more complex behavior is seen. Figure 10.17 shows three resistance states, which we label  $\alpha$ ,  $\beta$ , and  $\gamma$  from lowest resistance to highest. We notice from Fig. 10.17 that the rates  $P_{\gamma\beta}$  and  $P_{\beta\gamma}$  are the highest, followed by the rates  $P_{\alpha\gamma}$  and  $P_{\gamma\alpha}$ . There are no transitions seen going between states  $\alpha$  and  $\beta$ .

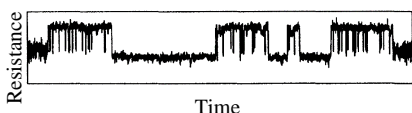


Fig. 10.17 Telegraph noise with three metastable states, from [108].

There is a large current flowing through the nanojunction, allowing the resistance to be measured. Whether these transitions are equilibrium fluctuations, perhaps with a field-dependent effective temperature, or whether they are non-equilibrium transitions mostly induced by the external current, could be tested if these last two rates could be measured. If detailed balance is violated, the system is out of equilibrium.

(d) Detailed balance. Assuming that the system satisfies detailed balance, what is the ratio between the two unmeasured rates  $P_{\alpha\beta}$  and  $P_{\beta\alpha}$  in terms of the other four rates? (Hint: See Exercise 8.5.)

(10.6) **Fluctuation-dissipation: Ising.** (Condensed matter) ③

This exercise again needs a simulation of the Ising model; you can use one we provide in the computer exercises portion of the text web site [129].

Let us consider the Ising Hamiltonian in a time-

dependent external field  $H(t)$ ,

$$\mathcal{H} = -J \sum_{\langle ij \rangle} S_i S_j - H(t) \sum_i S_i, \quad (10.91)$$

and look at the fluctuations and response of the time-dependent magnetization  $M(t) = \sum_i S_i(t)$ . The Ising model simulation should output both the time-dependent magnetization per spin  $m(t) = (1/N) \sum_i S_i$  and the time-time correlation function of the magnetization per spin,

$$c(t) = \left\langle (m(0) - \langle m \rangle_{\text{eq}})(m(t) - \langle m \rangle_{\text{eq}}) \right\rangle_{\text{ev}}. \quad (10.92)$$

We will be working above  $T_c$ , so  $\langle m \rangle_{\text{eq}} = 0$ .<sup>46</sup> The time-time correlation function will start non-zero, and should die to zero over time. Suppose we start with a non-zero small external field, and turn it off at  $t = 0$ , so  $H(t) = H_0 \Theta(-t)$ .<sup>47</sup> The magnetization  $m(t)$  will be non-zero at  $t = 0$ , but will decrease to zero over time. By the Onsager regression hypothesis,  $m(t)$  and  $c(t)$  should decay with the same law.

Run the Ising model, changing the size to  $200 \times 200$ . Equilibrate at  $T = 3$  and  $H = 0$ , then do a good measurement of the time-time autocorrelation function and store the resulting graph. (Rescale it to focus on the short times before it equilibrates.) Now equilibrate at  $T = 3$ ,  $H = 0.05$ , set  $H = 0$ , and run for a short time, measuring  $m(t)$ .

(a) Does the shape and the time scale of the magnetization decay look the same as that of the autocorrelation function? Measure  $c(0)$  and  $m(0)$  and deduce the system-scale  $C(0)$  and  $M(0)$ .

*Response functions and the fluctuation-dissipation theorem.* The response function  $\chi(t)$  gives the change in magnetization due to an infinitesimal impulse in the external field  $H$ . By superposition, we can use  $\chi(t)$  to generate the linear response to any external perturbation. If we impose a small time-dependent external field  $H(t)$ , the average magnetization is

$$M(t) - \langle M \rangle_{\text{eq}} = \int_{-\infty}^t dt' \chi(t-t') H(t'), \quad (10.93)$$

where  $\langle M \rangle_{\text{eq}}$  is the equilibrium magnetization

bandwidth if it fluctuates either too fast or too slowly to measure with the experimental set-up.

<sup>46</sup>Note that the formulæ in the text are in terms of the total magnetization  $M = Nm$  and its correlation function  $C = N^2 c$ .

<sup>47</sup>Here  $\Theta$  is the Heaviside function:  $\Theta(t) = 0$  for  $t < 0$ , and  $\Theta(t) = 1$  for  $t > 0$ .

without the extra field  $H(t)$  (zero for us, above  $T_c$ ).

(b) Using eqn 10.93, write  $M(t)$  for the step down  $H(t) = H_0\Theta(-t)$ , in terms of  $\chi(t)$ .

The fluctuation-dissipation theorem states

$$\chi(t) = -\beta dC(t)/dt, \quad (10.94)$$

where  $C(t) = \langle (M(0) - \langle M \rangle_{\text{eq}})(M(t) - \langle M \rangle_{\text{eq}}) \rangle_{\text{ev}}$ .

(c) Use eqn 10.94 and your answer to part (b) to predict the relationship between the demagnetization  $M(t)$  and the correlation  $C(t)$  you measured in part (a). How does your analytical ratio compare with the  $t = 0$  ratio you noted down in part (a)?

(10.7) **Noise and Langevin equations.** ③

We have never explicitly discussed how the energy removed from a system by damping is returned to the system to maintain thermal equilibrium. This energy input is through the thermal fluctuation noise introduced through the coupling to the heat bath. In this exercise we will derive a *Langevin equation* incorporating both noise and dissipation (see also [27, section 8.8]). We start with a system with phase-space coordinates  $\mathbb{P}, \mathbb{Q}$  and an internal potential energy  $V(\mathbb{Q})$ , coupled linearly to a heat bath through some coupling term  $\mathbb{Q} \cdot \mathbb{F}$ :

$$\mathcal{H} = \frac{\mathbb{P}^2}{2m} + V(\mathbb{Q}) + \mathcal{H}_{\text{bath}}(y_1, y_2, y_3, \dots) - \mathbb{Q} \cdot \mathbb{F}(y_1, \dots). \quad (10.95)$$

In the absence of the coupling to our system, assume that the bath would contribute an external noise  $\mathbb{F}_b(t)$  with mean zero. In the presence of the coupling to the system, the mean value of the force will develop a non-zero expectation value

$$\langle \mathbb{F}(t) \rangle = \int_{-\infty}^t dt' \chi_b(t-t') \mathbb{Q}(t'), \quad (10.96)$$

where  $\chi_b(t-t')$  is the susceptibility of the bath to the motion of the system  $\mathbb{Q}(t)$ . Our system then has an equation of motion with a random noise  $\mathbb{F}$  and a time-retarded interaction due to  $\chi_b$ :

$$m\ddot{\mathbb{Q}} = -\frac{\partial V}{\partial \mathbb{Q}} + \mathbb{F}_b + \int_{-\infty}^t dt' \chi_b(t-t') \mathbb{Q}(t'). \quad (10.97)$$

We can write this susceptibility in terms of the correlation function of the noise in the absence of the system:

$$C_b(t-t') = \langle \mathbb{F}_b(t) \mathbb{F}_b(t') \rangle \quad (10.98)$$

using the fluctuation-dissipation theorem

$$\chi_b(t-t') = -\beta \frac{\partial C_b}{\partial t}, \quad t > t'. \quad (10.99)$$

(a) Integrating by parts and keeping the boundary terms, show that the equation of motion has the form

$$m\ddot{\mathbb{Q}} = -\frac{\partial \bar{V}}{\partial \mathbb{Q}} + \mathbb{F}_b - \beta \int_{-\infty}^t dt' C_b(t-t') \dot{\mathbb{Q}}(t'). \quad (10.100)$$

What is the ‘potential of mean force’  $\bar{V}$ , in terms of  $V$  and  $C_b$ ?

(b) If the correlations in the bath are short-lived compared to the time scales of the system, we can approximate  $\dot{\mathbb{Q}}(t') \approx \dot{\mathbb{Q}}(t)$  in eqn 10.100, leading to a viscous friction force  $-\gamma\dot{\mathbb{Q}}$ . What is the formula for  $\gamma$ ? Conversely, for a model system with a perfect viscous friction law  $-\gamma\dot{\mathbb{Q}}$  at temperature  $T$ , argue that the noise must be white  $C_b(t-t') \propto \delta(t-t')$ . What is the coefficient of the  $\delta$ -function? Notice that viscous friction implies a memoryless, Markovian heat bath, and vice versa.

Langevin equations are useful both in analytic calculations, and as one method for maintaining a constant temperature in molecular dynamics simulations.

(10.8) **Magnetic dynamics.** (Condensed matter) ③

A one-dimensional classical magnet above its critical point is described by a free energy density

$$\mathcal{F}[M] = (C/2)(\nabla M)^2 + (B/2)M^2, \quad (10.101)$$

where  $M(x)$  is the variation of the magnetization with position along the single coordinate  $x$ . The average magnetization is zero, and the total free energy of the configuration  $M(x)$  is  $F[M] = \int \mathcal{F}[M] dx$ .

The methods we used to find the correlation functions and susceptibilities for the diffusion equation can be applied with small modifications to this (mathematically more challenging) magnetic system.

Assume for simplicity that the magnet is of length  $L$ , and that it has periodic boundary conditions. We can then write  $M(x)$  in a Fourier series (eqn A.4)

$$M(x) = \sum_{n=-\infty}^{\infty} \tilde{M}_n \exp(ik_n x), \quad (10.102)$$

with  $k_n = 2\pi n/L$  and (eqn A.3)

$$\widetilde{M}_n = (1/L) \int_0^L M(x) \exp(-ik_n x). \quad (10.103)$$

As always, for linear systems with translation invariance (Section A.4) the free energy  $F[M]$  decomposes into independent terms, one for each  $k_n$ .<sup>48</sup>

(a) Calculate this decomposition of  $F$ : show that each term is quadratic. (Hint: The only subtle case is  $\widetilde{M}_n^2$ ; break it into real and imaginary parts.) What is  $\langle |\widetilde{M}_n|^2 \rangle_{\text{eq}}$ , by equipartition? Argue that

$$\langle \widetilde{M}_{-m} \widetilde{M}_n \rangle_{\text{eq}} = \frac{k_B T}{L(Ck_n^2 + B)} \delta_{mn}. \quad (10.104)$$

(b) Calculate the equilibrium equal-time correlation function for the magnetization,  $C(x, 0) = \langle M(x, 0)M(0, 0) \rangle_{\text{eq}}$ . (First, find the formula for the magnet of length  $L$ , in terms of a sum over  $n$ . Then convert the sum to an integral:  $\int dk \leftrightarrow \sum_k \delta k = 2\pi/L \sum_k$ .) You will want to know the integral

$$\int_{-\infty}^{\infty} e^{iuv} / (1 + a^2 u^2) du = (\pi/a) \exp(-|v|/a). \quad (10.105)$$

Assume the magnetic order parameter is not conserved, and is overdamped, so the time derivative of  $[M]_{M_i}$  is given by a constant  $\eta$  times the variational derivative of the free energy:

$$\frac{\partial [M]_{M_i}}{\partial t} = -\eta \frac{\delta \mathcal{F}}{\delta M}. \quad (10.106)$$

$M$  evolves in the direction of the total force on it.<sup>49</sup> The term  $\delta \mathcal{F} / \delta M$  is the *variational derivative*.<sup>50</sup>

$$\begin{aligned} \delta F &= F[M + \delta M] - F[M] \\ &= \int (\mathcal{F}[M + \delta M] - \mathcal{F}[M]) dx \\ &= \int (\delta \mathcal{F} / \delta M) \delta M dx. \end{aligned} \quad (10.107)$$

(c) Calculate  $\delta \mathcal{F} / \delta M$ . As in the derivation of the Euler–Lagrange equations [89, section 12.1] you will need to integrate one term by parts to factor out the  $\delta M$ .

(d) From your answer to part (c), calculate the Green’s function for  $G(x, t)$  for  $[M]_{M_i}$ , giving the time evolution of a  $\delta$ -function initial condition  $M_i(x) = M(x, 0) = G(x, 0) = \delta(x)$ . (Hint: You can solve this with Fourier transforms.)

The Onsager regression hypothesis tells us that the time evolution of a spontaneous fluctuation (like those giving  $C(x, 0)$  in part (b)) is given by the same formula as the evolution of an imposed initial condition (given by the Green’s function of part (d)):

$$\begin{aligned} C(x, t) &= \langle M(x, t)M(0, 0) \rangle_{\text{ev}} \\ &= \langle [M(x, t)]_{M_i} M(0, 0) \rangle_{\text{eq}} \\ &= \left\langle \int_{-\infty}^{\infty} M(x', 0)G(x - x', t) dx' M(0, 0) \right\rangle_{\text{eq}} \\ &= \int_{-\infty}^{\infty} C(x', 0)G(x - x', t) dx'. \end{aligned} \quad (10.108)$$

(e) Using the Onsager regression hypothesis calculate the space–time correlation function  $C(x, t) = \langle M(x, t)M(0, 0) \rangle_{\text{ev}}$ . (This part is a challenge; your answer will involve the error function.) If it is convenient, plot it for short times and for long times; does it look like  $\exp(-|y|)$  in one limit and  $\exp(-y^2)$  in another?

The fluctuation-dissipation theorem can be used to relate the susceptibility  $\chi(x, t)$  to the time-dependent impulse to the correlation function  $C(x, t)$  (eqn 10.60). Let  $\chi(x, t)$  represent the usual response of  $M$  to an external field  $H(x', t')$  (eqn 10.29) with the interaction energy being given by  $\int M(x)H(x) dx$ .

(f) Calculate the susceptibility  $\chi(x, t)$  from  $C(x, t)$ . Start by giving the abstract formula, and then substitute in your answer from part (e).

(10.9) **Quasiparticle poles and Goldstone’s theorem.** ③

Sound waves are the fundamental excitations (or Goldstone modes) associated with *translational symmetry*. If a system is invariant under shifts sideways by a constant displacement  $u$ , they must have low-frequency excitations associated with long-wavelength displacement fields  $u(x, t)$  (Section 9.3).

<sup>48</sup>Notice that this independence implies that in equilibrium the phases of the different modes are uncorrelated.

<sup>49</sup>Remember that the average  $[M]_{M_i}$  is over all future evolutions given the initial condition  $M_i(x) = M(x, 0)$ .

<sup>50</sup>This formula is analogous to taking the gradient of a scalar function of a vector,  $f(\vec{y} + \vec{\delta}) - f(\vec{y}) \approx \nabla f \cdot \vec{\delta}$ , with the dot product for vector gradient replaced by the integral over  $x$  for derivative in function space.

Sound waves have a slight damping or dissipation, called *ultrasonic attenuation*. If our system is also Galilean invariant<sup>51</sup> this dissipation becomes small as the wavelength goes to infinity. We illustrate this fact by calculating this dissipation for a particular model of sound propagation. Let our material have speed of sound  $c$  and density  $\rho$ . Suppose we subject it to an external force  $f(x, t)$ . We model the dissipation of energy into heat using *Kelvin damping*, with damping constant  $d^2$ :

$$\frac{\partial^2 u}{\partial t^2} = c^2 \frac{\partial^2 u}{\partial x^2} + d^2 \frac{\partial}{\partial t} \frac{\partial^2 u}{\partial x^2} + \frac{f(x, t)}{\rho}. \quad (10.109)$$

We noted in Exercise 9.6 that Kelvin damping is the dissipative term with fewest derivatives allowed by Galilean invariance.

In the absence of dissipation and forcing  $d = 0 = f(x, t)$ , the wave equation has plane-wave solutions  $u(x, t) = \exp(i(kx - \omega_k t))$ , with the dispersion relation  $\omega_k = \pm ck$ . The damping causes these plane-wave solutions to decay with time, giving the frequency an imaginary part  $\omega_k \rightarrow \omega_k - i\Gamma$ . Define the *quality factor*  $Q_k$  to be  $2\pi$  times the number of periods of oscillation needed for the energy in the wave (proportional to  $u^2$ ) to decay by a factor of  $1/e$ .

(a) Show that eqn 10.109 with no forcing ( $f = 0$ ) has solutions in the form of damped plane waves,

$$\begin{aligned} u(x, t) &= \exp(i(kx - \omega_k t)) \exp(-\Gamma_k t) \\ &= \exp(i(kx - \Omega_k t)), \end{aligned} \quad (10.110)$$

with complex frequency  $\Omega_k = \omega_k - i\Gamma_k$ . Solve for  $\Omega_k$  (quadratic formula). What is the new dispersion relation  $\omega_k$ ? What is the damping  $\Gamma_k$ ? Show at long wavelengths that the frequency  $\omega_k \approx \pm ck$ . With what power of  $k$  does the quality factor diverge as  $k \rightarrow 0$ ? Thus the lower the frequency, the smaller the damping per oscillation. The Goldstone modes become dissipationless as  $\omega \rightarrow 0$ .

(b) At what wavelength does the real part of the frequency  $\omega_k$  vanish? (This is where the sound wave begins to be overdamped; at shorter wavelengths displacements relax diffusively, without oscillations.)

This trick, looking for damped waves as solutions, is rather special to linear equations. A much more general approach is to study the susceptibility to external perturbations. If we force the undamped system with a forcing  $f(x, t) = \cos(kx) \cos(ckt)$  that matches the wavevector and frequency  $\omega = ck$  of one of the phonons, the amplitude of that mode of vibration will grow without limit; the susceptibility diverges. Let us try it with damping.

(c) What is the susceptibility  $\tilde{\chi}(k, \omega)$  for our damped system (eqn 10.109)? (Hint: Change to Fourier variables  $k$  and  $\omega$ , and the exercise should reduce to simple algebra.) Check that your answer without dissipation ( $d = 0$ ) has poles<sup>52</sup> at  $\omega_k = \pm ck$  for each wavevector  $k$ ; the susceptibility diverges when excited on resonance. Check that these poles move to  $\Omega_k = \omega_k - i\Gamma_k$  (from part (a)) when dissipation is included.

(d) Check that the poles in the susceptibility are all in the lower half-plane, as required by causality (Section 10.9).

Neutron scattering can be used to measure the Fourier transform of the correlation function,  $\tilde{C}(k, \omega)$  in a material. Suppose in our material  $c = 1000$  m/s,  $d = 10^{-3}$  m/s<sup>1/2</sup>,  $\rho = 1$  g/cm<sup>3</sup>, and  $T = 300$  K; for your convenience,  $k_B = 1.3807 \times 10^{-23}$  J/K.

(e) Use the fluctuation-dissipation theorem

$$\chi''(\mathbf{k}, \omega) = \frac{\beta\omega}{2} \tilde{C}(\mathbf{k}, \omega) \quad (10.111)$$

(see eqn 10.65) to calculate  $\tilde{C}(k, \omega)$ , the correlation function for our material. Plot  $\tilde{C}(k, \omega)$  at  $\omega = 10^8$  (about 16 MHz), for  $k$  from zero to  $2 \times 10^5$ . Does it appear difficult to estimate the dispersion relation  $\omega_k$  from the correlation function?

In strongly-interacting systems, the elementary excitations are *quasiparticles*: dressed electrons, photons, or vibrational modes which are not many-body eigenstates because they eventually decay (note 23 on p. 144). These quasiparticles are defined in terms of poles in the propagator or quantum Green's function, closely related to our classical correlation function  $\tilde{C}(k, \omega)$ .

<sup>51</sup>A Galilean transformation is a boost by a velocity  $v$ :  $u(x, t) \rightarrow u(x, t) + vt$  (a non-relativistic Lorentz boost). A Galilean-invariant system does not notice whether it is moving with a steady velocity.

<sup>52</sup>A function  $\psi(z)$  has a pole at  $z_0$  if it diverges at  $z_0$  like a constant times  $z - z_0$ . The poles are easy to find if  $\psi$  is a ratio of two functions which themselves do not go to infinity; the poles are the zeros of the denominator.

# Abrupt phase transitions

# 11

Most phase transitions are abrupt. At the transition, the system has discontinuities in most physical properties; the density, compressibility, viscosity, specific heat, dielectric constant, and thermal conductivity all jump to new values. Furthermore, in most cases these transitions happen with no precursors, no hint that a change is about to occur; pure water does not first turn to slush and then to ice,<sup>1</sup> and water vapor at 101 °C has no little droplets of water inside.<sup>2</sup>

In Section 11.1, we explore the phase diagrams and free energies near abrupt phase transitions. In Section 11.2, we learn about the *Maxwell construction*, used to determine the coexistence point between two phases. In Section 11.3, we calculate how quickly the new phase nucleates at an abrupt transition. Finally, in Section 11.4, we introduce three kinds of microstructures associated with abrupt transitions—*coarsening*, *martensites*, and *dendrites*.

## 11.1 Stable and metastable phases

Water remains liquid as it is cooled, until at 0 °C it abruptly freezes into ice. Water remains liquid as it is heated, until at 100 °C it abruptly turns to vapor.

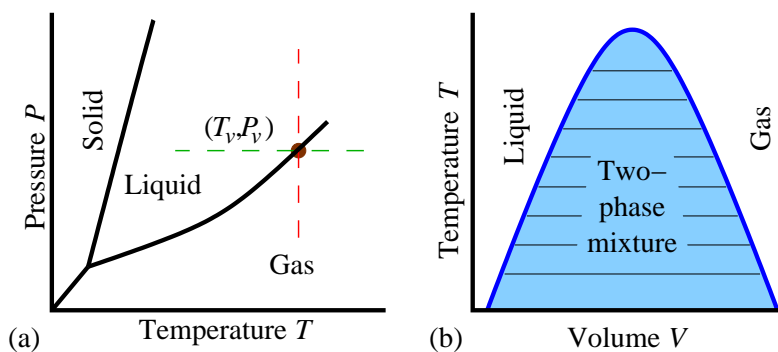
There is nothing abrupt, however, in boiling away a pan of water.<sup>3</sup> This is because one is not controlling the temperature directly, but rather is adding energy at a constant rate. Consider an insulated, flexible container of H<sub>2</sub>O at fixed pressure, as we slowly add energy to it. When

11.1 Stable and metastable phases	241
11.2 Maxwell construction	243
11.3 Nucleation: critical droplet theory	244
11.4 Morphology of abrupt transitions	246

<sup>1</sup>Water with impurities like salt or sugar will form slush. The slush is ice that is mostly pure H<sub>2</sub>O surrounded by rather salty water. The salt lowers the freezing point; as the ice freezes it expels the salt, lowering the freezing point of the remaining liquid.

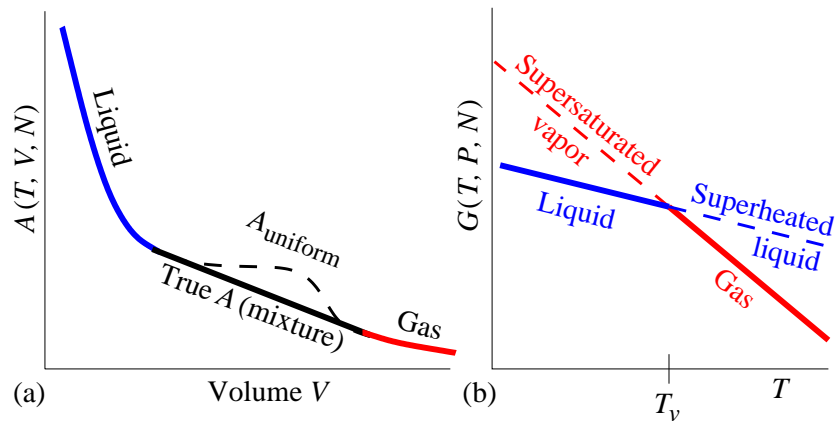
<sup>2</sup>More precisely, there are only exponentially rare microscopic droplet fluctuations, which will be important for nucleation, see Section 11.3.

<sup>3</sup>The *latent heat* is the change in enthalpy  $E + PV$  at a phase transition. For boiling water it is 2500 J/g = 600 calories/g. Hence, at a constant energy input from your stove, it takes six times as long to boil away the water as it takes to raise it from freezing to boiling ((1 cal/g °C) × 100 °C).



**Fig. 11.1**  $P$ - $T$  and  $T$ - $V$  phase diagrams for a typical material. (a) The liquid-gas line gives the vapor pressure  $P_v(T)$  or the boiling point  $T_v(P)$ . For H<sub>2</sub>O the solid-liquid boundary would slope up and to the left, since ice is (atypically) less dense than water. (b)  $T$ - $V$  liquid-gas phase diagram at fixed  $N$ , showing the two-phase region. (See also Figs 8.8 and 12.6(a)). The horizontal tie-lines represent phase separation; a system in this region will separate into domains of liquid and gas at the two endpoints of the corresponding tie-line. A  $P$ - $V$  phase diagram would look similar.

**Fig. 11.2 Stable and metastable states.** (a) Helmholtz free energy as a function of volume. The dashed line represents metastable and unstable states (see Fig. 11.3(a)). In this range of volumes, the equilibrium state is non-uniform, a mixture of liquid and gas as shown by the dark straight line. (A mixture  $\lambda N$  of stable gas and  $(1-\lambda)N$  stable liquid will interpolate linearly on this plot:  $V = \lambda V_{\text{gas}}^{\text{uniform}} + (1-\lambda)V_{\text{liq}}^{\text{uniform}}$ , and  $A = \lambda A_{\text{gas}} + (1-\lambda)A_{\text{liq}}$  plus an interfacial free energy which is negligible for large systems.) (b) Gibbs free energy for the liquid and gas phases along an isobar (constant pressure, horizontal dashed line in Fig. 11.1(a)). The phase transition occurs when the two curves cross.



the system first reaches the liquid–gas transition, a small bubble of gas will form at the top; this bubble will gradually grow, inflating and filling the container over a range of energies. The transition from liquid to gas at fixed pressure passes through an intermediate *two-phase region*; the temperature of the system stays constant until the last liquid is gone. Alternatively, one can do the experiment fixing the temperature and varying the volume  $V$  of the container. The resulting phase diagram is shown in Fig. 11.1(b); the two-phase region results here from minimizing the Helmholtz free energy  $A(T, V, N)$  as discussed in Fig. 11.2(a).<sup>4</sup>

To avoid these two-phase mixtures, we choose to work in the variables  $P$  and  $T$ , so we use the Gibbs free energy<sup>5</sup>

$$G(T, P, N) = E - TS + PV. \quad (11.1)$$

As usual (Section 6.5), whichever state minimizes  $G$  wins.<sup>6</sup> The Euler relation  $E = TS - PV + \mu N$  tells us that  $G = \mu N$  (Exercise 6.9). So, the state with the lower chemical potential will be favored, and the phase transition will occur when  $\mu_{\text{liq}} = \mu_{\text{gas}}$ . That makes sense; at a liquid–vapor boundary, one can exchange energy, volume, or particles. Energy will exchange until the temperatures are equal, volume will exchange until the pressures are equal, and then particles will move from liquid to gas until the chemical potentials are equal.

Remembering the shorthand thermodynamic relation  $dE = T dS - P dV + \mu dN$ , and applying it to eqn 11.1, we find  $dG = -S dT + V dP + \mu dN$ . Varying the temperature at fixed pressure and number of particles, we thus learn that

$$\left. \frac{\partial G}{\partial T} \right|_{P, N} = -S. \quad (11.2)$$

Figure 11.2(b) shows the Gibbs free energy versus temperature for the liquid and gas. At the phase boundary, the two free energies agree.

<sup>4</sup>The straightness of the free energy in the two phase region says that the pressure  $P = -(\partial A / \partial V)|_{T, N}$  is constant as the volume increases and the liquid turns to gas, just as the temperature stays constant as the liquid boils at fixed pressure. The free energy of a stable uniform state must always lie below any mixed state with the same total volume, number, and energy: equilibrium free energies are *convex functions*.

<sup>5</sup>We could also avoid the two-phase mixtures by using the grand free energy,  $\Phi(T, V, \mu) = E - TS - \mu N$ . The grand partition function allows the total number of particles to vary, so when the liquid turns to gas the molecules in the extra volume are simply removed.

<sup>6</sup>Minimizing  $G$  for the system maximizes the entropy for the Universe as a whole (the system plus the bath with which it exchanges energy and volume).

The difference in slopes of the two lines is given by the difference in entropies between the liquid and the gas (eqn 11.2). The thermodynamic definition of the entropy  $S = dQ/T$  (Section 5.1) tells us that the entropy difference is given by the latent heat per particle  $L$  times the number of particles  $N$  over the transition temperature  $T_v$ ,

$$\Delta S = LN/T_v. \quad (11.3)$$

The fact that the Gibbs free energy has a kink at the phase transition reflects the jump in the entropy between liquid and gas; abrupt phase transitions will have jumps in the first derivatives of their free energies. This led early workers in the field to term these transitions *first-order transitions*.<sup>7</sup>

Notice that we continue to draw the free energy curves for the liquid and vapor on the ‘wrong’ sides of the phase boundary. It is a common experimental fact that one can supercool vapors significantly beyond their condensation point.<sup>8</sup> With careful experiments on clean systems, one can also significantly superheat the liquid phase. Theoretically the issue is subtle. Some theories of these transitions have well-defined metastable phases (dashed lines in Fig. 11.2(a)). However, there certainly is no *equilibrium* vapor state below  $T_v$ . More sophisticated approaches (not discussed here) give an imaginary part to the free energy density of the metastable phase.<sup>9</sup>

## 11.2 Maxwell construction

Figure 11.3(a) shows the pressure versus volume as we expand our material at constant temperature. The liquid turns metastable as the volume increases, when the pressure reaches the vapor pressure for that temperature. The gas becomes metastable at that same pressure when the volume decreases. The metastable states are well defined only near the vapor pressure, where nucleation is slow (Section 11.3) and lifetimes are reasonably large. The dashed line shows a region which is completely unstable; a mixture of molecules prepared uniformly in space in this region will spontaneously separate into finely inter-tangled networks of the two phases<sup>10</sup> (Section 11.4.1).

How did we know to draw the coexistence line at the pressure we chose in Fig. 11.3(a)? How can we find the vapor pressure at which the liquid and gas coexist at this temperature? We know from the last section that the coexistence line occurs when their Gibbs free energies agree  $G_{\text{liq}} = G_{\text{gas}}$ . Again,  $dG = -S dT + V dP + \mu dN$ , so at constant temperature and number  $(\partial G/\partial P)|_{T,N} = V$ . Hence, we know that

$$\Delta G = \int_{P_{\text{liq}}}^{P_{\text{gas}}} V(P) dP = 0. \quad (11.4)$$

Now this integral may seem zero by definition, because the limits of integration are both equal to the vapor pressure,  $P_{\text{liq}} = P_{\text{gas}} = P_v(T)$ .

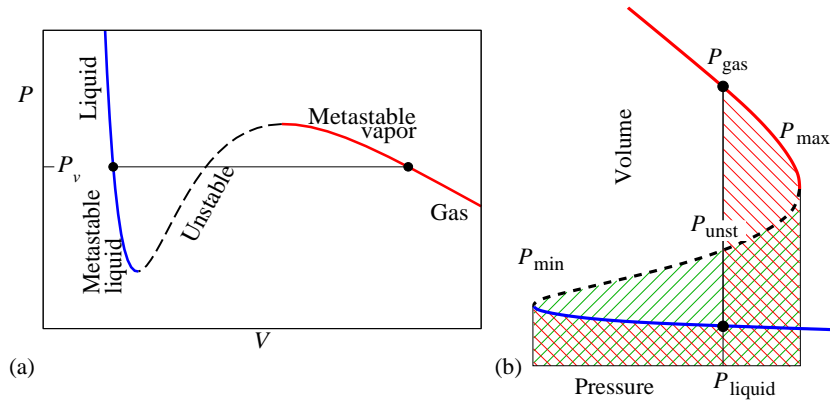
<sup>7</sup>We avoid using this term, and the analogous term *second order* for continuous phase transitions. This is not only because their origin is obscure, but also because in the latter case it is misleading: the thermodynamic functions at a continuous phase transition have power-law singularities or essential singularities, not plain discontinuities in the second derivative (Chapter 12).

<sup>8</sup>That is precisely what occurs when the relative humidity goes beyond 100%.

<sup>9</sup>Just as the lifetime of a resonance in quantum mechanics is related to the imaginary part of its energy  $E + i\hbar\Gamma$ , so similarly is the rate per unit volume of nucleation of the new phase (Section 11.3) related to the imaginary part of the free energy density. We will not explain this here, nor will we discuss the corresponding essential singularity in the free energy (but see [21, 73]).

<sup>10</sup>This spontaneous separation is termed *spinodal decomposition*. In the past, the endpoints of the dashed curve were called *spinodal points*, but there is reason to doubt that there is any clear transition between nucleation and spontaneous separation, except in mean-field theories.

**Fig. 11.3 Maxwell equal-area construction.** (a) Pressure versus volume curve along an isotherm (dashed vertical line at constant temperature in Fig. 11.1(a)). At low volumes the material is liquid; as the volume crosses into the two-phase region in Fig. 11.1(b) the liquid becomes metastable. At high volumes the gas phase is stable, and again the metastable gas phase extends into the two-phase region. The dots represent the coexistence point where the pressures and chemical potentials of the two phases are equal. (b) The Gibbs free energy difference between two points at equal pressures is given by the difference in areas scooped out in the  $P$ - $V$  curves shown (upward diagonal area minus downward diagonal area).

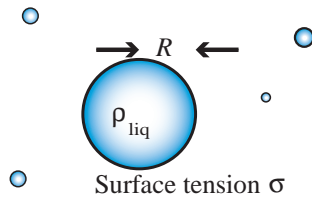


This formula instead represents the sum of four pieces (Fig. 11.3(b)):

$$\Delta G = \int_{P_{\text{liq}}}^{P_{\text{min}}} V(P) dP + \int_{P_{\text{min}}}^{P_{\text{unst}}} V(P) dP + \int_{P_{\text{unst}}}^{P_{\text{max}}} V(P) dP + \int_{P_{\text{max}}}^{P_{\text{gas}}} V(P) dP, \quad (11.5)$$

where the unstable point corresponds to the barrier top in Fig. 11.2(a) and  $P_{\text{liq}} = P_{\text{unst}} = P_{\text{gas}}$  at coexistence. Notice that the first and last terms are negative, since  $P_{\text{liq}} > P_{\text{min}}$  and  $P_{\text{max}} > P_{\text{gas}}$ . These four integrals have a nice graphical interpretation, shown in Fig. 11.3(b): the first two subtract to give the area with stripes solely up and to the right and the last two subtract to give minus the area with stripes solely down and to the right. These two areas must be equal at the vapor pressure. This is the *Maxwell equal-area construction*.<sup>11</sup>

<sup>11</sup>The Maxwell construction only makes sense, one must remember, for theories like mean-field theories where one has an unstable branch for the  $P(V)$  curve (Fig. 11.2(a)).



**Fig. 11.4 Vapor bubble.** The nucleation of a new phase happens through a rare thermal fluctuation, where a droplet of the new phase forms of sufficient size to get it over the free energy barrier of Fig. 11.5.

### 11.3 Nucleation: critical droplet theory

On a humid night, as the temperature drops, the air may become supersaturated with water vapor. How does this metastable vapor turn into drops of dew, or into the tiny water droplets that make up clouds or fog?

We have seen (Fig. 11.2(b)) that the Gibbs free energy difference between the gas and the liquid grows as the temperature decreases below  $T_v$ . We can estimate the chemical potential difference driving the formation of drops; we know  $\partial G/\partial T = -S$  (eqn 11.2), and  $\Delta S = LN/T_v$



(eqn 11.3), so if we supercool by  $\Delta T = T_v - T$ ,

$$\begin{aligned}\Delta\mu &= (G_{\text{gas}} - G_{\text{liq}})/N = \left( \frac{\partial(G_{\text{gas}} - G_{\text{liq}})}{\partial T} \Big|_{P,N} (T - T_v) \right) / N \\ &= \Delta S \Delta T / N = (LN/T_v)(\Delta T/N) = L\Delta T/T_v.\end{aligned}\quad (11.6)$$

What is the obstacle impeding the formation of the droplets? It is the *surface tension*  $\sigma$  between the liquid and the gas phase. The surface tension is the Gibbs free energy per unit area of the interface between liquid and gas. Like tension in a rope, the interface between two phases can exert a force, pulling inward to minimize its area.<sup>12</sup>

To make a large droplet you must grow it from zero radius (Fig. 11.4). Since the surface tension cost grows as the area  $A$  and the bulk free energy gain grows as the volume  $V$ , tiny droplets will cost the system more than they gain. Consider the energy of a spherical droplet of radius  $R$ . The surface Gibbs free energy is  $\sigma A$ . If the liquid has  $\rho_{\text{liq}}$  particles per unit volume, and each particle provides a Gibbs free energy gain of  $\Delta\mu = L\Delta T/T_v$ , the bulk free energy gain is  $V\rho_{\text{liq}}\Delta\mu$ . Hence

$$G_{\text{droplet}}(R) = \sigma A - V\rho_{\text{liq}}\Delta\mu = 4\pi R^2\sigma - \left(\frac{4}{3}\pi R^3\right)\rho_{\text{liq}}(L\Delta T/T_v). \quad (11.7)$$

This free energy is plotted in Fig. 11.5. Notice that at small  $R$  where surface tension dominates it rises quadratically, and at large  $R$  where the bulk chemical potential difference dominates it drops as the cube of  $R$ . The gas will stay a gas until a rare thermal fluctuation pays the free energy cost to reach the top of the barrier, making a *critical droplet*. The critical droplet radius  $R_c$  and the free energy barrier  $B$  are found by finding the maximum of  $G(R)$ :

$$\left. \frac{\partial G_{\text{droplet}}}{\partial R} \right|_{R_c} = 8\pi\sigma R_c - 4\pi\rho_{\text{liq}}(L\Delta T/T_v)R_c^2 = 0, \quad (11.8)$$

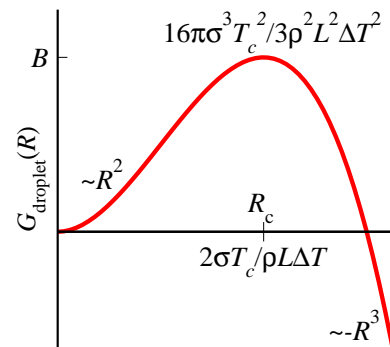
$$R_c = \frac{2\sigma T_v}{\rho_{\text{liq}}L\Delta T}, \quad (11.9)$$

$$B = \frac{16\pi\sigma^3 T_v^2}{3\rho_{\text{liq}}^2 L^2} \frac{1}{(\Delta T)^2}. \quad (11.10)$$

The probability of finding a critical droplet per unit volume is given by  $\exp(-B/k_B T)$  times a prefactor. The nucleation rate per unit volume is the net flux of droplets passing by  $R_c$ , which is the velocity over the barrier times a correction for droplets re-crossing, times this probability of being on top of the barrier.<sup>13</sup> The prefactors are important for detailed theories, but the main experimental dependence is the exponentially small probability for having a critical droplet. Our net droplet nucleation rate per unit volume  $\Gamma$  thus has the form

$$\Gamma = (\text{prefactors})e^{-B/k_B T}. \quad (11.11)$$

<sup>12</sup>How do we define the surface tension? Theoretically, we measure liquid and gas Gibbs free energies  $G_{\ell\ell}$  and  $G_{gg}$  at the coexistence point, by placing them into two tall cylindrical constant-pressure containers with surfaces that each prefer one phase over the other (e.g., in the real world wax prefers gas). We then make a new container from the top half of one and the bottom of the other, glued at their midpoint. This forces an interface to form of area  $A$  equal to the cross-section of the containers. We then measure the Gibbs free energy with the interface  $G_{\ell g}$ , and define the surface tension  $\sigma = [G_{\ell g} - \frac{1}{2}(G_{\ell\ell} + G_{gg})]/A$ . We need to do something this complicated in order to be sure to cancel out the interaction free energies with the side-walls. Note that defining the surface tension for curved interfaces away from coexistence is more subtle [71, chapter XV].



**Fig. 11.5** Free energy barrier for droplet formation.

<sup>13</sup>See Exercise 6.11 for the similar problem of calculating chemical reaction rates.

<sup>14</sup>In previous chapters, we used statistical mechanics to compute average properties of a phase, and typical (Gaussian) fluctuations near the average. Critical droplet theory (and instantons, the quantum version) allows us to calculate rare fluctuations, far in the tail of the distribution—by asking for the typical fluctuations near the transition between two phases. In Chapter 12, we will calculate rare, large events far in the tail of the distribution, by turning them into typical fluctuations for a coarse-grained system.

<sup>15</sup>The droplet nucleation rate has an essential singularity at  $T_v$ ; it is zero to all orders in perturbation theory in  $\Delta T$ . In some ways, this is why one can study the metastable states—perturbation theory naturally ignores the fact that they are unstable.

<sup>16</sup>Actually, in many clouds the temperature is low enough that ice crystals nucleate, rather than water droplets. Certain plant pathogens (*Pseudomonas syringae*) make proteins that are designed to efficiently nucleate ice crystals; the bacteria use the frost damage on the plants to invade. Humans use these proteins in snow-making machines at ski resorts.

Notice the following.<sup>14</sup>

- The critical droplet radius  $R_c \propto 1/\Delta T$ . If you undercool the gas only a tiny amount, you need a big droplet to overcome the surface tension.
- The barrier height  $B \propto 1/(\Delta T)^2$ . The energy barrier for nucleation diverges at  $T_v$ .
- The droplet nucleation rate  $\Gamma \propto \exp(-C/(\Delta T)^2)$ . It can be tiny for small undercoolings.<sup>15</sup>

The rates we have calculated are for *homogeneous nucleation*: the rate of forming the new phase in a perfectly clean system without boundaries. In practice, homogeneous nucleation rarely dominates. Because nucleation is so strongly suppressed by the surface tension, the system goes to great lengths to bypass at least part of the energy barrier. That is why dewdrops form on grass (or your windshield), rather than always forming in the air and dropping to the ground; the surface tension between water and grass is much lower than that between water and air, so a roughly hemispherical droplet can form—dividing the free energy barrier  $B$  in two. In cloud formation, nucleation occurs on small dust particles—again, lowering the interfacial area needed to get a droplet of a given curvature.<sup>16</sup>

Finally, we should mention that the nucleation of crystalline phases will not proceed with precisely spherical droplets. Because crystals have anisotropic surface tension, the maximum number of particles for a given surface energy is given not by a sphere, but by the *equilibrium crystal shape* (the same shape that a crystal will form in equilibrium at a constant number of particles, Fig. 11.6).

## 11.4 Morphology of abrupt transitions

What happens after the phase transition is nucleated (or when the undercooling is so large that the transition occurs immediately)? This question leads us into a gigantic, rich subject that mostly belongs to geology, engineering, and materials science rather than to statistical mechanics. We will give a brief introduction, with emphasis on topics where statistical mechanics is useful.

### 11.4.1 Coarsening

What do salad dressing, cast iron, and rocks have in common? *Coarsening* is crucial to all three. When you shake up oil and vinegar, they get jumbled together in small droplets. When you stop shaking, the tiny droplets merge into bigger ones, gradually making for a coarser and coarser mixture until all the oil is on the top.

Molten iron, before it is cast, has a fair percentage of carbon dissolved in it. As it cools, this dissolved carbon precipitates out (with many nuclei forming as in Section 11.3 and then growing until the carbon runs out),

staying dispersed through the iron in particles whose size and number depend on the cooling schedule. The hardness and brittleness of cast iron depends on the properties of these carbon particles, and thus depends on how the iron is cooled.

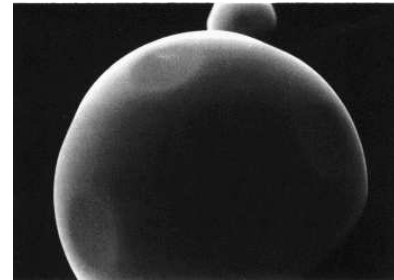
Rocks often have lots of tiny grains of different materials: quartz, alkali feldspar, and plagioclase in granite; plagioclase feldspar and calcium-rich pyroxene in basalt, . . . Different rocks have different sizes of these grains.

Rocks formed from the lava of erupting volcanoes have very fine grains; rocks deep underground cooled from magma over eons form large grains. For a particular grain to grow, the constituent atoms must diffuse through neighboring grains of other materials—a process that gets very slow as the grains get larger. Polycrystals also form from cooling single materials; different liquid regions will nucleate crystalline grains in different orientations, which then will grow and mush together. Here the grains can grow by stealing one another's molecules, rather than waiting for their brand of molecules to come from afar.

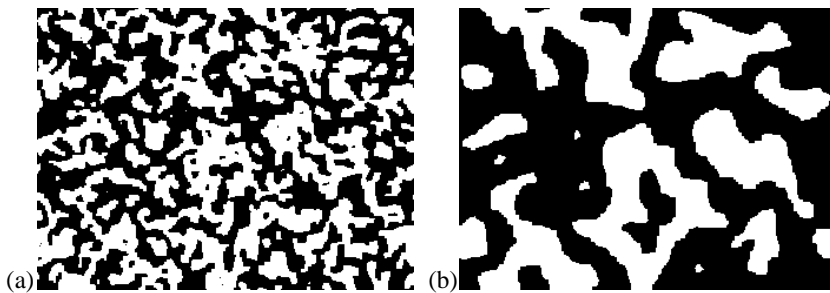
One can also see coarsening on the computer. Figure 11.7 shows two snapshots of the Ising model, quenched to zero temperature, at times differing by roughly a factor of ten. Notice that the patterns of up- and down-spins look statistically similar in the two figures, except that the overall length scale  $L(t)$  has grown larger at later times. This is the characteristic feature that underlies all theories of coarsening: the system is statistically similar to itself at a later time, except for a time-dependent length scale  $L(t)$ .

The basic results about coarsening can be derived by arguments that are almost simplistic. Consider a snapshot (Fig. 11.8) of a coarsening system. In this snapshot, most features observed have a characteristic length scale  $R \sim L(t)$ . The coarsening process involves the smaller features shrinking to zero, so as to leave behind only features on larger scales. Thus we need to understand how long it takes for spheres and protrusions on a scale  $R$  to vanish, to derive how the size  $L(t)$  of the remaining features grows with time.  $L(t)$  is the size  $R_0$  of the smallest original feature that has not yet shrunk to zero.

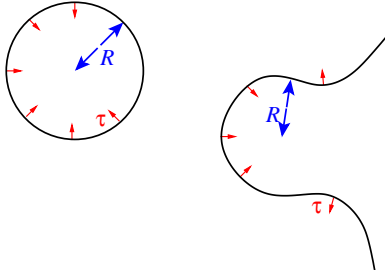
The driving force behind coarsening is surface tension: the system can lower its free energy by lowering the interfacial area between the different



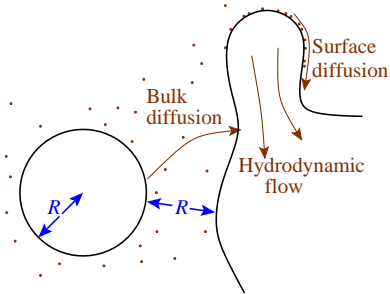
**Fig. 11.6 Equilibrium crystal shape** of lead at about  $300^\circ\text{C}$  [111, 119]. Notice the flat facets, which correspond to low-energy high-symmetry surfaces. There are three interesting statistical mechanics problems associated with these facets that we will not discuss in detail. (1) The crystalline orientations with flat facets are in a different phase than the rounded regions; they are below their *roughening transition*. (2) The equilibrium crystal shape, which minimizes the free energy, can be viewed as a Legendre transform of that free energy (the *Wulff construction*). (3) At lower temperatures, for some interactions, the entire equilibrium crystal shape can be faceted (below the *edge* and *corner rounding* transitions); we predict that the coarsening length will grow only logarithmically in time in this phase (Fig. 11.10).



**Fig. 11.7 Coarsening.** The spin configuration of the Ising model at  $T = 0$  with non-conserved dynamics, after a time of (a) roughly twenty sweeps through the lattice, and (b) roughly 200 sweeps. Notice that the characteristic morphologies look similar, except that the later picture has a length scale roughly three times larger ( $\sqrt{10} \approx 3$ ).



**Fig. 11.8 Curvature-driven interface motion.** The surface tension  $\sigma$  at the interface produces a traction (force per unit area)  $\tau = 2\sigma\kappa$  that is proportional to the local mean curvature of the surface  $\kappa$  at that point. The coarsening morphology has a characteristic length  $R$ , so it has a characteristic mean curvature  $\kappa \sim 1/R$ . For non-conserved order parameters, these forces will lead to a length scale  $L(t) \sim t^{1/2}$ .



**Fig. 11.9 Coarsening for conserved order parameter.** Differences in local mean curvature drives the growth in the case of a conserved order parameter. Atoms will diffuse from regions of high positive curvature to regions of low or negative curvature. Bulk diffusion dominates on long length scales ( $L(t) \sim t^{1/3}$ ); surface diffusion can be important when the scales are small ( $L(t) \sim t^{1/4}$ ). For liquids, hydrodynamic flow makes things more complicated [134].

domains. We will focus on the evolution of a sphere as a solvable case. The surface tension energy for a sphere of radius  $R$  is  $F_{\text{surface}} = 4\pi R^2\sigma$ , so there is an inward force per unit area, (or *traction*)  $\tau$ :

$$\tau = \frac{\partial F_{\text{surface}}}{\partial R} / (4\pi R^2) = 2\sigma/R. \tag{11.12}$$

A general surface has two radii of curvature  $R_1$  and  $R_2$  which can be positive or negative; the traction  $\tau$  is perpendicular to the surface and given by the same formula 11.12 with  $1/R$  replaced with the mean curvature  $\frac{1}{2} [1/R_1 + 1/R_2]$ .

There are two broad classes of coarsening problems: ones with *conserved* and *non-conserved* order parameters. Oil and vinegar, cast iron, and granite have conserved order parameters; to grow a domain one must pull molecules through the other materials. The single-component polycrystals and the Ising model shown in Fig. 11.7 are non-conserved; spins are free to flip from one orientation to the other, and molecules are free to shift from one grain orientation to another.

For a non-conserved order parameter, the interface will generally move with a velocity proportional to the traction and an interface mobility  $\eta$ :

$$\frac{dR}{dt} = -\eta\tau = -\eta\frac{2\sigma}{R}. \tag{11.13}$$

We can solve for the time  $t_f$  it takes for the sphere to disappear, and hence find out how  $L(t)$  grows for the non-conserved case:

$$\begin{aligned} \int_{R_0}^0 R dR &= \int_0^{t_f} -2\sigma\eta dt, \\ R_0^2/2 &= 2\sigma\eta t_f, \\ L(t) \sim R_0 &= \sqrt{4\sigma\eta t} \propto \sqrt{t}. \end{aligned} \tag{11.14}$$

More complex geometries with protrusions and necks and such are not possible to solve explicitly, but in general features with a length scale  $R$  evolve on a time scale  $t \propto R^2$ , so the typical length scales grow as  $L(t) \sim t^\beta$  with  $\beta = 1/2$ .

The argument for the case of a conserved order parameter is quite similar in spirit (Fig. 11.9). Here the curvature sets up a gradient in the chemical potential  $\partial\mu/\partial x$  which causes molecules to diffuse from regions of high positive curvature to regions of low or negative curvature. The velocity of a particle will be given by the particle mobility  $\gamma = D/k_B T$  (Einstein’s relation) times the gradient of the chemical potential,

$$v = \gamma\nabla\mu \Rightarrow J = \rho v = \rho\gamma\nabla\mu \tag{11.15}$$

where  $J$  is the current per unit area and  $\rho$  is the particle density. The chemical potential change for moving a molecule from our sphere of radius  $R$  to some flat interface is just the free energy change for removing one particle; since the number of particles in our sphere is  $N = \frac{4}{3}\pi R^3\rho$ ,

$$\Delta\mu = \frac{dF_{\text{surface}}}{dR} / \frac{dN}{dR} = (8\pi\sigma R)/(4\pi R^2\rho) = \frac{2\sigma}{R\rho}. \tag{11.16}$$

The distance  $\Delta R$  from the surface of our sphere to another flatter surface of the same phase is (by our assumption of only one characteristic length scale) also of order  $R$ , so

$$J \sim \rho\gamma \frac{\Delta\mu}{\Delta R} \sim \frac{2\gamma\sigma}{R^2}. \quad (11.17)$$

The rate of change of volume of the droplet is number flux per unit area  $J$  times the surface area, divided by the number per unit volume  $\rho$ :

$$\begin{aligned} \frac{dV_{\text{droplet}}}{dt} &= \frac{4}{3}\pi \left( 3R^2 \frac{dR}{dt} \right) \\ &= - \frac{A_{\text{droplet}} J}{\rho} = -(4\pi R^2) \frac{2\gamma\sigma}{\rho R^2} = - \frac{8\pi\gamma\sigma}{\rho}, \\ \frac{dR}{dt} &= - \frac{2\gamma\sigma}{\rho} \frac{1}{R^2}, \\ \int_{R_0}^0 R^2 dR &= \int_0^{t_f} - \frac{2\gamma\sigma}{\rho} dt, \\ \frac{R_0^3}{3} &= \frac{2\gamma\sigma}{\rho} t_f, \end{aligned} \quad (11.18)$$

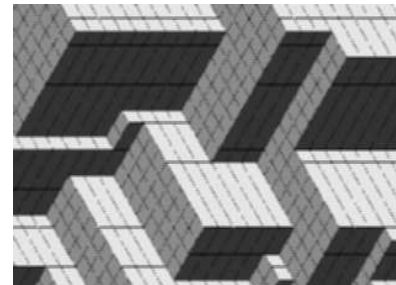
and so

$$L(t) \sim R_0 = \left( \frac{6\gamma\sigma}{\rho} t \right)^{1/3} \propto t^{1/3}. \quad (11.19)$$

This crude calculation—almost dimensional analysis—leads us to the correct conclusion that conserved order parameters should coarsen with  $L(t) \sim t^\beta$  with  $\beta = 1/3$ , if bulk diffusion dominates the transport.

The subject of coarsening has many further wrinkles.

- **Surface diffusion.** Often the surface diffusion rate is much higher than the bulk diffusion rate: the activation energy to hop across a surface is much lower than to remove a molecule completely. The current in surface diffusion goes as  $J$  times a perimeter (single power of  $R$ ) instead of  $JA$ ; repeating the analysis above gives  $L(t) \sim t^{1/4}$ . In principle, surface diffusion will always be less important than bulk diffusion as  $t \rightarrow \infty$ , but often it will dominate in the experimental range of interest.
- **Hydrodynamics.** In fluids, there are other important mechanisms for coarsening. For example, in binary liquid mixtures (oil and water) near 50/50, the two phases form continuous interpenetrating networks. Different regions of the network can have different curvatures and pressures, leading to coarsening via hydrodynamic flow [134].
- **Glassy logarithmic coarsening.** A hidden assumption in much of the coarsening theory is that the barriers to rearrangements involve only a few degrees of freedom. If instead you need to remove a whole layer at a time to reach a lower free energy, the dynamics may slow down dramatically as the sizes of the layers grow. This is precisely what happens in the three-dimensional Ising model with antiferromagnetic next-neighbor bonds mentioned above (Fig. 11.10, [132]). The



**Fig. 11.10 Logarithmic growth of an interface.** A simplified model of an interface perpendicular to a body diagonal in a frustrated next-neighbor Ising model with barriers to coarsening that diverge with length [132]. Notice that the interface is lowering its energy by poking out into facets along the cubic directions (a kind of facet coarsening). This process gets much slower as the faces get longer, because the energy barrier needed to flip a face grows linearly with its length. This slow-down happens below the *corner rounding transition* described in the caption to Fig. 11.6.



**Fig. 11.11 Martensite.** A particularly nice example of a martensitic structure, from Chu [30]. The light and dark stripes represent two different martensitic variants—that is, the crystal going through the phase transition can stretch in different directions, and the two colors indicate that the local lattice is stretching along two different axes. The tilted square region occupying most of the photograph could not change its overall shape without putting incompatible strains on the neighboring domains. By making this striped pattern, or *laminate*, the martensite can form an average of the different stretching directions that gives zero net strain.

<sup>17</sup>Steel thus has both the complications of carbon particle coarsening and martensitic domain structure, both of which are important for its structural properties and both of which depend in detail on the heating and beating it undergoes during its manufacture.

<sup>18</sup>The pathological functions you find in real analysis—continuous but nowhere differentiable functions—are practical tools for studying martensites.

energy barrier needed to flip a layer of spins grows proportionally to  $L$ , leading to a logarithmic growth law  $L(t) \sim \log(t)$ . Some speculate that similar growing barriers are responsible for the slow relaxation in glass-forming liquids (Section 12.3.4).

- **Non-universality.** Much of the motivation for studying coarsening by physicists has been the close analogies with the scaling and power laws seen in continuous phase transitions (Chapter 12 and Exercise 12.3). However, there are important differences. The power laws in coarsening are simpler and in a way more universal—the  $\frac{1}{2}$  and  $\frac{1}{3}$  power laws we derived above are independent of the dimension of space, for example. On the other hand, for coarsening in crystals the scaling behavior and morphology is not universal; it will depend upon the anisotropic free energies and mobilities of the interfaces [112]. Basically each combination of materials and temperatures will have different scaling functions at late times. In retrospect this is reassuring; there is such a bewildering variety of microstructures in materials science and mineralogy that it made no sense for one scaling function to rule them all.

#### 11.4.2 Martensites

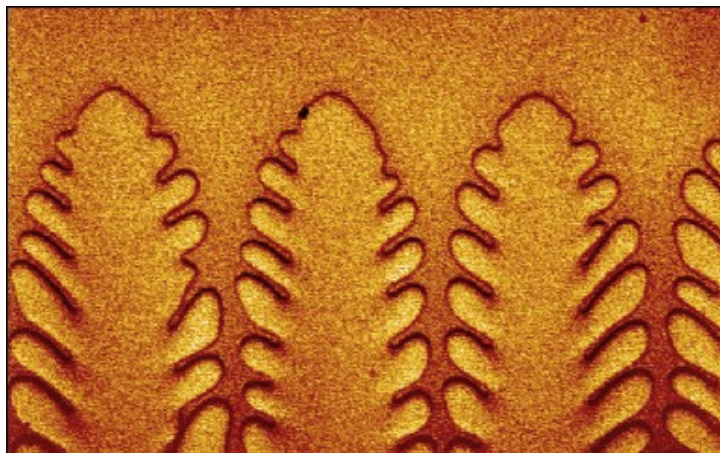
Many crystals will undergo abrupt structural rearrangements as they are cooled—phase transitions between different crystal structures. A good example might be a cubic crystal stretching along one axis and shrinking along the other two. These transitions are often problematic; when part of the sample has transformed and the rest has not, the tearing stress at the interface often shatters the crystal.

In many materials (such as<sup>17</sup> iron) the crystalline shape transition bypasses large-scale stress build-up in the crystal by developing intricate layered structures. Figure 11.11 shows a picture of a martensite, showing how it forms a patterned microstructure in order to stretch locally without an overall net strain.

The tool used to study martensites is not statistical mechanics, but mathematics.<sup>18</sup> The basic goal, however, is the same: to minimize the (non-convex) free energy for fixed boundary conditions (see Exercises 9.5, 11.7, and 11.8).

#### 11.4.3 Dendritic growth

Why do snowflakes form [81]? New ice crystals up in the atmosphere initially nucleate as roughly spherical crystals of ice. As the ice crystals continue to grow, however, an instability develops. The tips of the ice crystals that extend furthest into the surrounding supersaturated vapor will grow fastest, both because they see the highest concentration of water vapor and because the heat released by freezing diffuses away fastest at the tips (Exercise 11.9). The characteristic six-fold patterns arise because each snowflake is a single crystal with six-fold symmetry, and different crystal surface orientations grow at different rates. The



**Fig. 11.12 Dendrites.** Growing crystals will typically form branched structures (dendrites), because the tips grow faster than the grooves. Here are shown some dendrites growing into a melt, in a thin film being pulled through a temperature gradient (Bodenschatz, Utter, Ragnarson [18]).

immense variety of snowflake shapes reflects the different thermal and humidity variations experienced by each snowflake as it grows.

The same kind of branched patterns, called *dendrites*,<sup>19</sup> also form in other growing crystals, for precisely the same reasons. Frost on your window is one obvious example; Fig. 11.12 shows another example, a solvent crystal growing into a mixture of solvent and polymer. Here, instead of heat being trapped in the grooves, the slowly-diffusing polymer is being trapped and slowing down the solidification process. Many practical metals and alloys used in manufacturing are composed microscopically of tiny dendritic structures packed together.

<sup>19</sup>Dendron is Greek for tree.

## Exercises

The first three exercises, *Maxwell and van der Waals*, *The van der Waals critical point*, and *Interfaces and van der Waals* use an early, classic model for the liquid–gas phase transition to illustrate general features of abrupt phase transitions. The next two exercises, *Nucleation in the Ising model* and *Nucleation of dislocation pairs*, explore analogues of the critical nucleus in magnetic systems (numerically) and in plastic deformation (analytically).

We then illustrate the morphological structure and evolution developed during first-order phase transitions in four exercises. *Coarsening in the Ising model* numerically explores the standard model used to study the growing correlations after rapid cooling. *Origami microstructure* and *Minimizing sequences and microstructure* introduce

us to the remarkable methods used by mathematicians and engineers to study martensites and other boundary-condition-induced microstructure. Finally, *Snowflakes and linear stability* introduces both a model for dendrite formation and the tool of linear stability analysis.

### (11.1) Maxwell and van der Waals. (Chemistry) ③

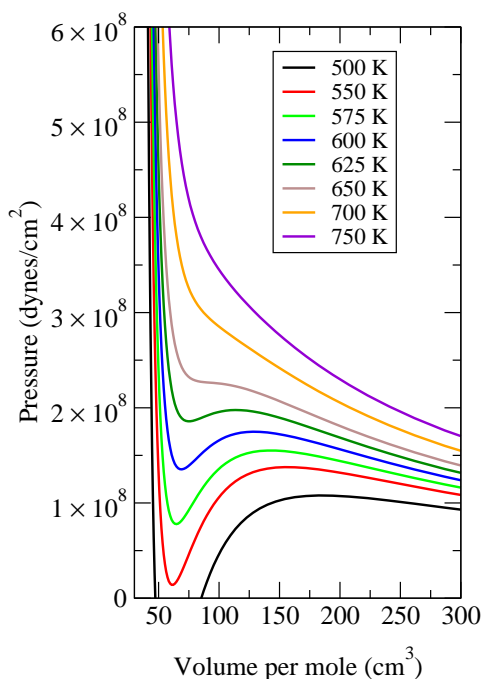
The van der Waals (vdW) equation

$$(P + N^2 a/V^2)(V - Nb) = Nk_B T \quad (11.20)$$

is often applied as an approximate equation of state for real liquids and gases. The term  $V - Nb$  arises from short-range repulsion between

<sup>20</sup>These corrections are to leading orders in the density; they are small for dilute gases.

molecules (Exercise 3.5); the term  $N^2a/V^2$  incorporates the leading effects<sup>20</sup> of long-range attraction between molecules.



**Fig. 11.13**  $P$ - $V$  plot: van der Waals. Van der Waals (vdW) approximation (eqn 11.20) to  $\text{H}_2\text{O}$ , with  $a = 0.55 \text{ J m}^3/\text{mol}^2$  ( $a = 1.52 \times 10^{-35} \text{ erg cm}^3/\text{molecule}$ ), and  $b = 3.04 \times 10^{-5} \text{ m}^3/\text{mol}$  ( $b = 5.05 \times 10^{-23} \text{ cm}^3/\text{molecule}$ ), fit to the critical temperature and pressure for water.

Figure 11.13 shows the vdW pressure versus volume curves for one mole of  $\text{H}_2\text{O}$ . Trace over the figure, or download a version from the book web site [126]. By hand, roughly implement the Maxwell construction for each curve, and sketch the region in the  $P$ - $V$  plane where liquid and gas can coexist.

(11.2) **The van der Waals critical point.** (Chemistry) ③

The top of the coexistence curve in Fig. 11.13 is the pressure, density, and temperature at which the distinction between liquid and gas disappears. It is the focus of much study, as the prime example of a critical point, with self-similar fluctuations and scaling behavior.

(a) Identify this point on a sketch of Fig. 11.13. The vdW constants are fit to the critical tem-

perature  $T_c = 647.3 \text{ K}$  and pressure  $P_c = 22.09 \text{ MPa} = 220.9 \times 10^6 \text{ dyne/cm}^2$ ; check that your estimate for the critical point roughly agrees with the values quoted. I have found few references that quote the critical volume per mole, and the two I have found disagree; one says around  $50 \text{ cm}^3/\text{mol}$  and one says around 55. Plot the true critical point on your sketch. Is the location of the critical density of water predicted well by the vdW equation of state?

(b) Your sketch from Exercise 11.1 may not be precise enough to tell this, but the vdW phase boundaries meet at the critical point with a quadratic maximum:  $1/\rho_\ell - 1/\rho_g \sim (P - P_c)^{1/2}$ , where  $\rho_\ell$  and  $\rho_g$  are the densities on the coexistence boundary (moles per volume) at the pressure  $P$ . Similarly, one can show that the vdW equation of state implies that

$$\rho_\ell - \rho_g \sim (T_c - T)^{1/2} \sim (-t)^{1/2}. \quad (11.21)$$

Compare this latter prediction with Fig. 12.6(a). What critical exponent  $\beta$  does the van der Waals equation predict, assuming eqn 11.21?

(11.3) **Interfaces and van der Waals.** (Chemistry) ③

The chemical potential per particle for the vdW equation of state is

$$\begin{aligned} \mu[\rho] = & -k_B T + P/\rho - a\rho + k_B T \log(\lambda^3 \rho) \\ & - k_B T \log(1 - b\rho), \end{aligned} \quad (11.22)$$

where  $\rho = N/V$  is the density.

(a) Show that  $\mu$  is minimized when  $\rho$  satisfies the vdW equation of state.

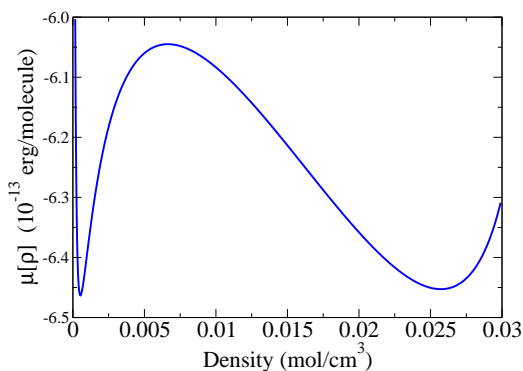
(b) According to the caption to Fig. 11.14, what is the vdW approximation to the vapor pressure at  $373 \text{ K} = 100^\circ\text{C}$ ? How close is the vdW approximation to the true vapor pressure of water? (Hint: Atmospheric pressure is around one bar =  $0.1 \text{ MPa} = 10^6 \text{ dynes/cm}^2$ . What happens when the vapor pressure hits atmospheric pressure?)

We can view Fig. 11.14 as a kind of free energy barrier for the formation of a liquid-gas interface. If  $\mu_0$  is the common chemical potential shared by the water and the vapor at this temperature, the extra Gibbs free energy for a density fluctuation  $\rho(x)$  is

$$\Delta G = \int \rho(x) (\mu[\rho(x)] - \mu_0) d^3x \quad (11.23)$$

since  $\rho(x) d^3x$  is the number of particles that suffer the chemical potential rise  $\mu[\rho(x)]$  in the volume  $d^3x$ .





**Fig. 11.14 Chemical potential: van der Waals.** Chemical potential  $\mu[\rho]$  of water fit with the van der Waals equation, at the boiling temperature of water  $T = 373$  K and the corresponding van der Waals coexistence pressure  $P = 1.5 \times 10^7$  dynes/cm<sup>2</sup>.

(c) At room temperature, the interface between water and water vapor is very sharp: perhaps a molecule thick. This makes the whole idea of using a coarse-grained free energy problematical. Nonetheless, assuming an interfacial width of two or three Ångströms, use the vdW model for the chemical potential (Fig. 11.14) and eqn 11.23 to roughly estimate the surface tension of water (the extra Gibbs free energy per unit area, roughly the barrier height times thickness). How does your answer compare with the measured value at the boiling point, 59 dynes/cm? (One mole =  $6.023 \times 10^{23}$  molecules.)

#### (11.4) Nucleation in the Ising model. ③

The Ising model (Section 8.1) is not only our archetype for a continuous phase transition; it is also our best model for nucleation (this exercise) and for the dynamics of phase separation (Exercise 11.6).

The Ising model can be used to study the nucleation of one phase inside another. Supercooling water and waiting for an ice crystal nucleus to form can be shown to be quite analogous to changing a magnet from external field  $H_{\text{ext}} > 0$  to  $H_{\text{ext}} < 0$  at a temperature  $T < T_c$ . The analogy with changing the temperature or pressure of H<sub>2</sub>O gas and waiting for a raindrop is even better.

Start up the Ising model simulation, available in the computer exercises portion of the book

web site [129]. Run at  $T = 1.5$  (below  $T_c$ ) at size  $40 \times 40$ , initialized with all spins up. Set  $H_{\text{ext}} = -0.3$  and watch the spins. They should eventually flop over to point down, with the new phase starting in a small, roughly circular cluster of spins, which then grows to fill the system.<sup>21</sup>

(a) Using the graph of magnetization versus time, measure the average time it takes to cross zero (which we will call the time to nucleate the down phase), averaging over ten measurements. (You may want to reduce the graphics refresh rate to speed up the simulation.) Similarly measure the average time to nucleate the down phase for  $H_{\text{ext}} = -0.2$ . Since the nucleation center can be located at any site on the lattice, the nucleation rate scales with the number of spins in the system. Calculate, for both fields, the nucleation rate per spin  $\Gamma_{\text{exp}}(H)$ .

We can use critical droplet theory (Section 11.3) to estimate the nucleation rate. Small droplets of the stable phase will shrink due to surface tension  $\sigma$ ; large ones grow due to the free energy difference per unit area  $H_{\text{ext}}\Delta M(T)$ , where  $\Delta M$  is the magnetization difference between the two states. Presuming that the temperature is high and the droplet large and the times long (so that continuum theories are applicable), one can estimate the critical radius  $R_c$  for nucleation.

(b) Give the formula for the free energy of a flipped cluster of radius  $R$  as a function of  $\sigma$ ,  $H$ , and  $\Delta M$ . Give formulae for  $R_c$  (the critical droplet size where the free energy is a local maximum), the resulting barrier  $B$  to nucleation, and the predicted rate  $\Gamma_{\text{theory}} = \exp(-B/T)$  (assuming a prefactor of roughly one attempt per sweep per spin). At low temperatures,  $\sigma \sim 2J \equiv 2$  and  $\Delta M \approx 2$ , since the system is almost fully magnetized and  $\sigma$  is the number of broken bonds ( $2J$  each) per unit length of interface. Make a table with rows for the two fields you simulated and with columns for  $H$ ,  $R_c$ ,  $B$ ,  $\Gamma_{\text{theory}}$ , and  $\Gamma_{\text{exp}}$  from (a).

This should work pretty badly. Is the predicted droplet size large enough (several lattice constants) so that the continuum theory should be valid?

We can test these ideas better by starting with droplets of down-spins (white) in an up background. Use a small system ( $40 \times 40$ ). You can make such a droplet by setting the spins

<sup>21</sup>The system has periodic boundary conditions, so a cluster which starts near a boundary or corner may falsely look like more than one simultaneous nucleation event.

up and then flipping a circular cluster of spins in the center. After making the circle, store it for re-use. You will want to refresh the display each sweep, since the droplet will grow or shrink rather quickly.

(c) Start with  $H = -0.2$ ,  $T = 1.5$  and a down-spin droplet of radius five (diameter of ten), and run ten times. Does it grow more often than it shrinks, or vice versa? (Testing this should be fast.) On the magnetization curve, count the shrinking fraction  $f$ . Make a table of the values of  $H$  and  $f$  you measure. Vary the field  $H$  until the probabilities roughly match; find the field for  $R_c = 5$  to within 0.1. For what field is the theoretical critical droplet radius  $R_c = 5$  at  $T = 1.5$ ? In part (b) we found that critical droplet theory worked badly for predicting the nucleation rate. In part (c) we found that it worked rather well (within a factor of two) at predicting the relationship between the critical droplet size and the external field. This is mostly because the nucleation rate depends exponentially on the barrier, so a small error in the barrier (or critical droplet radius) makes a big error in the nucleation rate. You will notice that theory papers rarely try to predict rates of reactions. They will almost always instead compare theoretical and experimental barrier heights (or here, critical droplet radii). This avoids embarrassment.

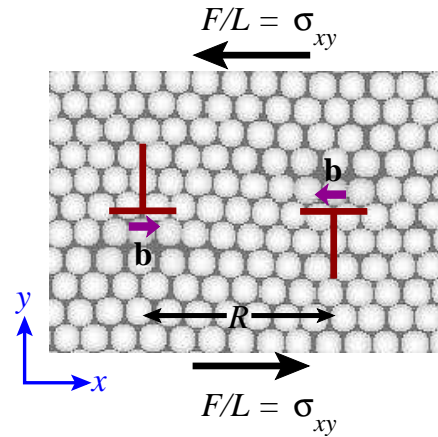
This free energy barrier to nucleation is what allows supercooled liquids and supersaturated vapor to be stable for long periods.

(11.5) **Nucleation of dislocation pairs.** (Engineering) ③

Consider a two-dimensional crystal under shear shown in Fig. 11.15.<sup>22</sup> The external force is being relieved by the motion of the upper half of the crystal to the left with respect to the bottom half of the crystal by one atomic spacing  $a$ . If the crystal is of length  $L$ , the energy released by this shuffle when it is complete will be  $|F|a = \sigma_{xy}La$ . This shuffling has only partially been completed; only the span  $R$  between the two edge dislocations has been shifted (the dislocations are denoted by the conventional ‘tee’ representing the end of the extra column of atoms). Thus the strain energy released by the dislocations so far is

$$|F|aR/L = \sigma_{xy}Ra. \quad (11.24)$$

This energy is analogous to the bulk free energy gained for a liquid droplet in a supercooled gas.



**Fig. 11.15 Dislocation pair** in a 2D hexagonal crystal. A loop around the defect on the right shows an extra row of atoms coming in from the bottom. By the conventions used in materials physics (assuming here that the dislocation ‘points’ up out of the paper, see [57, Figure 1.20, p. 23]) this *edge dislocation* has Burgers vector  $\mathbf{b} = a\hat{x}$ , where  $a$  is the distance between neighboring atoms. Similarly, the defect on the left has an extra row of atoms coming in from the bottom, and has  $\mathbf{b} = -a\hat{x}$ . The defects are centered at the same height, separated by a distance  $R$ . The crystal is under a shear stress  $\sigma_{xy} = F/L$ , where the force  $F = \pm\sigma_{xy}L\hat{y}$  is applied to the top and bottom as shown (and the crystal is kept from rotating). (Figure by Nicholas Bailey.)

The dislocations, however, cost energy (analogous to the surface tension of the vapor droplet). They have a fixed core energy  $C$  that depends on the details of the interatomic interaction, and a long-range interaction energy which, for the geometry shown in Fig. 11.15, is

$$\frac{\mu}{2\pi(1-\nu)}a^2 \log(R/a). \quad (11.25)$$

<sup>22</sup>A similar problem, for superfluids, was studied in [2, 3], see also [136]. The complete solution is made more complex by the effects of other dislocation pairs renormalizing the elastic constants at high temperatures.

Here  $\mu$  is the 2D shear elastic constant<sup>23</sup> and  $\nu$  is Poisson's ratio. For this exercise, assume the temperature is low (so that the energies given by eqns 11.24 and 11.25 are good approximations for the appropriate free energies). By subtracting the energy gained from the dislocation from the energy cost, one finds in analogy to other critical droplet problems a critical radius  $R_c$  and a barrier height for thermally nucleated dislocation formation  $B$ .

Of the following statements, which are true?

(T) (F) The critical radius  $R_c$  is proportional to  $1/\sigma_{xy}$ .

(T) (F) The energy barrier to thermal nucleation is proportional to  $1/\sigma_{xy}^2$ .

(T) (F) The rate  $\Gamma$  of thermal nucleation of dislocations predicted by our critical droplet calculation is of the form  $\Gamma = \Gamma_0(T) (\sigma_{xy}/\mu)^{D/k_B T}$ , for a suitable material-dependent function  $\Gamma_0(T)$  and constant  $D$ .

Dislocations mediate plastic shear. For a small sample, each pair of dislocations nucleated will travel to opposite boundaries of the system and lead to a net shear of one lattice constant. Thus, at any non-zero temperature and external stress, a (two-dimensional) crystal will shear at a non-zero rate. How is the crystal, then, different in its response from a liquid?

(T) (F) According to our calculation, the response of a two-dimensional crystal under stress is indistinguishable from that of a liquid; even at low temperatures, the strain rate due to an external shear force is proportional to the stress.

### (11.6) Coarsening in the Ising model. ③

Coarsening is the process by which phases separate from one another; the surface tension drives tiny fingers and droplets to shrink, leading to a characteristic length scale that grows with time. Start up the Ising model again (computer exercises portion of the book web site [129]). Run with a fairly large system, demagnetize the system to a random initial state ( $T = \infty$ ), and set  $T = 1.5$  (below  $T_c$ ) and run one sweep at a time. (As the pattern coarsens, you may wish to reduce the graphics refresh rate.) The pattern

looks statistically the same at different times, except for a typical *coarsening length* that is growing. How can we define and measure the typical length scale  $L(t)$  of this pattern?

(a) Argue that at zero temperature the total energy above the ground-state energy is proportional to the perimeter separating up-spin and down-spin regions.<sup>24</sup> Argue that the inverse of the perimeter per unit area is a reasonable definition for the length scale of the pattern.

(b) With a random initial state, set temperature and external field to zero, run for one sweep, and measure the mean energy per unit area  $\langle E \rangle$ . Measure the mean energy as a function of time for  $t = 2, 4, 8, \dots$ , and 1024 sweeps, resetting the averaging in between each doubling.<sup>25</sup> Make a table with columns for  $t$ ,  $\langle E(t) \rangle$ , and  $L(t) \propto 1/(\langle E \rangle + 2)$ . Make a log-log plot of your estimate of the coarsening length  $L(t) \propto 1/(\langle E \rangle + 2)$  versus time. What power law does it grow with? What power law did we expect?

### (11.7) Origami microstructure.<sup>26</sup> (Mathematics, Engineering) ③

Figure 11.11 shows the domain structure in a thin sheet of material that has undergone a *martensitic* phase transition. These phase transitions change the shape of the crystalline unit cell; for example, the high-temperature phase might be cubic, and the low-temperature phase might be stretched along one of the three axes and contracted along the other two. These three possibilities are called *variants*. A large single crystal at high temperatures thus can transform locally into any one of the three variants at low temperatures.

The order parameter for the martensitic transition is a *deformation field*  $\mathbf{y}(\mathbf{x})$ , representing the final position  $\mathbf{y}$  in the martensite of an original position  $\mathbf{x}$  in the undeformed, unrotated austenite. The variants differ by their *deformation gradients*  $\nabla \mathbf{y}$  representing the stretch, shear, and rotation of the unit cells during the crystalline shape transition.

In this exercise, we develop an analogy between martensites and paper folding. Consider a piece of graph paper, white on one side and gray on the

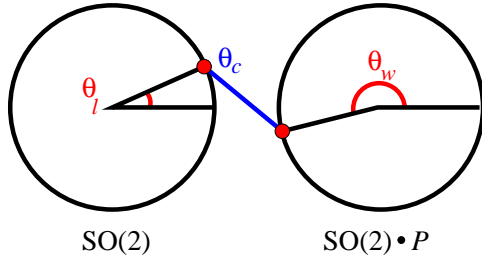
<sup>23</sup>The 2D elastic constants  $\mu$  and  $\nu$  can be related to their 3D values; in our notation  $\mu$  has units of energy per unit area.

<sup>24</sup>At finite temperatures, there is a contribution from thermally flipped spins, which should not really count as perimeter for coarsening.

<sup>25</sup>You are measuring the average perimeter length over the last half of the time interval, but that scales in the same way as the perimeter does.

<sup>26</sup>This exercise was developed in collaboration with Richard D. James.

other, lying flat on a table. This piece of paper has two distinct low-energy states, one variant with white side up and one variant with gray side up.



**Fig. 11.16 Paper order parameter space.** The allowed zero-energy deformation gradients for a piece of paper lying flat on a table. Let  $\theta$  be the angle between the  $x$  axis of the graph paper and the near edge of the table. The paper can be rotated by any angle  $\theta_\ell$  (so the deformation gradient is a pure rotation in the group<sup>27</sup> SO(2)). Or, it can be flipped over horizontally ( $(x, y) \rightarrow (x, -y)$ , multiplying by  $P = \begin{pmatrix} 1 & 0 \\ 0 & -1 \end{pmatrix}$ ) and then rotated by  $\theta_w$  (deformation gradient in the set SO(2)·P). Our two variants are hence given by the identity rotation  $\mathbb{I}$  and the reflection  $P$ ; the ground states rotate the two variants. An interface between two of these ground states is a straight crease at angle  $\theta_c$  (Fig. 11.17).

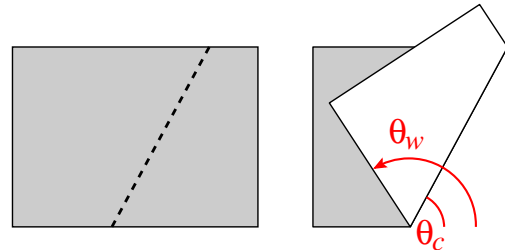
The (free) energy density for the paper is independent of rotations, but grows quickly when the paper is stretched or sheared. The paper, like martensites, can be represented as a deformation field  $\mathbf{y}(\mathbf{x})$ , representing the final position  $\mathbf{y}$  of a point  $\mathbf{x}$  of the paper placed horizontally on the table with the gray side up. Naturally  $\mathbf{y}(\mathbf{x})$  must be a continuous function to avoid ripping the paper. Since the energy is independent of an overall translation of the paper on the table, it can depend only on gradients of the deformation field. To lowest order,<sup>28</sup> the energy density can be written in terms of the deformation gradient

$$\nabla \mathbf{y} = \partial_j y_i:$$

$$\mathcal{F} = \alpha |(\nabla \mathbf{y})^\top \nabla \mathbf{y} - \mathbb{I}|^2 = \alpha (\partial_i y_j \partial_i y_k - \delta_{jk})^2. \tag{11.26}$$

The constant  $\alpha$  is large, since paper is hard to stretch. In this problem, we will be interested in the zero-energy ground states for the free energy. (a) Show that the zero-energy ground states of the paper free energy density (eqn 11.26) include the two variants and rotations thereof, as shown in Fig. 11.16. Specifically, show (1) that any rotation  $y_i(x_j) = R_{ij}x_j$  of the gray-side-up position is a ground state, where  $R_{ij} = \begin{pmatrix} \cos \theta_\ell & -\sin \theta_\ell \\ \sin \theta_\ell & \cos \theta_\ell \end{pmatrix}$ , and (2) that flipping the paper to the white-side-up and then rotating,  $y_i(x_j) = R_{ik}P_{kj}x_j = \begin{pmatrix} \cos \theta_w & -\sin \theta_w \\ \sin \theta_w & \cos \theta_w \end{pmatrix} \begin{pmatrix} 1 & 0 \\ 0 & -1 \end{pmatrix} \begin{pmatrix} x \\ y \end{pmatrix}$  also gives a ground state. Hence our two variants are the rotations  $\mathbb{I} = \begin{pmatrix} 1 & 0 \\ 0 & 1 \end{pmatrix}$  and  $P = \begin{pmatrix} 1 & 0 \\ 0 & -1 \end{pmatrix}$ .

In the real martensite, there are definite rules (or *compatibility conditions* for boundaries between variants: given one variant, only certain special orientations are allowed for the boundary and the other variant. A boundary in our piece of paper between a gray-up and white-up variant lying flat on the table is simply a crease (Fig. 11.17).



**Fig. 11.17 Paper crease.** An interface between two ground states  $\theta_\ell = 0$  and  $\theta_w$  for our paper on the table is a straight crease with angle  $\theta_c$ .

(b) Place a piece of paper long-edge downward on the table. Holding the left end fixed  $\theta_\ell = 0$ , try folding it along crease lines at different angles  $\theta_c$ . Find a definite relation between the crease angle

<sup>27</sup>A matrix  $M$  is a rotation matrix if  $M^\top M = \mathbb{I}$ , which means that the columns of  $M$  (the images of the coordinate axes) are orthonormal. Such a matrix is called *orthogonal*. The set of all  $n \times n$  orthogonal matrices forms a group,  $O(n)$ . Since  $\det(AB) = \det(A)\det(B)$ , and  $\det(M^\top) = \det(M)$ , orthogonal matrices  $M$  either have  $\det(M) = 1$  (so-called *special orthogonal* matrices, in the group SO( $n$ )) or  $\det(M) = -1$  (in which case they are the product of a special orthogonal matrix times the reflection  $P$ ). Thus  $O(n)$  as a set or manifold always comes in two distinct components. Hence in part (a) you are showing that all elements of  $O(2)$  are ground states for the paper.

<sup>28</sup>Including higher derivatives of the deformation field into the energy density would lead to an energy per unit length for the creases.

$\theta_c$  and the angle  $\theta_w$  of the right-hand portion of the paper.

Suppose the crease is along an axis  $\hat{\mathbf{c}}$ . We can derive the compatibility condition governing a crease by noting that  $\mathbf{y}$  along the crease must agree for the white and the gray faces, so the directional derivative  $D\mathbf{y} \cdot \mathbf{c} = (\hat{\mathbf{c}} \cdot \nabla)\mathbf{y}$  must agree. (c) Given the relation you deduced for the geometry in part (b), show that the difference in the directional derivatives ( $D\mathbf{y}^\ell - D\mathbf{y}^w$ ) is zero along  $\mathbf{c}$ ,  $(D\mathbf{y}^\ell - D\mathbf{y}^w) \cdot \mathbf{c} = (\partial_j y_i^\ell - \partial_j y_i^w)c_j = \mathbf{0}$ . (Hints:  $D\mathbf{y}^\ell$  is the identity.  $\cos(2\theta) = \cos^2 \theta - \sin^2 \theta$ ,  $\sin(2\theta) = 2 \sin \theta \cos \theta$ .)

In general, two variants with deformation gradients  $A$  and  $B$  of a martensite can be connected together along a flat boundary perpendicular to  $\mathbf{n}$  if there are rotation matrices  $R^{(1)}$  and  $R^{(2)}$  such that<sup>29</sup>

$$R^{(1)}B - R^{(2)}A = \mathbf{a} \otimes \mathbf{n}, \quad (11.27)$$

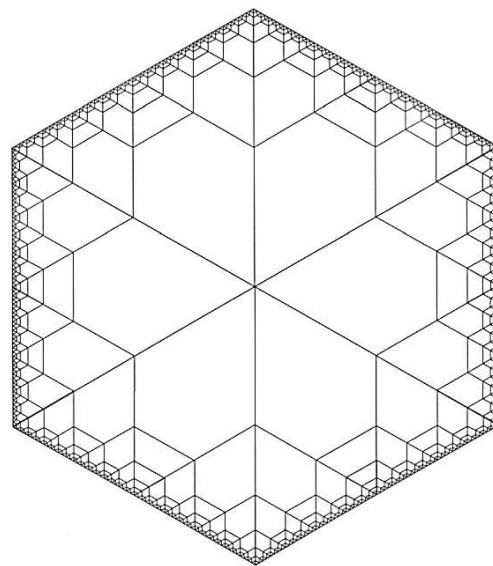
$$\sum_k R_{ik}^{(1)} B_{kj} - \sum_k R_{ik}^{(2)} A_{kj} = a_i n_j,$$

where  $\mathbf{a} \otimes \mathbf{n}$  is the outer product of  $a$  and  $n$ . This compatibility condition ensures that the directional derivatives of  $y$  along a boundary direction  $\mathbf{c}$  (perpendicular to  $\mathbf{n}$ ) will be the same for the two variants,  $(Dy_1 - Dy_2)\mathbf{c} = (R^{(1)}B - R^{(2)}A)\mathbf{c} = \mathbf{a}(\mathbf{n} \cdot \mathbf{c}) = 0$  and hence that the deformation field is continuous at the boundary. For our folded paper,  $Dy$  is either  $R\mathbb{I}$  or  $RP$  for some proper rotation  $R$ , and hence eqn 11.27 is just what you proved in part (c).

As can be seen in Fig. 11.11, the real martensite did not transform by stretching uniformly along one axis. Instead, it formed multiple thin layers of two of the variants. It can do so for a modest energy cost because the surface energy of the boundary between two variants is low.

The martensite is driven to this laminated structure to satisfy *boundary conditions*. Steels go through a martensitic transition; as the blacksmith cools the horseshoe, local crystalline regions of the iron stretch along one of several possible axes. The red-hot horseshoe does not change shape overall as it is plunged into the water, though. This is for two reasons. First, if part of the horseshoe started stretching before the rest, there would be big stresses at the boundary

between the transformed and untransformed regions. Second, a horseshoe is made up of many different crystalline grains, and the stretching is along different axes in different grains. Instead, the horseshoe, to a good approximation, picks a local mixture between the different variants that overall produces no net average stretch.



**Fig. 11.18 Origami microstructure.** Two-dimensional origami example of microstructure formation, by Richard D. James.

This is done by creating finely-divided structures, like the laminated structure seen in Fig. 11.11.<sup>30</sup> At the boundaries of the square region, the martensite must not stretch, so it produces a fine laminated structure where the stretching in one domain cancels the contraction for its neighbors.

Our paper folding example forms a similar microstructure when we insist that the boundary lie along a curve other than the natural one.

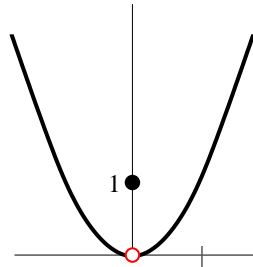
<sup>29</sup>That is, the difference is a *rank one* matrix, with zero eigenvalues along all directions perpendicular to  $\mathbf{n}$ .

<sup>30</sup>The laminated microstructure of the real martensite is mathematically even more strange than that of the paper. The martensite, in the limit where the boundary energy is ignored, has a deformation gradient which is discontinuous everywhere in the region; our folded paper has a deformation gradient which is discontinuous only everywhere along the boundary. See Exercise 11.8.

(d) Go to the book web site [126] and print out a full-sized simplified version of Fig. 11.18. Cut out the hexagon, and fold along the edges. Where does the boundary go?<sup>31</sup>

The mathematicians and engineers who study these problems take the convenient limit where the energy of the boundaries between the variants (the crease energy in our exercise) goes to zero. In that limit, the microstructures can become infinitely fine, and only quantities like the relative mixtures between variants are well defined. It is a wonderful example where the pathological functions of real analysis describe important physical phenomena.

(11.8) **Minimizing sequences and microstructure.**<sup>32</sup> (Mathematics, Engineering) ③



**Fig. 11.19 Function with no minimum.** The function  $g(x) = \begin{cases} x^2, & x \neq 0, \\ 1, & x = 0 \end{cases}$  has a minimum value  $g = 0$ , but never attains that minimum.

The martensitic morphology seen in Fig. 11.11 is a finely-divided mixture between two different crystal variants. This layered structure (or *laminate*) is produced by the material to minimize the strain energy needed to glue the different domains together. If the interfacial energy needed to produce the boundaries between the domains were zero, the layering could become infinitely fine, leading to a mathematically strange function. The displacement field  $\mathbf{y}(\mathbf{x})$  in this limit would be continuous, and at each point<sup>33</sup>  $\mathbf{x}$  it would have a gradient which agrees with one of

the ground states. However, the gradient would be discontinuous everywhere, jumping from one variant to the next each time a boundary between domains is crossed.

It is in this weird limit that the theory of martensites becomes elegant and comprehensible. If you are thinking that no such function  $\mathbf{y}(\mathbf{x})$  exists, you are correct; one can approach zero strain energy with finer and finer laminates, but no function  $\mathbf{y}(\mathbf{x})$  can actually have zero energy. Just as for the function in Fig. 11.19, the greatest lower bound of the martensitic energy *exists*, but is not *attained*.

A *minimizing sequence* for a function  $g(x)$  with lower bound  $g_0$  is a sequence of arguments  $x_1, x_2, \dots$  for which  $g(x_n) > g(x_{n+1})$  and  $\lim g(x_n) = g_0$ .

(a) Find a minimizing sequence for the somewhat silly function  $g$  in Fig. 11.19.

This kind of microstructure often arises in systems with *non-convex* free energy densities. Consider a problem where the energy of a function  $y(x)$  is given by

$$\mathcal{F}[y] = \int_0^1 [(y'^2 - 1)^2 + y^2] dx, \quad (11.28)$$

with boundary conditions  $y(0) = y(1) = 0$ . This energy is low if  $y(x)$  stays near zero and the slope  $dy/dx = y'(x)$  stays near  $\pm 1$ . The latter is why it is non-convex: there are two values of the slope which have low energy density, but intermediate values of the slope have higher energy density.<sup>34</sup> This free energy is similar to that for two-dimensional paper folding (Exercise 11.7); you could think of it as the folding of a one-dimensional sheet of paper ( $y' = \pm 1$  representing face-up and face-down states) in a potential  $y^2$  pulling all points to the origin, forcing the paper to crumple into a small ball.

**Microstructure Theorem 1.**  $\mathcal{F}[y]$  of eqn 11.28 does not attain its minimum.

(b) Prove Microstructure Theorem 1.

- Show that zero is a lower bound for the energy  $\mathcal{F}$ .

<sup>31</sup> Deducing the final shape of the boundary can be done by considering how the triangles along the edge overlap after being folded. Note that the full structure of Fig. 11.18 can't be folded in three dimensions, because the paper must pass through itself (Chen Wang, private communication, see [126]). The analogous problem does not arise in martensites.

<sup>32</sup> This exercise was developed in collaboration with Richard D. James.

<sup>33</sup> Except on the boundaries between domains, which although dense still technically have measure zero.

<sup>34</sup> A function  $f[x]$  is convex if  $f[\lambda a + (1 - \lambda)b] \leq \lambda f[a] + (1 - \lambda)f[b]$ ; graphically, the straight line segment between the two points  $(a, f[a])$  and  $(b, f[b])$  lies above  $f$  if  $f$  is convex. The free energy  $\mathcal{F}$  in eqn 11.28 is non-convex as a function of the slope  $y'$ .

- Construct a minimizing sequence of functions  $y_n(x)$  for which  $\lim \mathcal{F}[y_n] = 0$ .
- Show that the second term of  $\mathcal{F}[y]$  is zero only for  $y(x) = 0$ , which does not minimize  $\mathcal{F}$ .

(Advanced) *Young measures.* It is intuitively clear that any minimizing sequence for the free energy of eqn 11.28 must have slopes that approach  $y' \approx \pm 1$ , and yet have values that approach  $y \approx 0$ . Mathematically, we introduce a probability distribution (the *Young measure*)  $\nu_x(S)$  giving the probability of having slope  $S = y'(x + \epsilon)$  for points  $x + \epsilon$  near  $x$ .

(c) Argue that the Young measure which describes minimizing sequences for the free energy in eqn 11.28 is  $\nu_x(S) = \frac{1}{2}\delta(S - 1) + \frac{1}{2}\delta(S + 1)$ . Hint: The free energy is the sum of two squares. Use the first term to argue that the Young measure is of the form  $\nu_x(S) = a(x)\delta(S - 1) + (1 - a(x))\delta(S + 1)$ . Then write  $\langle y(x) \rangle$  as an integral involving  $a(x)$ , and use the second term in the free energy to show  $a(x) = \frac{1}{2}$ .

(11.9) **Snowflakes and linear stability.** (Condensed matter) ③

Consider a rather ‘clunky’ two-dimensional model for the nucleation and growth of an ice crystal, or more generally a crystal growing in a supercooled liquid. As in coarsening with conserved order parameters, the driving force is given by the supercooling, and the bottle-neck to motion is diffusion. For ice crystal formation in the atmosphere, the growing ice crystal consumes all of the water vapor near the interface; new atoms must diffuse in from afar. In other systems the bottle-neck might be diffusion of latent heat away from the interface, or diffusion of impurity atoms (like salt) that prefer the liquid phase.

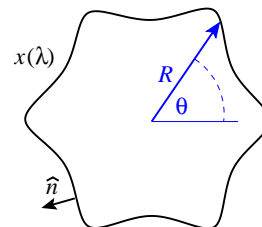
The current shape of the crystal is given by a curve  $\mathbf{x}(\lambda, t)$  giving the current solid–liquid interface, parameterized by  $\lambda$ .<sup>35</sup> If  $\hat{n}$  is the local unit normal pointing outward from crystal into liquid, and  $\mathcal{S}(\kappa)$  is the local growth speed of the crystal as a function of the local curvature  $\kappa$  of the interface, then<sup>36</sup>

$$\hat{n} \cdot \frac{\partial \mathbf{x}}{\partial t} = \mathcal{S}(\kappa) = A + B\kappa - C\kappa|\kappa|. \quad (11.29)$$

<sup>35</sup>We are free to choose any parameterization  $\lambda$  we wish. Typical choices for  $\lambda$  might be the angle  $\theta$  in polar coordinates or the arc length around the interface. The curvature  $\kappa$ , and more generally the equations of motion 11.29, must be *gauge invariant*: carefully written to be independent of how we measure (gauge) the position  $\lambda$  around the curve.

<sup>36</sup>The component of  $\partial \mathbf{x} / \partial t$  parallel to the interface does not affect the growth; it only affects the time-dependent parameterization of the curve.

Equation 11.29 has been chosen to reproduce the physics of nucleation and coarsening of circular droplets of radius  $R(t)$  and curvature  $\kappa = 1/R$ .



**Fig. 11.20 Crystal shape coordinates** A crystalline nucleus with six incipient fingers (see Fig. 11.12 for a fully-formed dendrite). We describe the crystal–liquid interface in two dimensions either with a parameterized curve  $\mathbf{x}(\lambda)$  or, more specifically, with the radius  $R(\theta)$ .

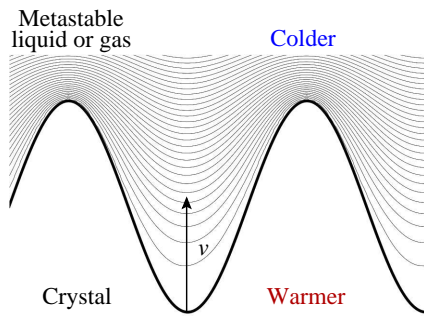
(a) Generalize the coarsening law for conserved-order parameters (eqn 11.18) and the calculation for the critical nucleus size (eqn 11.9) to two-dimensional droplets. Setting  $A = B = 0$  in eqn 11.29, what value of  $C$  reproduces the coarsening law in 2D? What value for  $A$  then yields the correct critical nucleus radius?

Hence  $A$  represents the effects of undercooling (favoring crystal over vapor) and  $C$  represents the effects of surface tension.

(b) Consider an interface with regions of both positive and negative curvature (as in Fig. 11.21). What direction should the surface tension push the fingertip regions of positive curvature  $\kappa$ ? What direction should the surface tension push the interface in the channels (negative  $\kappa$ )? Would an analytic term  $C\kappa^2$  in eqn 11.29 have given the correct behavior?

The term  $B\kappa$  speeds up regions of positive curvature (crystalline fingers) and slows down regions of negative curvature (channels left behind). It crudely mimics the diffusion of heat or impurities away from the interface (Fig. 11.21): the growing ice tips probe colder, more humid regions.

Our model is ‘clunky’ because it tries to model the non-local effects of the diffusion [74] into a local theory [20]. More microscopic models include an explicit thermal boundary layer [11, 12].<sup>37</sup> The basic physical picture, however, nicely mimics the more realistic treatments.



**Fig. 11.21 Diffusion field ahead of a growing interface.** Contours of temperature, water vapor concentration, or salt concentration in the liquid ahead of a growing crystal (dark curve). Notice that the gradients are low in the troughs and high at the tips of the fingers; this allows the tips to grow faster. We do not plot the contours in the crystal.

We will take the growing circular droplet solution, and look to see if a small oscillation of the interface will grow or shrink with time. We can parameterize a nearly circular droplet with a curve  $R(\theta, t)$ . In these coordinates the curvature is given by

$$\kappa = \frac{R^2 + 2(\partial R/\partial\theta)^2 - R(\partial^2 R/\partial\theta^2)}{(R^2 + (\partial R/\partial\theta)^2)^{3/2}}. \quad (11.30)$$

Check that  $\kappa = 1/R$  for a perfect circle.

(c) Write  $\hat{n} \cdot \partial\mathbf{x}/\partial t$ , the left-hand side of eqn 11.29, in terms of  $\partial R/\partial t$ ,  $R$ , and  $\partial R/\partial\theta$ . (Hints:  $\hat{n}$  is the unit vector perpendicular to the local tangent to the interface  $[\partial(R \cos \theta)/\partial\theta, \partial(R \sin \theta)/\partial\theta]$ , pointing outward. Here  $\partial\mathbf{x}/\partial t$  points along  $\hat{r}$ , because we chose  $\theta$  as our parameterization.<sup>38</sup> Your answer should not have an explicit dependence on  $\theta$ .)

<sup>37</sup>In particular, this is why we need a non-analytic term  $\kappa|\kappa|$ . Also, our growth rate  $A$  for a flat interface is not realistic. For  $\Delta T < L/c$ , for example, the latent heat is too large to be absorbed by the undercooling; the final state is a mixture of ice and water, so only fingered interfaces can grow (and never close).

<sup>38</sup>The coordinate  $\theta$  does not change as we evolve  $t$ , because the parameterization  $\theta$  varies to keep it fixed, if that helps.

<sup>39</sup>That is,  $r_m$  for  $m = 0$ .

Small ice crystals shrink, larger ones grow. Even larger ones grow fingers, or *dendrites* (Fig. 11.12). We can use *linear stability analysis* to find the size at which the circular droplet starts growing fingers. Linear stability analysis takes an exact solution and sees whether it is stable to small perturbations.

Expand  $R(\theta, t) = \sum_{m=-\infty}^{\infty} r_m(t) \exp(im\theta)$ . We want to know, for each number of fingers  $m$ , at what average radius<sup>39</sup>  $r_0$  the fingers will start to grow.



**Fig. 11.22 Snowflake.** (© Ken Libbrecht, from snowcrystals.com [80, 81].)

(d) Assume  $r_m(t)$  is small for  $m \neq 0$ , and expand eqn 11.29 (written in polar coordinates as in eqn 11.30 and part (c)) to linear order in  $r_m$  and its derivatives. Write the evolution law for  $\partial r_m/\partial t$  in terms of  $r_m$  and  $r_0$  (but not  $r_n$  for other integers  $n$ ). In terms of  $A$ ,  $B$ , and  $C$ , give the radius  $r_0$  at which the fingers will start to grow. (Hint: After linearizing, multiply by  $e^{-im\theta}$  and integrate over  $\theta$ ; then use the orthogonality properties of the Fourier transform,



eqn A.27.)

Whenever you find a simple exact solution to a problem, you can test the stability using linear stability analysis as we did here. Add a small perturbation, linearize, and see whether all of the different Fourier modes decay.

The six-fold structure of snowflakes is due to the six-fold molecular crystal structure of ice; the growth rate of the surface depends on angle, another effect that we have ignored in our model.



# Continuous phase transitions

# 12

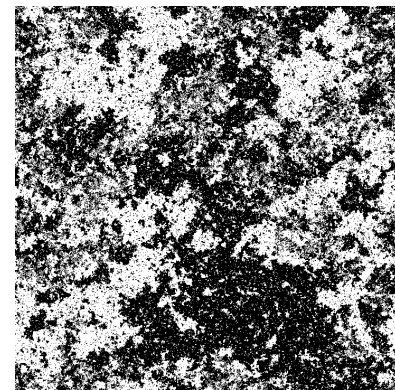
Continuous phase transitions are fascinating. As we raise the temperature of a magnet, the magnetization will vanish continuously at a critical temperature  $T_c$ . At  $T_c$  we observe large fluctuations in the magnetization (Fig. 12.1); instead of picking one of the up-spin, down-spin, or zero-magnetization states, this model magnet at  $T_c$  is a kind of fractal<sup>1</sup> blend of all three. This fascinating behavior is not confined to equilibrium thermal phase transitions. Figure 12.2 shows the *percolation transition*. An early paper which started the widespread study of this topic [78] described punching holes at random places in a conducting sheet of paper and measuring the conductance. Their measurement fell to a very small value as the number of holes approached the critical concentration, because the conducting paths were few and tortuous just before the sheet fell apart. Thus this model too shows a continuous transition: a qualitative change in behavior at a point where the properties are singular but continuous.

Many physical systems involve events of a wide range of sizes, the largest of which are often catastrophic. Figure 12.3(a) shows the energy released in earthquakes versus time during 1995. The Earth's crust responds to the slow motion of the tectonic plates in continental drift through a series of sharp, impulsive earthquakes. The same kind of crackling noise arises in many other systems, from crumpled paper [59] to Rice Krispies<sup>TM</sup> [68], to magnets [128]. The number of these impulsive *avalanches* for a given size often forms a power law  $D(s) \sim s^{-\tau}$  over many decades of sizes (Fig. 12.3(b)). In the last few decades, it has been recognized that many of these systems can also be studied as critical points—continuous transitions between qualitatively different states. We can understand most of the properties of large avalanches in these systems using the same tools developed for studying equilibrium phase transitions.

The renormalization-group and scaling methods we use to study these critical points are deep and powerful. Much of the history and practice in the field revolves around complex schemes to implement these methods for various specific systems. In this chapter, we will focus on the key ideas most useful in exploring experimental systems and new theoretical models, and will not cover the methods for calculating critical exponents.

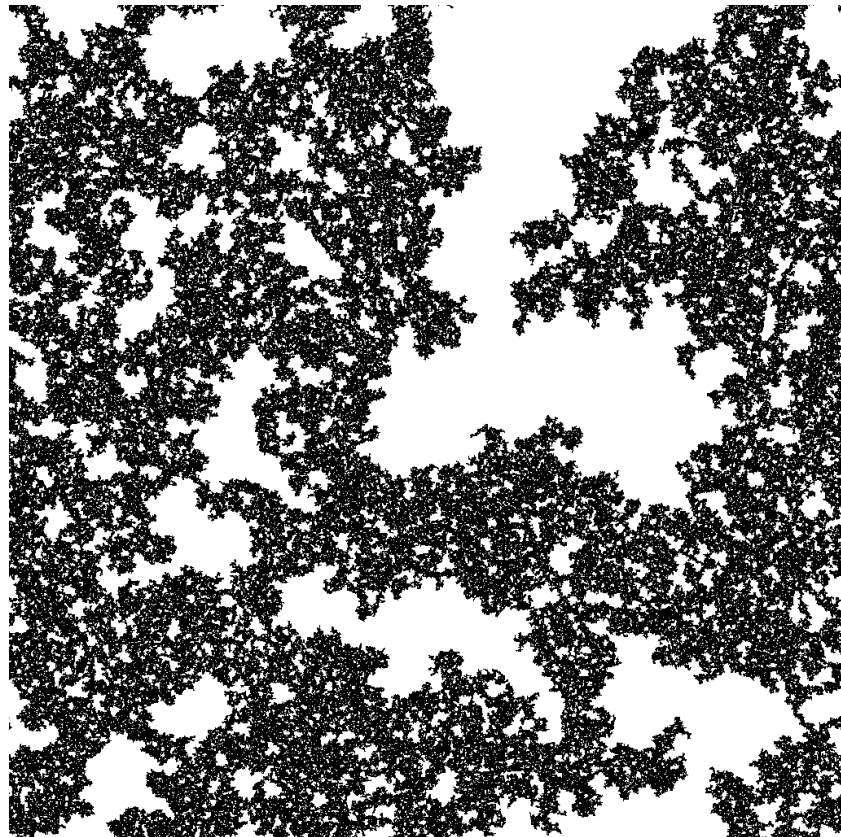
In Section 12.1 we will examine the striking phenomenon of *universality*: two systems, microscopically completely different, can exhibit pre-

12.1 Universality	265
12.2 Scale invariance	272
12.3 Examples of critical points	277

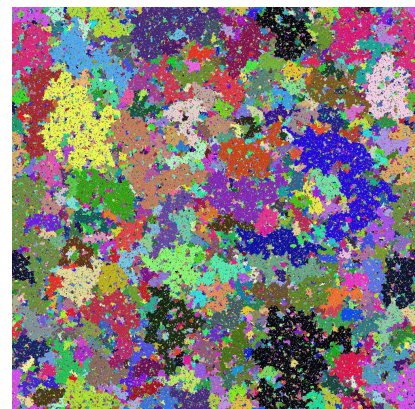
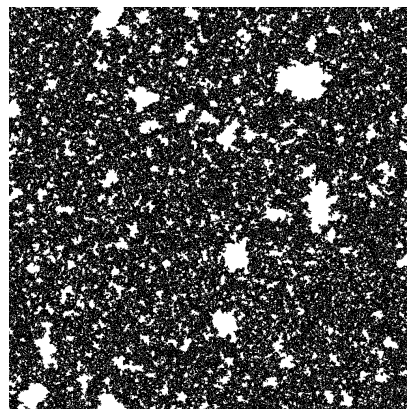


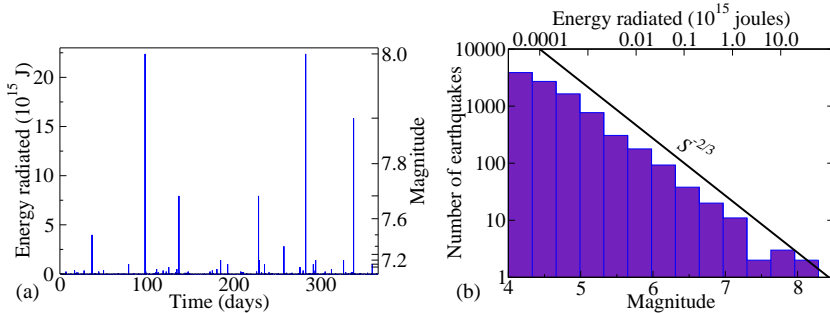
**Fig. 12.1** The Ising model at  $T_c$ , the critical temperature separating the magnetized phase  $T < T_c$  from the zero-magnetization phase  $T > T_c$ . The white and black regions represent positive and negative magnetizations  $s = \pm 1$ . Unlike the abrupt transitions studied in Chapter 11, here the magnetization goes to zero continuously as  $T \rightarrow T_c$  from below.

<sup>1</sup>The term *fractal* was coined to describe sets which have characteristic dimensions that are not integers; it roughly corresponds to non-integer Hausdorff dimensions in mathematics. The term has entered the popular culture, and is associated with strange, rugged sets like those depicted in the figures here.



**Fig. 12.2 Percolation transition.** A percolation model on the computer, where bonds between grid points are removed rather than circular holes. Let the probability of removing a bond be  $1-p$ ; then for  $p$  near one (no holes) the conductivity is large, but decreases as  $p$  decreases. After enough holes are punched (at  $p_c = 1/2$  for this model), the biggest cluster just barely hangs together, with holes on all length scales. At larger probabilities of retaining bonds  $p = 0.51$ , the largest cluster is intact with only small holes (bottom left); at smaller  $p = 0.49$  the sheet falls into small fragments (bottom right; shadings denote clusters). Percolation has a phase transition at  $p_c$ , separating a connected phase from a fragmented phase (Exercises 2.13 and 12.12).





**Fig. 12.3 Earthquake sizes.** (a) Earthquake energy release in 1995 versus time. This time series, when sped up, sounds like crackling noise [68]. (b) Histogram of the number of earthquakes in 1995 as a function of their size  $S$ . Notice the logarithmic scales; the smallest earthquakes shown are a million times smaller and a thousand times more probable than the largest earthquakes. The fact that this distribution is well described by a power law is the Gutenberg–Richter law  $\sim S^{-2/3}$ .

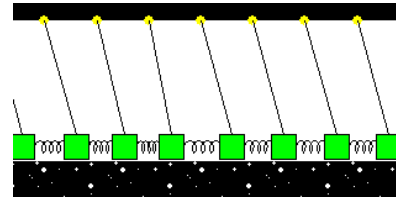
cisely the same critical behavior near their phase transitions. We will provide a theoretical rationale for universality in terms of a *renormalization-group* flow in a space of all possible systems.

In Section 12.2 we will explore the characteristic *self-similar* structures found at continuous transitions. Self-similarity is the explanation for the fractal-like structures seen at critical points: a system at its critical point looks the same when rescaled in length (and time). We will show that *power laws* and *scaling functions* are simply explained from the assumption of self-similarity.

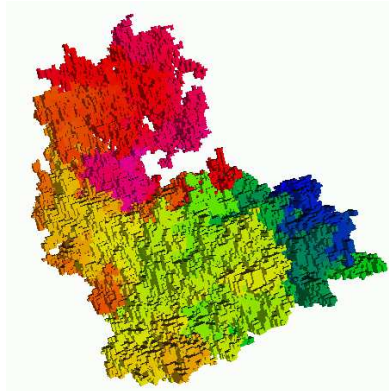
Finally, in Section 12.3 we will give an overview of the wide variety of types of systems that are being understood using renormalization-group and scaling methods.

## 12.1 Universality

Quantitative theories of physics are possible because macroscale phenomena are often independent of microscopic details. We saw in Chapter 2 that the diffusion equation was largely independent of the underlying random collision processes. Fluid mechanics relies upon the emergence of simple laws—the Navier-Stokes equations—from complex underlying microscopic interactions; if the macroscopic fluid motions depended in great detail on the shapes and interactions of the constituent molecules, we could not write simple continuum laws. Ordinary quantum mechanics relies on the fact that the behavior of electrons, nuclei, and photons are largely independent of the details of how the nucleus is assembled—non-relativistic quantum mechanics is an effective theory which emerges out of more complicated unified theories at low energies. High-energy particle theorists developed the original notions of *renormalization* in order to understand how these effective theories emerge in relativistic quantum systems. Lattice quantum chromodynamics (simulating the strong interaction which assembles the nucleus) is useful only because a lattice simulation which breaks translational, rotational, and Lorentz symmetries can lead on long length scales to a behavior that nonetheless exhibits these symmetries. In each of these fields of physics,



**Fig. 12.4 The Burridge–Knopoff model of earthquakes**, with the earthquake fault modeled by blocks pulled from above and sliding with friction on a surface below. It was later realized by Carlson and Langer [26] that this model evolves into a state with a large range of earthquake sizes even for regular arrays of identical blocks.



**Fig. 12.5** A medium-sized avalanche (flipping 282785 domains) in a model of avalanches and hysteresis in magnets [128] (see Exercises 8.13, 12.13 and Fig. 12.11). The shading depicts the time evolution: the avalanche started in the dark region in the back, and the last spins to flip are in the upper, front region. The sharp changes in shading are real, and represent sub-avalanches separated by times where the avalanche almost stops (see Fig. 8.18).

<sup>2</sup>Here  $B = T_c^M/T_c^{\ell g}$  is as usual the rescaling of temperature and  $A(M, T) = a_1 M + a_2 + a_3 T = (\rho_c \rho_0/M_0)M + \rho_c(1+s) - (\rho_c s/T_c^{\ell g})T$  is a simple shear coordinate transformation from  $(\rho, T^{\ell g})$  to  $(M, T^M)$ . As it happens, there is another correction proportional to  $(T_c - T)^{1-\alpha}$ , where  $\alpha \sim 0.1$  is the specific heat exponent. It can also be seen as a kind of tilt, from a pressure-dependent effective Ising-model coupling strength. It is small for the simple molecules in Fig. 12.6(a), but significant for liquid metals [47]. Both the tilt and this  $1-\alpha$  correction are *subdominant*, meaning that they vanish faster as we approach  $T_c$  than the order parameter  $(T_c - T)^\beta$ .

<sup>3</sup>The term *generic* is a mathematical term which roughly translates as ‘except for accidents of zero probability’, like finding a function with zero second derivative at the maximum.

many different microscopic models lead to the same low-energy, long-wavelength theory.

The behavior near continuous transitions is unusually independent of the microscopic details of the system—so much so that we give a new name to it, *universality*. Figure 12.6(a) shows that the liquid and gas densities  $\rho_\ell(T)$  and  $\rho_g(T)$  for a variety of atoms and small molecules appear quite similar when rescaled to the same critical density and temperature. This similarity is partly for mundane reasons: the interactions between the molecules is roughly the same in the different systems up to overall scales of energy and distance. Hence argon and carbon monoxide satisfy

$$\rho^{\text{CO}}(T) = A\rho^{\text{Ar}}(BT) \quad (12.1)$$

for some overall changes of scale  $A, B$ . However, Fig. 12.6(b) shows a completely different physical system—interacting electronic spins in manganese fluoride, going through a ferromagnetic transition. The magnetic and liquid–gas theory curves through the data are the same if we allow ourselves to not only rescale  $T$  and the order parameter ( $\rho$  and  $M$ , respectively), but also allow ourselves to use a more general coordinate change

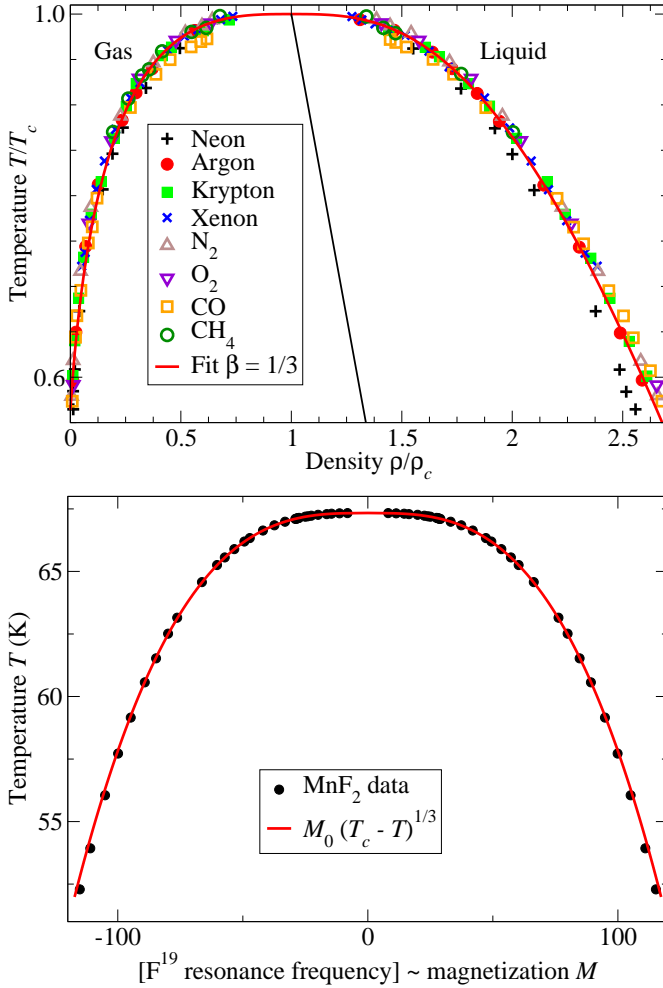
$$\rho^{\text{Ar}}(T) = A(M(BT), T) \quad (12.2)$$

which untilts the axis.<sup>2</sup> Nature does not anticipate our choice of  $\rho$  and  $T$  for variables. At the liquid–gas critical point the natural measure of density is temperature dependent, and  $A(M, T)$  is the coordinate change to the natural coordinates. Apart from this choice of variables, this magnet and these liquid–gas transitions all behave the same at their critical points.

This would perhaps not be a surprise if these two phase diagrams had parabolic tops; the local maximum of an analytic curve generically<sup>3</sup> looks parabolic. But the jumps in magnetization and density near  $T_c$  both vary as  $(T_c - T)^\beta$  with the same exponent  $\beta \approx 0.325$ , distinctly different from the square-root singularity  $\beta = 1/2$  of a generic analytic function.

Also, there are many other properties (susceptibility, specific heat, correlation lengths) which have power-law singularities at the critical point, and all of the exponents of these power laws for the liquid–gas systems agree with the corresponding exponents for the magnets. This is universality. When two different systems have the same singular properties at their critical points, we say they are in the same *universality class*. Importantly, the theoretical Ising model (despite its drastic simplification of the interactions and morphology) is also in the same universality class as these experimental uniaxial ferromagnets and liquid–gas systems—allowing theoretical physics to be directly predictive in real experiments.

To get a more clear feeling about how universality arises, consider site and bond percolation in Fig. 12.7. Here we see two microscopically different systems (left) from which basically the same behavior emerges (right) on long length scales. Just as the systems approach the threshold



**Fig. 12.6 Universality.** (a) Universality at the liquid–gas critical point. The liquid–gas coexistence lines ( $\rho(T)/\rho_c$  versus  $T/T_c$ ) for a variety of atoms and small molecules, near their critical points ( $T_c, \rho_c$ ) [54]. The curve is a fit to the argon data,  $\rho/\rho_c = 1 + s(1 - T/T_c) \pm \rho_0(1 - T/T_c)^\beta$  with  $s = 0.75$ ,  $\rho_0 = 1.75$ , and  $\beta = 1/3$  [54]. (b) Universality: ferromagnetic–paramagnetic critical point. Magnetization versus temperature for a uniaxial antiferromagnet  $MnF_2$  [56]. We have shown both branches  $\pm M(T)$  and swapped the axes so as to make the analogy with the liquid–gas critical point (above) apparent. Notice that both the magnet and the liquid–gas critical point have order parameters that vary as  $(1 - T/T_c)^\beta$  with  $\beta \approx 1/3$ . (The liquid–gas coexistence curves are tilted; the two theory curves would align if we defined an effective magnetization for the liquid–gas critical point  $\rho_{\text{eff}} = \rho - 0.75\rho_c(1 - T/T_c)$  (thin midline, above). This is not an accident; both are in the same universality class, along with the three-dimensional Ising model, with the current estimate for  $\beta = 0.325 \pm 0.005$  [148, chapter 28].

of falling apart, they become similar to one another! In particular, all signs of the original lattice structure and microscopic rules have disappeared.<sup>4</sup>

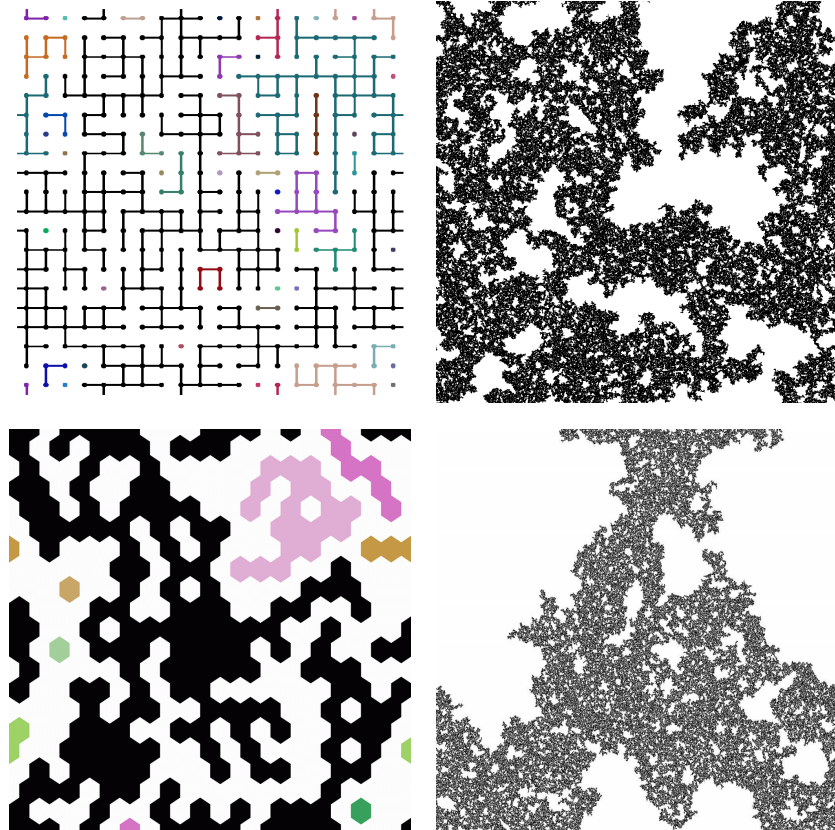
Thus we observe in these cases that different microscopic systems look the same near critical points, if we ignore the microscopic details and confine our attention to long length scales. To study this systematically, we need a method to take a kind of continuum limit, but in systems which remain inhomogeneous and fluctuating even on the largest scales. This systematic method is called the *renormalization group*.<sup>5</sup>

The renormalization group starts with a remarkable abstraction: it

<sup>4</sup>Notice in particular the *emergent symmetries* in the problem. The large percolation clusters at  $p_c$  are statistically both translation invariant and rotation invariant, independent of the grids that underly them. In addition, we will see that there is an emergent *scale invariance*—a kind of symmetry connecting different length scales (as we also saw for random walks, Fig. 2.2).

<sup>5</sup>The word renormalization grew out of quantum electrodynamics, where the effective charge on the electron changes size (norm) as a function of length scale. The word group is usually thought to refer to the family of coarse-graining operations that underly the method (with the group product being repeated coarse-graining). However, there is no inverse operation to coarse-graining, so the renormalization group does not satisfy the definition of a mathematical group.

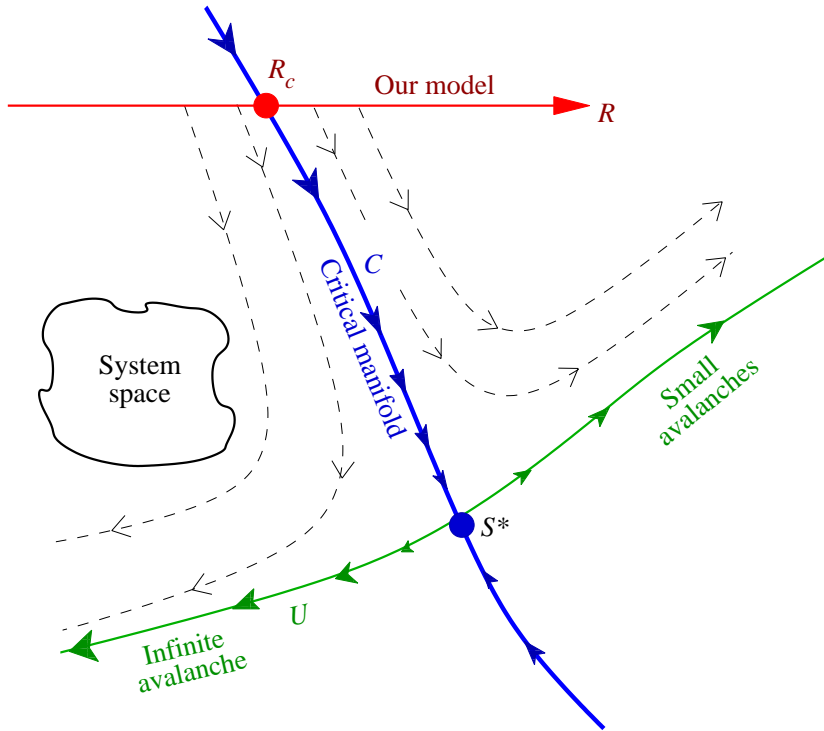
**Fig. 12.7 Universality in percolation.** Universality suggests that the entire morphology of the percolation cluster at  $p_c$  should be independent of microscopic details. On the top, we have bond percolation, where the bonds connecting nodes on a square lattice are occupied at random with probability  $p$ ; the top right shows the infinite cluster on a  $1024 \times 1024$  lattice at  $p_c = 0.5$ . On the bottom, we have site percolation on a triangular lattice, where it is the hexagonal sites that are occupied with probability  $p = p_c = 0.5$ . Even though the microscopic lattices and occupation rules are completely different, the resulting clusters look statistically identical. (One should note that the site percolation cluster is slightly less dark. Universality holds up to overall scale changes, here up to a change in the density.)



works in an enormous ‘system space’. Different points in system space represent different materials under different experimental conditions, and different physical models of these materials with different interactions and evolution rules. So, for example, in Fig. 12.8 we can consider the space of all possible models for hysteresis and avalanches in three-dimensional systems. There is a different dimension in this system space for each possible parameter in a theoretical model (disorder, coupling, next-neighbor coupling, dipole fields, ...) and also for each parameter in an experiment (chemical composition, temperature, annealing time, ...). A given experiment or theoretical model will traverse a line in system space as a parameter is varied; the line at the top of the figure might represent an avalanche model (Exercise 8.13) as the strength of the disorder  $R$  is varied.

The renormalization group studies the way in which system space maps into itself under *coarse-graining*. The coarse-graining operation shrinks the system and removes microscopic degrees of freedom. Ignoring the microscopic degrees of freedom yields a new physical system with identical long-wavelength physics, but with different (renormalized) values of the parameters. As an example, Fig. 12.9 shows a





**Fig. 12.8** The renormalization group defines a mapping from the space of physical systems into itself using a coarse-graining procedure. Consider the system space of all possible models of avalanches in hysteresis [128]. Each model can be coarse-grained into a new model, removing some fraction of the microscopic degrees of freedom and introducing new rules so that the remaining domains still flip at the same external fields. A fixed-point  $S^*$  under this coarse-graining mapping will be self-similar (Fig. 12.11) because it maps into itself under a change in length scale. Points like  $R_c$  that flow into  $S^*$  will also show the same self-similar behavior (except on short length scales that are coarse-grained away during the flow to  $S^*$ ). Models at  $R_c$  and  $S^*$  share the same *universality class*. Systems near to their critical point coarse-grain away from  $S^*$  along the unstable curve  $U$ ; hence they share universal properties too (Fig. 12.12).

real-space renormalization-group ‘majority rule’ coarse-graining procedure applied to the Ising model.<sup>6</sup> Several detailed mathematical techniques have been developed to implement this coarse-graining operation: not only real-space renormalization groups, but momentum-space  $\epsilon$ -expansions, Monte Carlo renormalization groups, etc. These implementations are both approximate and technically challenging; we will not pursue them in this chapter (but see Exercises 12.9 and 12.11).

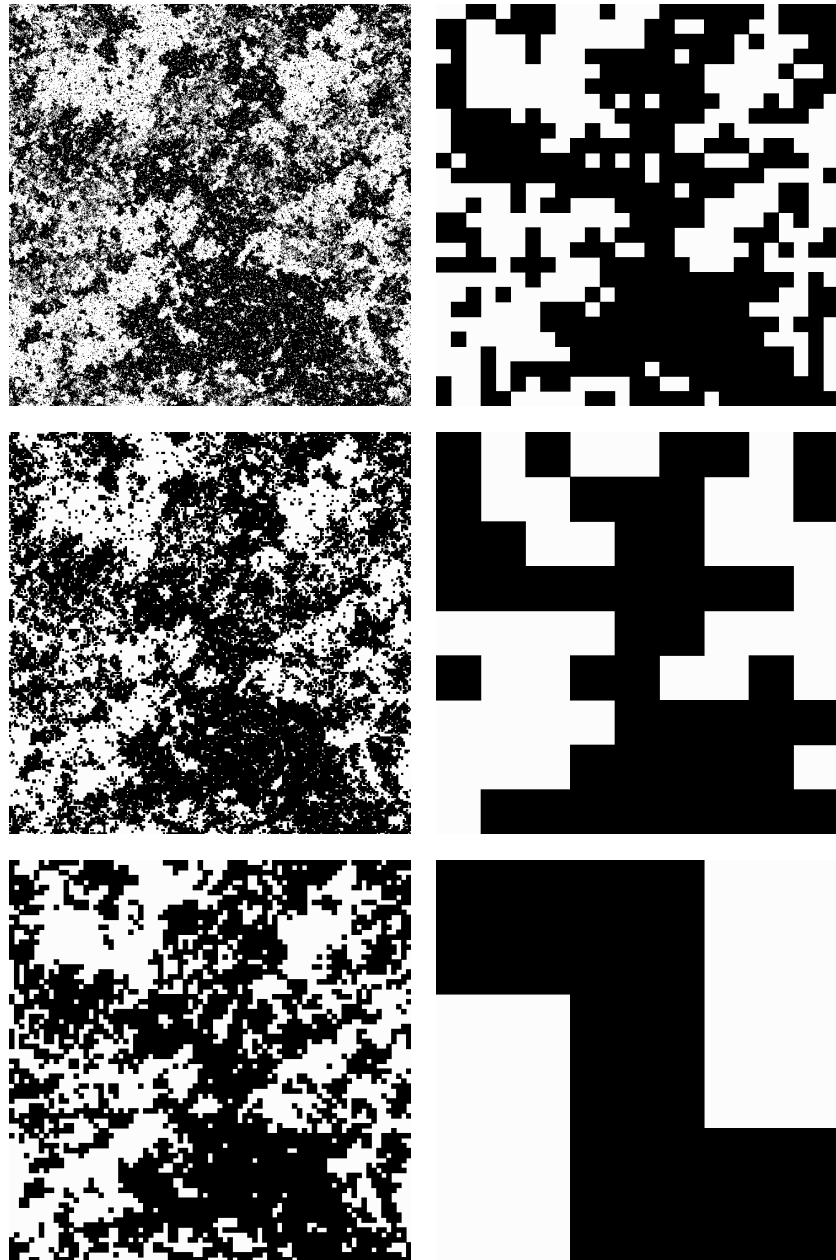
Under coarse-graining, we often find a fixed-point  $S^*$  for this mapping in system space. All the systems that flow into this fixed point under coarse-graining will share the same long-wavelength properties, and will hence be in the same universality class.

Figure 12.8 depicts the flows in system space. It is a two-dimensional picture of an infinite-dimensional space. You can think of it as a planar cross-section in system space, which we have chosen to include the line for our model and the fixed-point  $S^*$ ; in this interpretation the arrows and flows denote projections, since the real flows will point somewhat out of the plane. Alternatively, you can think of it as the curved surface swept out by our model in system space as it coarse-grains, in which case you should ignore the parts of the figure below the curve  $U$ .<sup>7</sup>

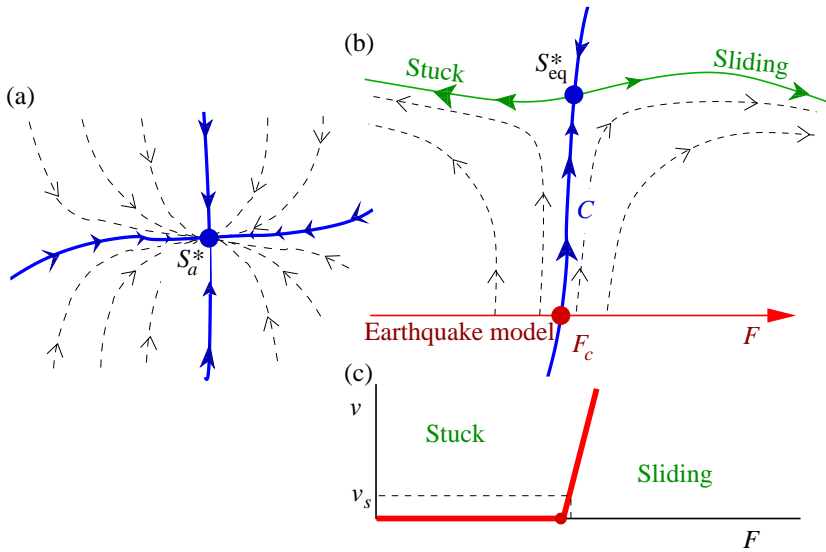
Figure 12.8 shows the case of a fixed-point  $S^*$  that has one unstable direction, leading outward along  $U$ . Points deviating from  $S^*$  in that direction will not flow to it under coarse-graining, but rather will flow

<sup>6</sup>We will not discuss the methods used to generate effective interactions between the coarse-grained spins.

<sup>7</sup>The unstable manifold of the fixed-point.



**Fig. 12.9 Ising model at  $T_c$ : coarse-graining.** Coarse-graining of a snapshot of the two-dimensional Ising model at its critical point. Each coarse-graining operation changes the length scale by a factor  $B = 3$ . Each coarse-grained spin points in the direction given by the majority of the nine fine-grained spins it replaces. This type of coarse-graining is the basic operation of the real-space renormalization group.



**Fig. 12.10 Generic and self-organized criticality.** (a) Often there will be fixed-points that attract in all directions. These fixed-points describe phases rather than phase transitions. Most phases are rather simple, with fluctuations that die away on long length scales. When fluctuations remain important, they will exhibit self-similarity and power laws called *generic scale invariance*. (b) The critical manifold  $C$  in this earthquake model separates a phase of stuck faults from a phase of sliding faults, with the transition due to the external stress  $F$  across the fault. Only along  $C$  does one find self-similar behavior and a broad spectrum of earthquakes. (c) The velocity of the fault will vary as a power law  $v \sim (F - F_c)^\beta$  near the critical force  $F_c$ . The motion of the continental plates, however, drives the fault at a constant, very slow velocity  $v_s$ , automatically setting  $F$  to  $F_c$  and yielding earthquakes of all sizes; the model exhibits *self-organized criticality*.

away from it. Fixed-points with unstable directions correspond to continuous transitions between qualitatively different states. In the case of hysteresis and avalanches, there is a phase consisting of models where all the avalanches remain small, and another phase consisting of models where one large avalanche sweeps through the system, flipping most of the domains. The surface  $C$  which flows into  $S^*$  represents systems at their critical points; hence our model exhibits avalanches of all scales at  $R_c$  where it crosses  $C$ .<sup>8</sup>

Cases like the liquid–gas transition with two tuning parameters ( $T_c, P_c$ ) determining the critical point will have fixed points with two unstable directions in system space. What happens when we have no unstable directions? The fixed-point  $S_a^*$  in Fig. 12.10 represents an entire region of system space that shares long-wavelength properties; it represents a *phase* of the system. Usually phases do not show fluctuations on all scales. Fluctuations arise near transitions because the system does not know which of the available neighboring phases to prefer. However, there are cases where the fluctuations persist even inside phases, leading to *generic scale invariance*. A good example is the case of the random walk<sup>9</sup> where a broad range of microscopic rules lead to the same long-wavelength random walks, and fluctuations remain important on all scales without tuning any parameters.

Sometimes the external conditions acting on a system naturally drive it to stay near or at a critical point, allowing one to spontaneously observe fluctuations on all scales. A good example is provided by certain models of earthquake fault dynamics. Fig. 12.10(b) shows the

<sup>8</sup>Because  $S^*$  has only one unstable direction,  $C$  has one less dimension than system space (mathematically we say  $C$  has *co-dimension one*) and hence can divide system space into two phases. Here  $C$  is the *stable manifold* for  $S^*$ .

<sup>9</sup>See Section 2.1 and Exercises 12.10 and 12.11.

renormalization-group flows for these earthquake models. The horizontal axis represents the external stress on the earthquake fault. For small external stresses, the faults remain stuck, and there are no earthquakes. For strong external stresses, the faults slide with an average velocity  $v$ , with some irregularities but no large events. The earthquake fixed-point  $S_{\text{eq}}^*$  describes the transition between the stuck and sliding phases, and shows earthquakes of all scales. The Earth, however, does not apply a constant stress to the fault; rather, continental drift applies a constant, extremely small velocity  $v_s$  (of the order of centimeters per year). Fig. 12.10(c) shows the velocity versus external force for this transition, and illustrates how forcing at a small external velocity naturally sets the earthquake model at its critical point—allowing spontaneous generation of critical fluctuations, called *self-organized criticality*.

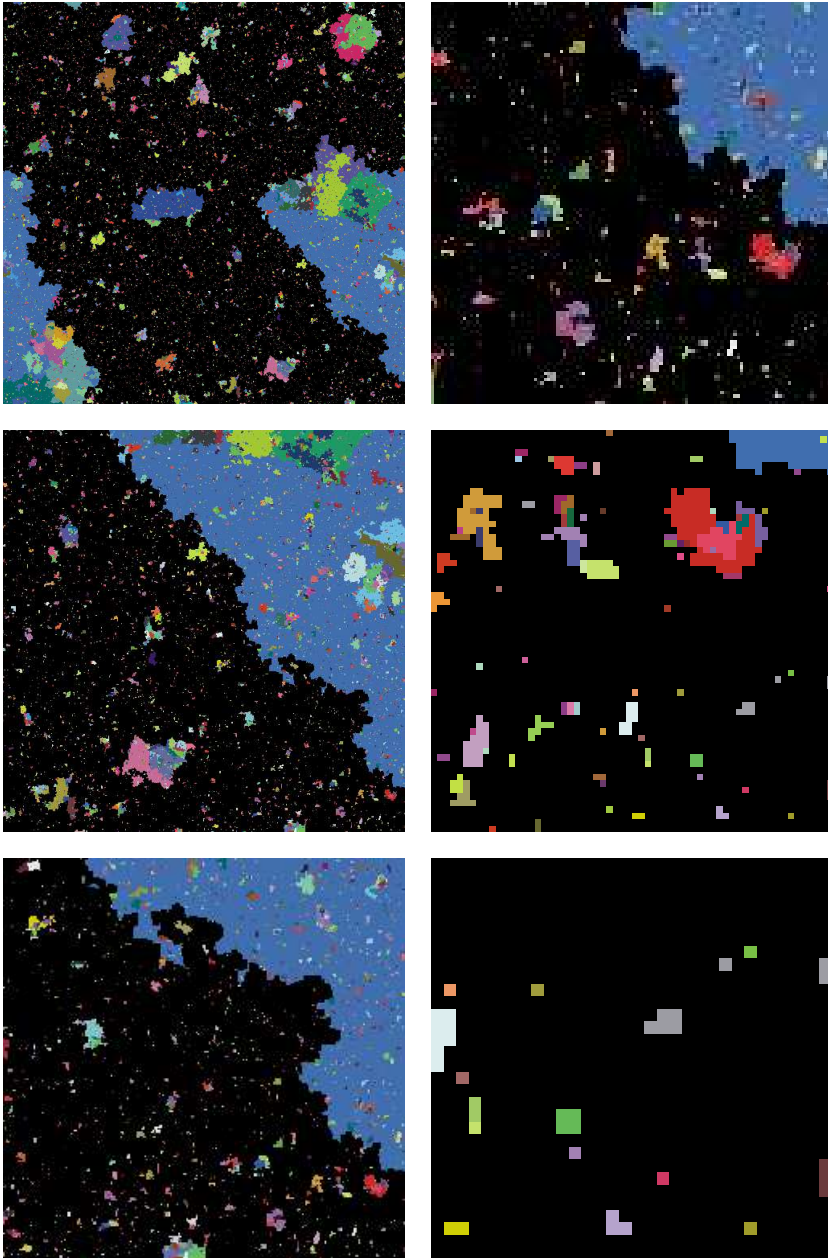
## 12.2 Scale invariance

The other striking feature of continuous phase transitions is the common occurrence of self-similarity, or scale invariance. We can see this vividly in the snapshots of the critical point in the Ising model (Fig. 12.1), percolation (Fig. 12.2), and the avalanche in the hysteresis model (Fig. 12.5). Each shows roughness, irregularities, and holes on all scales at the critical point. This roughness and fractal-looking structure stems at root from a hidden symmetry in the problem: these systems are (statistically) invariant under a change in *length scale*.

Consider Figs 2.2 and 12.11, depicting the self-similarity in a random walk and a cross-section of the avalanches in the hysteresis model. In each set, the upper-left figure shows a large system, and each succeeding picture zooms in by another factor of two. In the hysteresis model, all the figures show a large avalanche spanning the system (black), with a variety of smaller avalanches of various sizes, each with the same kind of irregular boundary (Fig. 12.5). If you blur your eyes a bit, the figures should look roughly alike. This rescaling and eye-blurring process is the renormalization-group coarse-graining transformation. Figure 12.9 shows one tangible rule sometimes used to implement this coarse-graining operation, applied repeatedly to a snapshot of the Ising model at  $T_c$ . Again, the correlations and fluctuations look the same after coarse-graining; the Ising model at  $T_c$  is statistically self-similar.

This scale invariance can be thought of as an emergent symmetry under changes of length scale. In a system invariant under translations, the expectation of any function of two positions  $x_1, x_2$  can be written in terms of the separation between the two points  $\langle g(x_1, x_2) \rangle = \mathcal{G}(x_2 - x_1)$ . In just the same way, scale invariance will allow us to write functions of  $N$  variables in terms of *scaling functions* of  $N - 1$  variables—except that these scaling functions are typically multiplied by power laws in one of the variables.

Let us begin with the case of functions of one variable. Consider the



**Fig. 12.11 Avalanches: scale invariance.** Magnifications of a cross-section of all the avalanches in a run of our hysteresis model (Exercises 8.13 and 12.13) each one the lower right-hand quarter of the previous. The system started with a billion domains ( $1000^3$ ). Each avalanche is shown in a different shade. Again, the larger scales look statistically the same.

avalanche size distribution  $D(S)$  for a model, say the real earthquakes in Fig. 12.3(a), or our model for hysteresis, at the critical point. Imagine taking the same system, but increasing the units of length with which we measure the system—stepping back, blurring our eyes, and looking at the system on a coarse-grained level. Imagine that we multiply the spacing between markings on our rulers by a small amount  $B = 1 + \epsilon$ . After coarsening, any length scales in the problem (like the correlation length  $\xi$ ) will be divided by  $B$ . The avalanche sizes  $S$  after coarse-graining will also be smaller by some factor<sup>10</sup>  $C = 1 + c\epsilon$ . Finally, the overall scale of  $D(S)$  after coarse-graining will be rescaled by some factor  $A = 1 + a\epsilon$ .<sup>11</sup> Hence under the coarse-graining we have

$$\begin{aligned} \xi' &= \xi/B = \xi/(1 + \epsilon), \\ S' &= S/C = S/(1 + c\epsilon), \\ D' &= AD = D(1 + a\epsilon). \end{aligned} \tag{12.3}$$

Now the probability that the coarse-grained system has an avalanche of size  $S'$  is given by the rescaled probability that the original system had an avalanche of size  $S = (1 + c\epsilon)S'$ :

$$D'(S') = AD(S) = AD(CS') = (1 + a\epsilon)D((1 + c\epsilon)S'). \tag{12.4}$$

Here  $D'(S')$  is the distribution measured with the new ruler: a smaller avalanche with a larger probability density. Because we are at a self-similar critical point, the coarse-grained distribution  $D'(S')$  should equal  $D(S')$ . Making  $\epsilon$  infinitesimal leads us to a differential equation:

$$\begin{aligned} D(S') &= D'(S') = (1 + a\epsilon)D((1 + c\epsilon)S'), \\ 0 &= a\epsilon D + c\epsilon S' \frac{dD}{dS}, \\ \frac{dD}{dS} &= -\frac{aD}{cS}, \end{aligned} \tag{12.5}$$

which has the general solution<sup>12</sup>

$$D = D_0 S^{-a/c}. \tag{12.6}$$

Because the properties shared in a universality class only hold up to overall scales, the constant  $D_0$  is system dependent. However, the exponents  $a$ ,  $c$ , and  $a/c$  are *universal*—independent of experiment (with the universality class). Some of these exponents have standard names: the exponent  $c$  giving the fractal dimension of the avalanche is usually called  $d_f$  or  $1/\sigma\nu$ . The exponent  $a/c$  giving the size distribution law is called  $\tau$  in percolation and in most models of avalanches in magnets<sup>13</sup> and is related to the Gutenberg–Richter exponent for earthquakes<sup>14</sup> (Fig. 12.3(b)).

Most measured quantities depending on one variable will have similar power-law singularities at the critical point. Thus the correlation function of the Ising model at  $T_c$  (Fig. 10.4) decays with distance  $x$  in

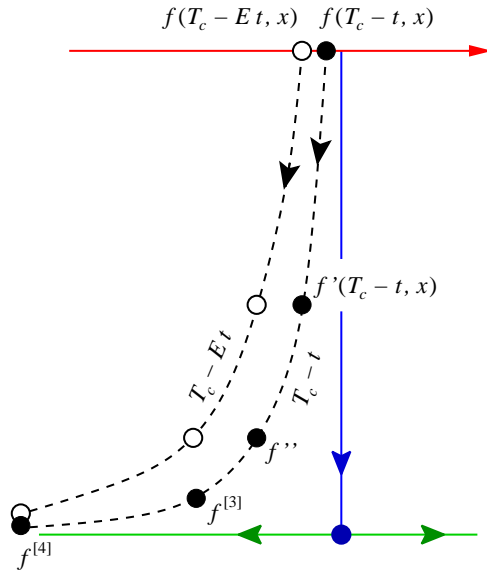
<sup>10</sup>If the size of the avalanche were the cube of its length, then  $c$  would equal 3 since  $(1 + \epsilon)^3 = 1 + 3\epsilon + O(\epsilon^2)$ . Here  $c$  is the fractal dimension of the avalanche.

<sup>11</sup>The same avalanches occur independent of your measuring instrument, but the probability density  $D(S)$  changes, because the fraction of large avalanches depends upon how many small avalanches you measure, and because the fraction per unit  $S$  changes as the scale of  $S$  changes.

<sup>12</sup>Since  $\int dD/D = -a/c \int dS/S$ ,  $\log D = K - (a/c) \log S$  for some integration constant  $K = \log D_0$ .

<sup>13</sup>Except ours, where we used  $\tau$  to denote the avalanche size law at the critical field and disorder; integrated over the hysteresis loop  $D_{\text{int}} \propto S^{-\bar{\tau}}$  with  $\bar{\tau} = \tau + \sigma\beta\delta$ .

<sup>14</sup>We must not pretend that we have found the final explanation for the Gutenberg–Richter law. There are many different models that give exponents  $\approx 2/3$ , but it remains controversial which of these, if any, are correct for real-world earthquakes.



**Fig. 12.12 Scaling near criticality.** If two points in system space flow towards one another under coarse-graining, their behavior must be similar on long length scales. Here we measure a function  $f(x)$  for our system (top line) at two different temperatures,  $T_c - t$  and  $T_c - Et$ . The dots represent successive coarse-grainings by a factor  $B$ ; under this renormalization group  $f \rightarrow f' \rightarrow f'' \rightarrow f^{[3]} \dots$ . Here  $f(T_c - t, x)$  after four coarse-grainings maps to nearly the same system as  $f(T_c - Et, x)$  after three coarse-grainings. We thus know, on long length scales, that  $f'(T_c - t, x)$  must agree with  $f(T_c - Et, x)$ ; the system is similar to itself at a different set of external parameters. In particular, each coarse-graining step changes  $x$  by a factor  $B$  and  $f$  by some factor  $A$ , so  $f'(T_c - t, y) = Af(T_c - t, By) = f(T_c - Et, y)$  for large distances  $y$ .

dimension  $d$  as  $C(x) \propto x^{-(d-2+\eta)}$  and the distance versus time for random walks (Section 2.1) grows as  $t^{1/2}$ , both because these systems are self-similar.<sup>15</sup>

Self-similarity is also expected near to the critical point. Here as one coarsens the length scale a system will be statistically similar to itself at a different set of parameters. Thus a system undergoing phase separation (Section 11.4.1, Exercise 12.3), when coarsened, is similar to itself at an earlier time (when the domains were smaller), and a percolation cluster just above  $p_c$  (Fig. 12.2 (bottom left)) when coarsened is similar to one generated further from  $p_c$  (hence with smaller holes).

For a magnet slightly below<sup>16</sup>  $T_c$ , a system coarsened by a factor  $B = 1 + \epsilon$  will be similar to one farther from  $T_c$  by a factor  $E = 1 + e\epsilon$ . Here the standard Greek letter for the length rescaling exponent is  $\nu = 1/e$  (Fig. 12.12). Similar to the case of the avalanche size distribution, the coarsened system must have its magnetization rescaled upward by  $F = (1 + f\epsilon)$  (with  $f = \beta/\nu$ ) to match that of the lower-temperature original magnet (Fig. 12.12):

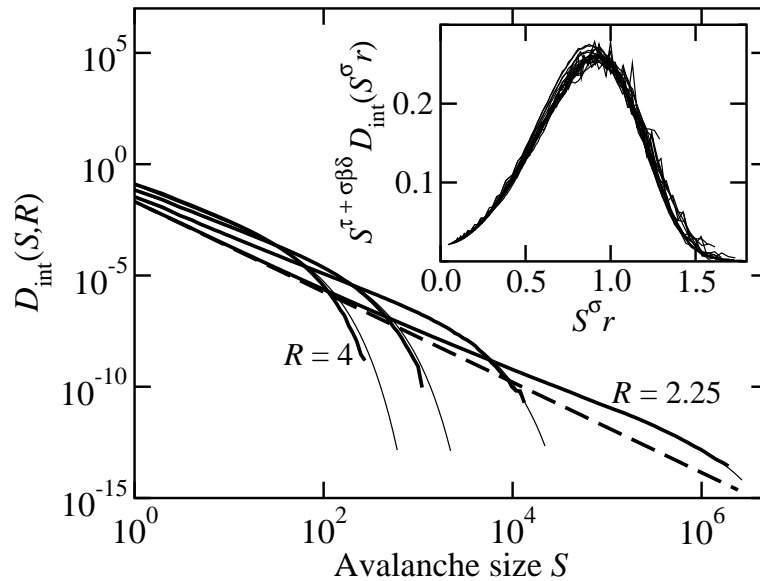
$$\begin{aligned} M'(T_c - t) &= FM(T_c - t) = M(T_c - Et), \\ (1 + f\epsilon)M(T_c - t) &= M(T_c - t(1 + e\epsilon)). \end{aligned} \tag{12.7}$$

Again, taking  $\epsilon$  infinitesimal leads us to the conclusion that  $M \propto t^{f/e} = t^\beta$ , providing a rationale for the power laws we saw in magnetism and the liquid-gas transition (Fig. 12.6). Similarly, the specific heat, correlation length, correlation time, susceptibility, and surface tension of an equilibrium system will have power-law divergences  $(T - T_c)^{-X}$ , where by definition  $X$  is  $\alpha$ ,  $\nu$ ,  $z\nu$ ,  $\gamma$ , and  $-2\nu$ , respectively. One can also

<sup>15</sup>This is because power laws are the only self-similar function. If  $f(x) = x^{-\alpha}$ , then on a new scale multiplying  $x$  by  $B$ ,  $f(Bx) = B^{-\alpha}x^{-\alpha} \propto f(x)$ . (See [97] for more on power laws.)

<sup>16</sup>Thus increasing the distance  $t$  to  $T_c$  decreases the temperature  $T$ .

**Fig. 12.13 Avalanche size distribution.** The distribution of avalanche sizes in our model for hysteresis. Notice the logarithmic scales. (We can measure a  $D(S)$  value of  $10^{-14}$  by running billions of spins and binning over ranges  $\Delta S \sim 10^5$ .) (i) Although only at  $R_c \approx 2.16$  do we get a pure power law (dashed line,  $D(S) \propto S^{-\tau}$ ), we have large avalanches with hundreds of spins even a factor of two away from the critical point. (ii) The curves have the wrong slope except very close to the critical point; be warned that a power law over two decades (although often publishable [84]) may not yield a reliable exponent. (iii) The scaling curves (thin lines) work well even far from  $R_c$ . Inset: We plot  $D(S)/S^{-\tau}$  versus  $S^\sigma(R - R_c)/R$  to extract the universal scaling curve  $\mathcal{D}(X)$  (eqn 12.14). Varying the critical exponents and  $R_c$  to get a good collapse allows us to measure the exponents far from  $R_c$ , where power-law fits are still unreliable (Exercise 12.12(g)).



vary the field  $H$  away from the critical point and measure the resulting magnetization, which varies as  $H^{1/\delta}$ .

To specialists in critical phenomena, these exponents are central; whole conversations often rotate around various combinations of Greek letters. We know how to calculate critical exponents from the various analytical approaches,<sup>17</sup> and they are simple to measure (although hard to measure well, [84]).

Critical exponents are not everything, however. Many other scaling predictions are easily extracted from numerical simulations. Universality should extend even to those properties that we have not been able to write formulae for. In particular, there are an abundance of functions of two and more variables that one can measure. Figure 12.13 shows the distribution of avalanche sizes  $D_{\text{int}}(S, R)$  in our model of hysteresis, integrated over the hysteresis loop (Fig. 8.15), at various disorders  $R$  above  $R_c$  (Exercise 8.13). Notice that only at  $R_c \approx 2.16$  do we get a power-law distribution of avalanche sizes; at larger disorders there are extra small avalanches, and a strong decrease in the number of avalanches beyond a certain size  $S_{\text{max}}(R)$ .

Let us derive the scaling form for  $D_{\text{int}}(S, R)$ . By using scale invariance, we will be able to write this function of two variables as a power of one of the variables times a universal, one-variable function of a combined *scaling variable*. From our treatment at  $R_c$  (eqns 12.3) we know that

$$\begin{aligned} S' &= S/(1 + c\epsilon), \\ D' &= D(1 + a\epsilon). \end{aligned} \tag{12.8}$$

<sup>17</sup>They can be derived from the eigenvalues of the linearization of the renormalization-group flow around the fixed-point  $S^*$  in Fig. 12.8 (see Exercises 12.7 and 12.11).



A system at  $R = R_c + r$  after coarse-graining will be similar to a system further from the critical disorder, at  $R = R_c + Er = R_c + (1 + e\epsilon)r$ , so

$$\begin{aligned} D(S', R_c + Er) &= D'(S', R_c + r) = AD(CS', R_c + r), \\ D(S', R_c + (1 + e\epsilon)r) &= (1 + a\epsilon) D((1 + c\epsilon)S', R_c + r). \end{aligned} \tag{12.9}$$

To facilitate deriving the scaling form for multiparameter functions, it is helpful to change coordinates to the scaling variables. Consider the combination  $X = S^{e/c}r$ . After coarse-graining  $S' = S/C$  and shifting to the higher disorder  $r' = Er$  this combination is unchanged:

$$\begin{aligned} X' = S'^{e/c}r' &= (S/C)^{e/c}(Er) = (S/(1 + c\epsilon))^{e/c}((1 + e\epsilon)r) \\ &= S^{e/c}r \left( \frac{1 + e\epsilon}{(1 + c\epsilon)^{e/c}} \right) = S^{e/c}r + O(\epsilon^2) = X + O(\epsilon^2). \end{aligned} \tag{12.10}$$

Let  $\bar{D}(S, X) = D(S, R)$  be the size distribution as a function of  $S$  and  $X$ . Then  $\bar{D}$  coarse-grains much like a function of one variable, since  $X$  stays fixed. Equation 12.9 now becomes

$$\bar{D}(S', X') = \bar{D}(S', X) = (1 + a\epsilon) \bar{D}((1 + c\epsilon)S', X), \tag{12.11}$$

so

$$a\bar{D} = -cS' \frac{\partial \bar{D}}{\partial S'} \tag{12.12}$$

and hence

$$\bar{D}(S, X) = S^{-a/c} \mathcal{D}(X) = S^{-\bar{\tau}} \mathcal{D}(X) \tag{12.13}$$

for some *scaling function*  $\mathcal{D}(X)$ . This function corresponds to the (non-universal) constant  $D_0$  in eqn 12.6, except here the scaling function is another universal prediction of the theory (up to an overall choice of units for  $X$  and  $D$ ). Rewriting things in terms of the original variables and the traditional Greek names for the scaling exponents ( $c = 1/\sigma\nu$ ,  $a = \bar{\tau}/\sigma\nu$ , and  $e = 1/\nu$ ), we find the scaling form for the avalanche size distribution:

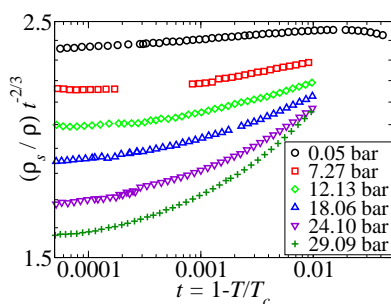
$$D(S, R) \propto S^{-\bar{\tau}} \mathcal{D}(S^\sigma(R - R_c)). \tag{12.14}$$

We can use a *scaling collapse* of the experimental or numerical data to extract this universal function, by plotting  $D/S^{-\bar{\tau}}$  against  $X = S^\sigma(R - R_c)$ ; the inset of Fig. 12.13 shows this scaling collapse.

Similar universal scaling functions appear in many contexts. Considering just the equilibrium Ising model, there are scaling functions for the magnetization  $M(H, T) = (T_c - T)^\beta \mathcal{M}(H/(T_c - T)^{\beta\delta})$ , for the correlation function  $C(x, t, T) = x^{-(d-2+\eta)} \mathcal{C}(x/|T - T_c|^{-\nu}, t/|T - T_c|^{-z\nu})$ , and for finite-size effects  $M(T, L) = (T_c - T)^\beta \mathcal{M}(L/(T_c - T)^{-\nu})$  in a system confined to a box of size  $L^d$ .

### 12.3 Examples of critical points

Ideas from statistical mechanics have found broad applicability in sciences and intellectual endeavors far from their roots in equilibrium ther-



**Fig. 12.14 Superfluid density in helium: scaling plot.** This classic experiment [1, 53] in 1980 measured the superfluid density  $\rho_s(T)$  in helium to great precision. Notice the logarithmic scale on the horizontal axis; the lowest pressure data (saturated vapor pressure  $\approx 0.0504$  bar) spans three decades of temperature shift from  $T_c$ . This plot emphasizes the deviations from the expected power law.

<sup>18</sup>Potts models are Ising-like models with  $N$  states per site rather than two.

mal systems. The scaling and renormalization-group methods introduced in this chapter have seen a particularly broad range of applications; we will touch upon a few in this conclusion to our text.

### 12.3.1 Equilibrium criticality: energy versus entropy

Scaling and renormalization-group methods have their roots in the study of continuous phase transitions in equilibrium systems. Ising models, Potts models,<sup>18</sup> Heisenberg models, phase transitions in liquid crystals, wetting transitions, equilibrium crystal shapes (Fig. 11.6), two-dimensional melting—these are the grindstones on which our renormalization-group tools were sharpened.

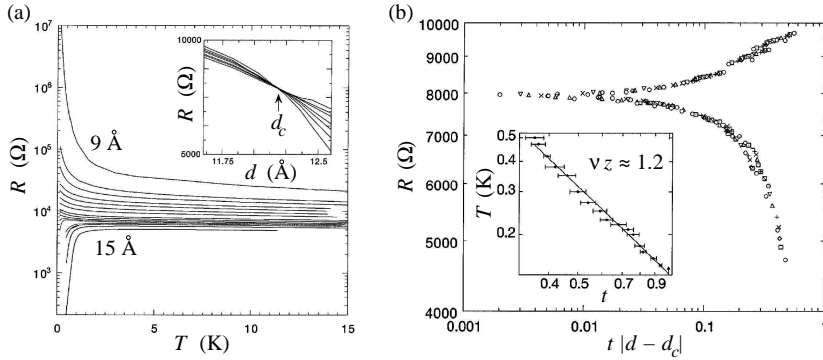
The transition in all of these systems represents the competition between energy and entropy, with energy favoring order at low temperatures and entropy destroying it at high temperatures. Figure 12.14 shows the results of a classic, amazing experiment—the analysis of the superfluid transition in helium (the same order parameter, and also the same universality class, as the XY model). The superfluid density is expected to have the form

$$\rho_s \propto (T_c - T)^\beta (1 + d(T_c - T)^x), \quad (12.15)$$

where  $x$  is a universal, subdominant *correction to scaling*. Since  $\beta \approx \frac{2}{3}$ , they plot  $\rho_s / (T - T_c)^{2/3}$  so that deviations from the simple expectation are highlighted. The slope in the top, roughly straight curve reflects the difference between their measured value of  $\beta = 0.6749 \pm 0.0007$  and their multiplier  $\frac{2}{3}$ . The other curves show the effects of the subdominant correction, whose magnitude  $d$  increases with increasing pressure. Recent experiments improving on these results were done on the space station, in order to reduce the effects of gravity.

### 12.3.2 Quantum criticality: zero-point fluctuations versus energy

Thermal fluctuations do not exist at zero temperature, but there are many well-studied *quantum phase transitions* which arise from the competition of potential energy and quantum fluctuations. Many of the earliest studies focused on the metal–insulator transition and the phenomenon of *localization*, where disorder can lead to insulators even when there are states at the Fermi surface. Scaling and renormalization-group methods played a central role in this early work; for example, the states near the *mobility edge* (separating localized from extended states) are self-similar and fractal. Other milestones include the Kondo effect, macroscopic quantum coherence (testing the fundamentals of quantum measurement theory), transitions between quantum Hall plateaus, and superconductor–normal metal transitions. Figure 12.15 show a recent experiment studying a transition directly from a superconductor to an



**Fig. 12.15 The superconductor–insulator transition.** (a) Thin films of amorphous bismuth are insulators (resistance grows to infinity at zero temperature), while films above about 12 Å are superconducting (resistance goes to zero at a temperature above zero). (b) Scaling collapse. Resistance plotted against the scaled thickness for the superconductor–insulator transition, with each thickness rescaled by an independent factor  $t$  to get a good collapse. The top scaling curve  $\mathcal{F}_-$  is for the insulators  $d < d_c$ , and the bottom one  $\mathcal{F}_+$  is for the superconductors  $d > d_c$ . The inset shows  $t \sim T^{-1/\nu z}$ , with  $\nu z \sim 1.2$ . (From [87].)

insulator, as the thickness of a film is varied. The resistance is expected to have the scaling form

$$R(d, T) = R_c \mathcal{F}_{\pm} \left( (d - d_c) T^{-1/\nu z} \right); \quad (12.16)$$

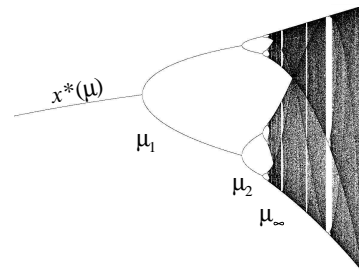
the authors plot  $R(d, T)$  versus  $t(d - d_c)$ , vary  $t$  until the curves collapse (main part of Fig. 12.15(b)), and read off  $1/\nu z$  from the plot of  $t$  versus  $T$  (inset). While it is clear that scaling and renormalization-group ideas are applicable to this problem, we should note that as of the time this text was written, no theory yet convincingly explains these particular observations.

### 12.3.3 Dynamical systems and the onset of chaos

Much of statistical mechanics focuses on systems with large numbers of particles, or systems connected to a large external environment. Continuous transitions also arise in isolated or simply driven systems with only a few important degrees of freedom, where they are called *bifurcations*. A bifurcation is a qualitative change in behavior which arises when a parameter in a set of differential equations passes through a critical value. The study of these bifurcations is the theory of *normal forms* (Exercise 12.4). Bifurcation theory contains analogies to universality classes, critical exponents, and analytic corrections to scaling.

Dynamical systems, even when they contain only a few degrees of freedom, can exhibit immensely complex, chaotic behavior. The mathematical trajectories formed by chaotic systems at late times—the *attractors*—are often fractal in structure, and many concepts and methods from statistical mechanics are useful in studying these sets.<sup>19</sup>

It is in the study of the onset of chaos where renormalization-group methods have had a spectacular impact. Figure 12.16 shows a simple dynamical system undergoing a series of bifurcations leading to a chaotic state. Feigenbaum (Exercise 12.9) analyzed the series using a renormalization group, coarse-graining not in space but in *time*. Again,



**Fig. 12.16 Self-similarity at the onset of chaos.** The attractor as a function of  $\mu$  for the Feigenbaum logistic map  $f(x) = 4\mu x(1 - x)$ . For small  $\mu < \mu_1$ , repeatedly iterating  $f$  converges to a fixed-point  $x^*(\mu)$ . As  $\mu$  is raised past  $\mu_1$ , the map converges into a two-cycle; then a four-cycle at  $\mu_2$ , an eight-cycle at  $\mu_3$ ... These period-doubling bifurcations converge geometrically:  $\mu_{\infty} - \mu_n \propto \delta^{-n}$  where  $\delta = 4.669201609102990 \dots$  is a universal constant. At  $\mu_{\infty}$  the system goes chaotic. (Exercise 12.9).

<sup>19</sup>For example, statistical mechanical ensembles become *invariant measures* (Exercise 4.3), and the attractors are characterized using concepts related to entropy (Exercise 5.16).

this behavior is universal—exactly the same series of bifurcations (up to smooth coordinate changes) arise in other maps and in real physical systems. Other renormalization-group calculations have been important for the study of the transition to chaos from quasiperiodic motion, and for the breakdown of the last non-chaotic region in Hamiltonian systems (see Exercise 4.4).

### 12.3.4 Glassy systems: random but frozen

Let us conclude with a common continuous transition for which our understanding remains incomplete: glass transitions.

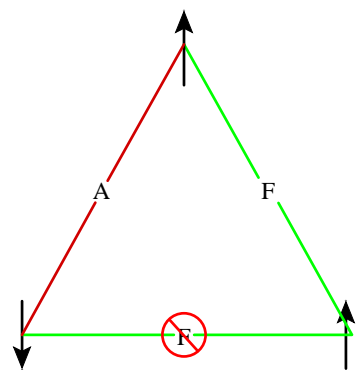
Glasses are out of equilibrium; their relaxation times diverge as they are cooled, and they stop rearranging at a typical temperature known as the glass transition temperature. Many other disordered systems also appear to be glassy, in that their relaxation times get very slow as they are cooled, and they freeze into disordered configurations.<sup>20</sup> This freezing process is sometimes described as developing *long-range order in time*, or as a *broken ergodicity* (see Section 4.2).

The basic reason that many of the glassy systems freeze into random states is *frustration*. Frustration was defined first for spin glasses, which are formed by randomly substituting magnetic atoms into a non-magnetic host. The magnetic spins are coupled to one another at random; some pairs prefer to be parallel (ferromagnetic couplings) and some antiparallel (antiferromagnetic). Whenever strongly-interacting spins form a loop with an odd number of antiferromagnetic bonds (Fig. 12.17) they are frustrated; one of the bonds will have to be left in an unhappy state, since there must be an even number of spin inversions around the loop (Fig. 12.17). It is believed in many cases that frustration is also important for configurational glasses (Fig. 12.18).

The study of disordered magnetic systems is mathematically and computationally sophisticated. The equilibrium ground state for the three-dimensional random-field Ising model,<sup>21</sup> for example, has been rigorously proven to be ferromagnetic (boring); nonetheless, when cooled in zero external field we understand why it freezes into a disordered state, because the coarsening process develops diverging free energy barriers to relaxation. Methods developed to study the spin glass transition have seen important applications in neural networks (which show a forgetting transition as the memory becomes overloaded) and more recently in guiding algorithms for solving computationally hard (NP-complete) problems (see Exercises 1.8 and 8.15). Some basic conceptual questions, however, remain unanswered. For example, we still do not know whether spin glasses have a finite or infinite number of equilibrium states—whether, upon infinitely slow cooling, one still has many glassy configurations.<sup>22</sup>

In real configurational glasses the viscosity and relaxation times grow by ten to fifteen orders of magnitude in a relatively small temperature range, until the cooling rate out-paces the equilibration. We fundamentally do not know why the viscosity diverges so rapidly in so many materials. There are at least three competing pictures for the glass tran-

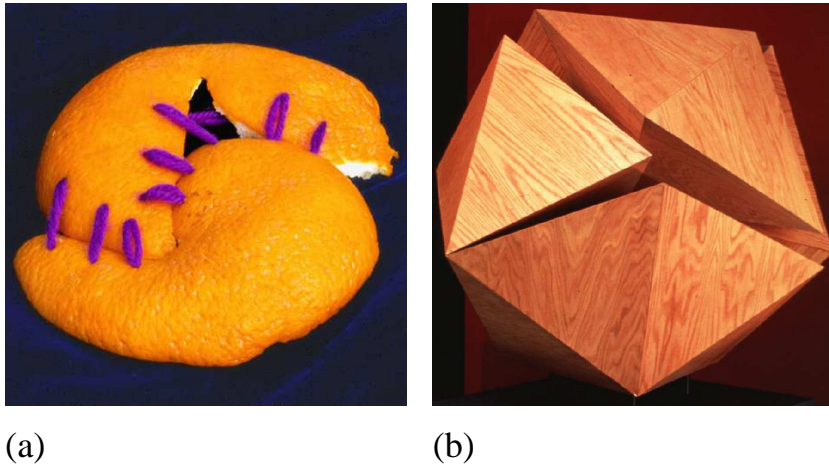
<sup>20</sup>Glasses are different from disordered systems. The randomness in disordered systems is fixed, and occurs in both the high- and low-temperature phases; the disorder in the traditional *configurational* glasses freezes in as it cools. See also Section 5.2.2.



**Fig. 12.17 Frustration.** A spin glass has a collection of magnetic ions with interactions of random sign. Here we see a triangle of Ising  $\pm 1$  spins with one antiferromagnetic bond—one of the three bonds must be unsatisfied in any spin configuration. Hence the system is said to be *frustrated*.

<sup>21</sup>Our model for hysteresis and avalanches (Figs 8.18, 12.5, 12.11, and 12.13; Exercises 8.13, 8.14, and 12.13) is this same random-field Ising model, but in a growing external field and out of equilibrium.

<sup>22</sup>There are ‘cluster’ theories which assume two (spin-flipped) ground states, competing with ‘replica’ and ‘cavity’ methods applied to infinite-range models which suggest many competing ground states. Some rigorous results are known.



**Fig. 12.18 Frustration and curvature.** One kind of frustration arises when the energetically favorable local packing of atoms or molecules is incompatible with the demands of building large structures. Here we show two artistic renditions (courtesy of Pamela Davis Kivelson [67]). (a) The classic problem faced by map-makers: the peel of an orange (or the crust of the Earth) cannot be mapped smoothly onto a flat space without stretching and tearing it. (b) The analogous problem faced in many metallic glasses, whose atoms locally prefer to form nice compact tetrahedra: twenty tetrahedra cannot be glued together to form an icosahedron. Just as the orange peel segments can be nicely fit together on the sphere, the metallic glasses are unfrustrated in curved space [117].

sition. (1) It reflects an underlying equilibrium transition to an ideal, zero-entropy glass state, which would be formed under infinitely slow cooling. (2) It is a purely dynamical transition (where the atoms or molecules jam together). (3) It is not a transition at all, but just a cross-over where the liquid viscosity jumps rapidly (say, because of the formation of semipermanent covalent bonds).

### 12.3.5 Perspectives

Many of the physicists who read this text will spend their careers outside of traditional physics. Physicists continue to play significant roles in the financial world (econophysics, computational finance, derivative trading), in biology (bioinformatics, models of ecology and evolution), computer science (traffic models, algorithms for solving hard problems), and to some extent in social science modeling (models of voting behavior and consensus building). The tools and methods of statistical mechanics (particularly the scaling methods used to study continuous transitions) are perhaps the most useful tools that we bring to these disparate subjects. Conversely, I hope that this text will prove useful as an introduction of these tools and methods to computer scientists, biologists, engineers, and finance professionals, as they continue to broaden and fertilize the field of statistical mechanics.

## Exercises

We start by re-emphasizing the phenomena and conventions used in studying continuous phase transitions in *Ising self-similarity*, *Scaling functions*, and *Scaling and coarsening*. We study solvable critical points in *Bifurcation theory*, *Mean-field theory* and *The onset of lasing*. We illustrate how the renormalization-group flows determine the critical behavior in *Renormalization-group trajectories* and *Superconductivity and the renormalization group*; the latter explains schematically the fundamental basis for Fermi liquid theory. *Period doubling* and the two versions of *The renormalization-group and the central limit theorem* provide important applications where the reader may implement the renormalization group explicitly and completely. We conclude with two numerical exercises, *Percolation and universality* and *Hysteresis and avalanches: scaling*, which mimic the entire experimental analysis from data collection to critical exponents and scaling functions.

(12.1) **Ising self-similarity.** ①

Start up the Ising model (computer exercises portion of the book web site [129]). Run a large system at zero external field and  $T = T_c = 2/\log(1 + \sqrt{2}) \approx 2.26919$ . Set the refresh rate low enough that graphics is not the bottle-neck, and run for at least a few hundred sweeps to equilibrate. You should see a fairly self-similar structure, with fractal-looking up-spin clusters inside larger down-spin structures inside ...  
*Can you find a nested chain of three clusters? Four?*

(12.2) **Scaling and corrections to scaling.** (Condensed matter) ②

Near critical points, the self-similarity under rescaling leads to characteristic power-law singularities. These dependences may be disguised, however, by less-singular corrections to scaling.

An experiment measures the susceptibility  $\chi(T)$  in a magnet for temperatures  $T$  slightly above the ferromagnetic transition temperature  $T_c$ . They find their data is fit well by the form

$$\chi(T) = A(T - T_c)^{-1.25} + B + C(T - T_c) + D(T - T_c)^{1.77}. \quad (12.17)$$

(a) *Assuming this is the correct dependence near  $T_c$ , what is the critical exponent  $\gamma$ ?*

When measuring functions of two variables near critical points, one finds universal scaling functions. The whole function is a prediction of the theory.

The pair correlation function  $C(r, T) = \langle S(x)S(x+r) \rangle$  is measured in another, three-dimensional system just above  $T_c$ . It is found to be spherically symmetric, and of the form

$$C(r, T) = r^{-1.026} \mathcal{C}(r(T - T_c)^{0.65}), \quad (12.18)$$

where the function  $\mathcal{C}(x)$  is found to be roughly  $\exp(-x)$ .

(b) *What is the critical exponent  $\nu$ ? The exponent  $\eta$ ?*

(12.3) **Scaling and coarsening.** (Condensed matter) ③

During coarsening, we found that the system changed with time, with a length scale that grows as a power of time:  $L(t) \sim t^{1/2}$  for a non-conserved order parameter, and  $L(t) \sim t^{1/3}$  for a conserved order parameter. These exponents, unlike critical exponents, are simple rational numbers that can be derived from arguments akin to dimensional analysis (Section 11.4.1). Associated with these diverging length scales there are scaling functions. Coarsening does not lead to a system which is self-similar to itself at equal times, but it does lead to a system which at two different times looks the same—apart from a shift of length scales.

An Ising model with non-conserved magnetization is quenched to a temperature  $T$  well below  $T_c$ . After a long time  $t_0$ , the correlation function looks like  $C_{t_0}^{\text{coar}}(\mathbf{r}, T) = c(\mathbf{r})$ .

*Assume that the correlation function at short distances  $C_t^{\text{coar}}(\mathbf{0}, T, t)$  will be time independent, and that the correlation function at later times will have the same functional form apart from a rescaling of the length. Write the correlation function at time twice  $t_0$ ,  $C_{2t_0}^{\text{coar}}(\mathbf{r}, T)$ , in terms of  $c(\mathbf{r})$ . Write a scaling form*

$$C_t^{\text{coar}}(\mathbf{r}, T) = t^{-\omega} \mathcal{C}(\mathbf{r}/t^\rho, T). \quad (12.19)$$

*Use the time independence of  $C_t^{\text{coar}}(\mathbf{0}, T)$  and the fact that the order parameter is not con-*

served (Section 11.4.1) to predict the numerical values of the exponents  $\omega$  and  $\rho$ .

It was only recently made clear that the scaling function  $\mathcal{C}$  for coarsening *does* depend on temperature (and is, in particular, anisotropic for low temperature, with domain walls lining up with lattice planes). Low-temperature coarsening is not as ‘universal’ as continuous phase transitions are (Section 11.4.1); even in one model, different temperatures have different scaling functions.

(12.4) **Bifurcation theory.** (Mathematics) ③

Dynamical systems theory is the study of the time evolution given by systems of differential equations. Let  $\mathbf{x}(t)$  be a vector of variables evolving in time  $t$ , let  $\boldsymbol{\lambda}$  be a vector of parameters governing the differential equation, and let  $\mathbf{F}_\lambda(\mathbf{x})$  be the differential equations

$$\dot{\mathbf{x}} \equiv \frac{\partial \mathbf{x}}{\partial t} = \mathbf{F}_\lambda(\mathbf{x}). \quad (12.20)$$

The typical focus of the theory is not to solve the differential equations for general initial conditions, but to study the qualitative behavior. In general, they focus on *bifurcations*—special values of the parameters  $\boldsymbol{\lambda}$  where the behavior of the system changes qualitatively.

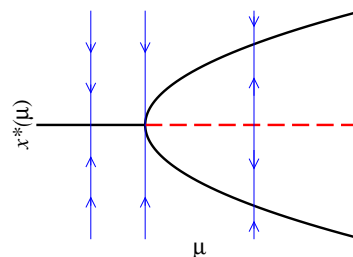
(a) Consider the differential equation in one variable  $x(t)$  with one parameter  $\mu$ :

$$\dot{x} = \mu x - x^3. \quad (12.21)$$

Show that there is a bifurcation at  $\mu_c = 0$ , by showing that an initial condition with small, non-zero  $x(0)$  will evolve qualitatively differently at late times for  $\mu > 0$  versus for  $\mu < 0$ . Hint: Although you can solve this differential equation explicitly, we recommend instead that you argue this qualitatively from the bifurcation diagram in Fig. 12.19; a few words should suffice.

Dynamical systems theory has much in common with equilibrium statistical mechanics of phases and phase transitions. The liquid–gas transition is characterized by external parameters  $\boldsymbol{\lambda} = (P, T, N)$ , and has a current state described by  $\mathbf{x} = (V, E, \mu)$ . Equilibrium phases correspond to fixed-points ( $x^*(\mu)$  with  $\dot{x}^* = 0$ ) in the dynamics, and phase transitions correspond to bifurcations.<sup>23</sup> For example, the

power laws we find near continuous phase transitions have simpler analogues in the dynamical systems.



**Fig. 12.19 Pitchfork bifurcation diagram.** The flow diagram for the pitchfork bifurcation (eqn 12.21). The dashed line represents unstable fixed-points, and the solid thick lines represent stable fixed-points. The thin lines and arrows represent the dynamical evolution directions. It is called a pitchfork because of the three tines on the right emerging from the handle on the left.

(b) Find the critical exponent  $\beta$  for the pitchfork bifurcation, defined by  $x^*(\mu) \propto (\mu - \mu_c)^\beta$  as  $\mu \rightarrow \mu_c$ .

Bifurcation theory also predicts universal behavior; all pitchfork bifurcations have the same scaling behavior near the transition.

(c) At what value  $\lambda_c$  does the differential equation

$$\dot{m} = \tanh(\lambda m) - m \quad (12.22)$$

have a bifurcation? Does the fixed-point value  $m^*(\lambda)$  behave as a power law  $m^* \sim |\lambda - \lambda_c|^\beta$  near  $\lambda_c$  (up to corrections with higher powers of  $\lambda - \lambda_c$ )? Does the value of  $\beta$  agree with that of the pitchfork bifurcation in eqn 12.21?

Just as there are different universality classes for continuous phase transitions with different renormalization-group fixed points, there are different classes of bifurcations each with its own *normal form*. Some of the other important normal forms include the saddle-node bifurcation,

$$\dot{x} = \mu - x^2, \quad (12.23)$$

transcritical exchange of stability,

$$\dot{x} = \mu x - x^2, \quad (12.24)$$

<sup>23</sup>In Section 8.3, we noted that inside a phase all properties are analytic in the parameters. Similarly, bifurcations are values of  $\lambda$  where non-analyticities in the long-time dynamics are observed.

and the Hopf bifurcation,

$$\begin{aligned} \dot{x} &= (\mu - (x^2 + y^2))x - y, \\ \dot{y} &= (\mu - (x^2 + y^2))y + x. \end{aligned} \tag{12.25}$$

(12.5) **Mean-field theory.** (Condensed matter) ③

In Chapter 11 and Exercise 9.5, we make reference to mean-field theories, a term which is often loosely used for any theory which absorbs the fluctuations of the order parameter field into a single degree of freedom in an effective free energy. The original mean-field theory actually used the mean value of the field on neighboring sites to approximate their effects.

In the Ising model on a square lattice, this amounts to assuming each spin  $s_j = \pm 1$  has four neighbors which are magnetized with the average magnetization  $m = \langle s_j \rangle$ , leading to a one-spin mean-field Hamiltonian

$$\mathcal{H} = -4Jms_j. \tag{12.26}$$

(a) At temperature  $k_B T$ , what is the value for  $\langle s_j \rangle$  in eqn 12.26, given  $m$ ? At what temperature  $T_c$  is the phase transition, in mean field theory? (Hint: At what temperature is a non-zero  $m = \langle s \rangle$  self-consistent?) Argue as in Exercise 12.4 part (c) that  $m \propto (T_c - T)^\beta$  near  $T_c$ . Is this value for the critical exponent  $\beta$  correct for the Ising model in either two dimensions ( $\beta = 1/8$ ) or three dimensions ( $\beta \approx 0.325$ )?

(b) Show that the mean-field solution you found in part (a) is the minimum in an effective temperature-dependent free energy

$$\begin{aligned} V(m) &= k_B T \left( \frac{m^2}{2} \right. \\ &\quad \left. - \log(\cosh(4Jm/k_B T)) \frac{k_B T}{4J} \right). \end{aligned} \tag{12.27}$$

On a single graph, plot  $V(m)$  for  $1/(k_B T) = 0.1, 0.25, \text{ and } 0.5$ , for  $-2 < m < 2$ , showing the continuous phase transition. Compare with Fig. 9.22.

(c) What would the mean-field Hamiltonian be for the square-lattice Ising model in an external

field  $H$ ? Show that the mean-field magnetization is given by the minima in<sup>24</sup>

$$\begin{aligned} V(m) &= k_B T \left( \frac{m^2}{2} \right. \\ &\quad \left. - \log(\cosh((H + 4Jm)/k_B T)) \frac{k_B T}{4J} \right). \end{aligned} \tag{12.28}$$

On a single graph, plot  $V(m, H)$  for  $\beta = 0.5$  and  $H = 0, 0.5, 1.0, \text{ and } 1.5$ , showing metastability and an abrupt transition. At what value of  $H$  does the metastable state become completely unstable? Compare with Fig. 11.2(a).

(12.6) **The onset of lasing.**<sup>25</sup> (Quantum, Optics, Mathematics) ③

Lasers represent a stationary, condensed state. It is different from a phase of matter not only because it is made up out of energy, but also because it is intrinsically a non-equilibrium state. In a laser entropy is not maximized, free energies are not minimized—and yet the state has a robustness and integrity reminiscent of phases in equilibrium systems.

In this exercise, we will study a system of excited atoms coupled to a photon mode just before it begins to lase. We will see that it exhibits the diverging fluctuations and scaling that we have studied near critical points.

Let us consider a system of atoms weakly coupled to a photon mode. We assume that  $N_1$  atoms are in a state with energy  $E_1$ ,  $N_2$  atoms are in a higher energy  $E_2$ , and that these atoms are strongly coupled to some environment that keeps these populations fixed.<sup>26</sup> Below the onset of lasing, the probability  $\rho_n(t)$  that the photon mode is occupied by  $n$  photons obeys

$$\begin{aligned} \frac{d\rho_n}{dt} &= a(n\rho_{n-1}N_2 - n\rho_nN_1 - (n+1)\rho_nN_2 \\ &\quad + (n+1)\rho_{n+1}N_1). \end{aligned} \tag{12.29}$$

The first term on the right-hand side represents the rate at which one of the  $N_2$  excited atoms experiencing  $n - 1$  photons will emit a photon; the second term represents the rate at which one of the  $N_1$  lower-energy atoms will absorb one of  $n$  photons; the third term represents emission in an environment with  $n$  photons, and

<sup>24</sup>One must admit that it is a bit weird to have the external field  $H$  inside the effective potential, rather than coupled linearly to  $m$  outside.

<sup>25</sup>This exercise was developed with the help of Alex Gaeta and Al Sievers.

<sup>26</sup>That is, we assume that the atoms are being pumped into state  $N_2$  to compensate for both decays into our photon mode and decays into other channels. This usually involves exciting atoms into additional atomic levels.



the last represents absorption with  $n + 1$  photons. The fact that absorption in the presence of  $m$  photons is proportional to  $m$  and emission is proportional to  $m + 1$  is a property of bosons (Exercises 7.8(c) and 7.9). The constant  $a > 0$  depends on the lifetime of the transition, and is related to the Einstein  $A$  coefficient (Exercise 7.8).

(a) Find a simple expression for  $d\langle n \rangle / dt$ , where  $\langle n \rangle = \sum_{m=0}^{\infty} m \rho_m$  is the mean number of photons in the mode. (Hint: Collect all terms involving  $\rho_m$ .) Show for  $N_2 > N_1$  that this mean number grows indefinitely with time, leading to a macroscopic occupation of photons into this single state—a laser.<sup>27</sup>

Now, let us consider our system just before it begins to lase. Let  $\epsilon = (N_2 - N_1)/N_1$  be our measure of how close we are to the lasing instability. We might expect the value of  $\langle n \rangle$  to diverge as  $\epsilon \rightarrow 0$  like  $\epsilon^{-\nu}$  for small  $\epsilon$ . Near a phase transition, one also normally observes *critical slowing-down*: to equilibrate, the phase must communicate information over large distances of the order of the correlation length, which takes a time which diverges as the correlation length diverges. Let us define a critical-slowing-down exponent  $\zeta$  for our lasing system, where the typical relaxation time is proportional to  $|\epsilon|^{-\zeta}$  as  $\epsilon \rightarrow 0$ .

(b) For  $\epsilon < 0$ , below the instability, solve your equation from part (a) for the long-time stationary value of  $\langle n \rangle$ . What is  $\nu$  for our system? For a general initial condition for the mean number of photons, solve for the time evolution. It should decay to the long-time value exponentially. Does the relaxation time diverge as  $\epsilon \rightarrow 0$ ? What is  $\zeta$ ?

(c) Solve for the stationary state  $\rho^*$  for  $N_2 < N_1$ . (Your formula for  $\rho_n^*$  should not involve  $\rho^*$ .) If  $N_2/N_1$  is given by a Boltzmann probability at temperature  $T$ , is  $\rho^*$  the thermal equilibrium distribution for the quantum harmonic oscillator at that temperature? Warning: The number of bosons in a phonon mode is given by the Bose–Einstein distribution, but the probability of different occupations in a quantum harmonic oscillator is given by the Boltzmann distribution (see Section 7.2 and Exercise 7.2). We might expect that near the instability the probability of getting  $n$  photons might have a

scaling form

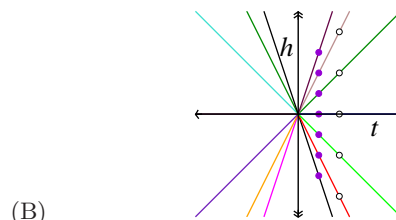
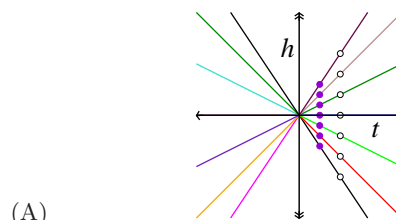
$$\rho_n^*(\epsilon) \sim n^{-\tau} \mathcal{D}(n|\epsilon|^\nu). \quad (12.30)$$

(d) Show for small  $\epsilon$  that there is a scaling form for  $\rho^*$ , with corrections that go to zero as  $\epsilon \rightarrow 0$ , using your answer to part (c). What is  $\tau$ ? What is the function  $\mathcal{D}(x)$ ? (Hint: In deriving the form of  $\mathcal{D}$ ,  $\epsilon$  is small, but  $n\epsilon^\nu$  is of order one. If you were an experimentalist doing scaling collapses, you would plot  $n^\tau \rho_n$  versus  $x = n|\epsilon|^{-\nu}$ ; try changing variables in  $n^\tau \rho_n$  to replace  $\epsilon$  by  $x$ , and choose  $\tau$  to eliminate  $n$  for small  $\epsilon$ .)

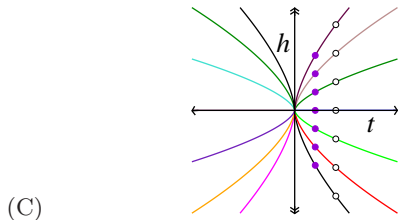
(12.7) **Renormalization-group trajectories.** ③

An Ising model near its critical temperature  $T_c$  is described by two variables: the distance to the critical temperature  $t = (T - T_c)/T_c$ , and the external field  $h = H/J$ . Under a coarse-graining of length  $x' = (1 - \epsilon)x$ , the system is observed to be similar to itself at a shifted temperature  $t' = (1 + a\epsilon)t$  and a shifted external field  $h' = (1 + b\epsilon)h$ , with  $b > a > 0$  (so there are two relevant eigendirections, with the external field more strongly relevant than the temperature).

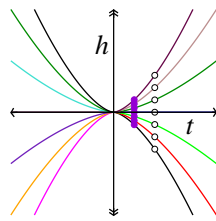
(a) Which diagram below has curves consistent with this flow, for  $b > a > 0$ ?



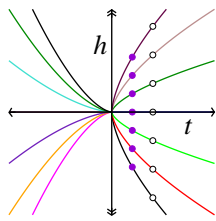
<sup>27</sup>The number of photons will eventually stop growing when they begin to pull energy out of the  $N_2$  excited atoms faster than the pumping can replace them—invalidate our equations.



(C)



(D)



(E)

The magnetization  $M(t, h)$  is observed to rescale under this same coarse-graining operation to  $M' = (1 + c\epsilon)M$ , so  $M((1 + a\epsilon)t, (1 + b\epsilon)h) = (1 + c\epsilon)M(t, h)$ .

(b) Suppose  $M(t, h)$  is known at  $t = t_1$ , the line of filled circles in the various figures in part (a). Give a formula for  $M(2t_1, h)$  (open circles) in terms of  $M(t_1, h')$ . (Hint: Find the scaling variable in terms of  $t$  and  $h$  which is constant along the renormalization-group trajectories shown in (a). Write a scaling form for  $M(t, h)$  in terms of this scaling variable, and find the critical exponents in terms of  $a, b$ , and  $c$ . Then calculating  $M(t, h)$  at  $t = 2t_1$  should be possible, given the values at  $t = t_1$ .)

(12.8) **Superconductivity and the renormalization group.** (Condensed matter) ③

Ordinary superconductivity happens at a rather low temperature; in contrast to phonon energies (hundreds of degrees Kelvin times  $k_B$ ) or electronic energies (tens of thousands of de-

grees Kelvin), phonon-mediated superconductivity in most materials happens below a few Kelvin. This is largely explained by the BCS theory of superconductivity, which predicts that the transition temperature for weakly-coupled superconductors is

$$T_c = 1.764 \hbar\omega_D \exp(-1/Vg(\epsilon_F)), \quad (12.31)$$

where  $\omega_D$  is a characteristic phonon frequency,  $V$  is an attraction between electron pairs mediated by the phonons, and  $g(\epsilon_F)$  is the density of states (DOS) of the electron gas (eqn 7.74) at the Fermi energy. If  $V$  is small,  $\exp(-1/Vg(\epsilon_F))$  can be exponentially small, explaining why materials often have to be so cold to go superconducting.

Superconductivity was discovered decades before it was explained. Many looked for explanations which would involve interactions with phonons, but there was a serious obstacle. People had studied the interactions of phonons with electrons, and had shown that the system stays metallic (no superconductivity) *to all orders in perturbation theory*.

(a) Taylor expand  $T_c$  (eqn 12.31) about  $V = 0^+$  (about infinitesimal positive  $V$ ). Guess the value of all the terms in the Taylor series. Can we expect to explain superconductivity at positive temperatures by perturbing in powers of  $V$ ?

There are two messages here.

- Proving something to all orders in perturbation theory does not make it true.
- Since phases are regions in which perturbation theory converges (see Section 8.3), the theorem is not a surprise. It is a condition for a metallic phase with a Fermi surface to exist at all.

In recent times, people have developed a renormalization-group description of the Fermi liquid state and its instabilities<sup>28</sup> (see note 23 on p. 144). Discussing Fermi liquid theory, the BCS theory of superconductivity, or this renormalization-group description would take us far into rather technical subjects. However, we can illustrate all three by analyzing a rather unusual renormalization-group flow.

Roughly speaking, the renormalization-group treatment of Fermi liquids says that the Fermi

<sup>28</sup>There are also other instabilities of Fermi liquids. Charge-density waves, for example, also have the characteristic  $\exp(-1/aV)$  dependence on the coupling  $V$ .

surface is a fixed-point of a coarse-graining in *energy*. That is, they start with a system space consisting of a partially-filled band of electrons with an energy width  $W$ , including all kinds of possible electron–electron repulsions and attractions. They coarse-grain by perturbatively eliminating (integrating out) the electronic states near the edges of the band,

$$W' = (1 - \delta)W, \quad (12.32)$$

incorporating their interactions and effects into altered interaction strengths among the remaining electrons. These altered interactions give the renormalization-group flow in the system space. The equation for  $W$  gives the change under one iteration ( $n = 1$ ); we can pretend  $n$  is a continuous variable and take  $\delta n \rightarrow 0$ , so  $(W' - W)/\delta \rightarrow dW/dn$ , and hence

$$dW/dn = -W. \quad (12.33)$$

When they do this calculation, they find the following.

- The non-interacting Fermi gas we studied in Section 7.7 is a *fixed point of the renormalization group*. All interactions are zero at this fixed-point. Let  $V$  represent one of these interactions.<sup>29</sup>
- The fixed-point is unstable to an attractive interaction  $V > 0$ , but is stable to a repulsive interaction  $V < 0$ .
- Attractive forces between electrons grow under coarse-graining and lead to new phases, but repulsive forces shrink under coarse-graining, leading back to the metallic free Fermi gas.

This is quite different from our renormalization-group treatment of phase transitions, where *relevant* directions like the temperature and field were unstable under coarse-graining, whether shifted up or down from the fixed-point, and other directions were *irrelevant* and stable (Fig. 12.8). For example, the temperature of our Fermi gas is a relevant variable, which rescales under coarse-graining like

$$T' = (1 + a\delta)T, \quad dT/dn = aT. \quad (12.34)$$

Here  $a > 0$ , so the effective temperature becomes larger as the system is coarse-grained.

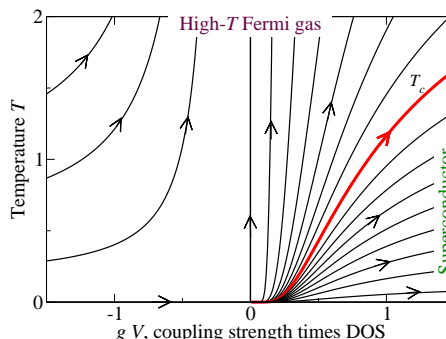
How can they get a variable  $V$  which grows for  $V > 0$  and shrinks for  $V < 0$ ?

- When they do the coarse-graining, they find that the interaction  $V$  is *marginal*: to linear order it neither increases nor decreases.

The next allowed term in the Taylor series near the fixed-point gives us the coarse-grained equation for the interaction:

$$V' = (1 + b\delta V)V, \quad dV/dn = bV^2. \quad (12.35)$$

- They find  $b > 0$ .



**Fig. 12.20 Fermi liquid theory renormalization-group flows.** The renormalization flows defined by eqns 12.34 and 12.35. The temperature  $T$  is relevant at the free Fermi gas fixed-point; the coupling  $V$  is marginal. The distinguished curve represents a phase transition boundary  $T_c(V)$ . Below  $T_c$ , for example, the system is superconducting; above  $T_c$  it is a (finite-temperature) metal.

- (b) True or false? (See Fig. 12.20.)
- (T) (F) For  $V > 0$  (attractive interactions), the interactions get stronger with coarse-graining.
  - (T) (F) For  $V < 0$  (repulsive interactions), coarse-graining leads us back to the free Fermi gas, explaining why the Fermi gas describes metals (Section 7.7).
  - (T) (F) Temperature is an irrelevant variable, but dangerous.

<sup>29</sup> $V$  will be the pairing between opposite-spin electrons near the Fermi surface for superconductors.

(T) (F) The scaling variable

$$x = TV^{1/\beta\delta} \tag{12.36}$$

is unchanged by the coarse-graining (second equations in 12.34 and 12.35), where  $\beta$  and  $\delta$  are universal critical exponents;<sup>30</sup> hence  $x$  labels the progress along the curves in Fig. 12.20 (increasing in the direction of the arrows).

(T) (F) The scaling variable

$$y = T \exp(a/(bV)) \tag{12.37}$$

is unchanged by the coarse-graining, so each curve in Fig. 12.20 has a fixed value for  $y$ .

Now, without knowing anything about superconductivity, let us presume that our system goes superconducting at some temperature  $T_c(V)$  when the interactions are attractive. When we coarse-grain a system that is at the superconducting transition temperature, we must get another system that is at its superconducting transition temperature.

(c) What value for  $a/b$  must they calculate in order to get the BCS transition temperature (eqn 12.31) from this renormalization group? What is the value of the scaling variable (whichever you found in part (b)) along  $T_c(V)$ ?

Thus the form of the BCS transition temperature at small  $V$ , eqn 12.31, can be explained by studying the Fermi gas *without reference to the superconducting phase!*

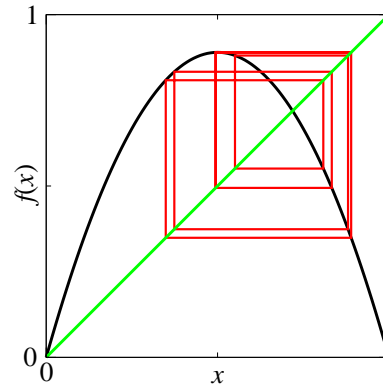
(12.9) **Period doubling.**<sup>31</sup> (Mathematics, Complexity) ④

In this exercise, we use renormalization-group and scaling methods to study the onset of chaos. There are several routes by which a dynamical system can start exhibiting chaotic motion; this exercise studies the *period-doubling cascade*, first extensively investigated by Feigenbaum.

Chaos is often associated with dynamics which stretch and fold; when a batch of taffy is being pulled, the motion of a speck in the taffy depends sensitively on the initial conditions. A simple representation of this physics is provided by the map<sup>32</sup>

$$f(x) = 4\mu x(1 - x) \tag{12.38}$$

restricted to the domain  $(0, 1)$ . It takes  $f(0) = f(1) = 0$ , and  $f(1/2) = \mu$ . Thus, for  $\mu = 1$  it precisely folds the unit interval in half, and stretches it to cover the original domain.



**Fig. 12.21 Period-eight cycle.** Iterating around the attractor of the Feigenbaum map at  $\mu = 0.89$ .

The study of dynamical systems (e.g., differential equations and maps like eqn 12.38) often focuses on the behavior after long times, where the trajectory moves along the attractor. We can study the onset and behavior of chaos in our system by observing the evolution of the attractor as we change  $\mu$ . For small enough  $\mu$ , all points shrink to the origin; the origin is a stable fixed-point which attracts the entire interval  $x \in (0, 1)$ . For larger  $\mu$ , we first get a stable fixed-point inside the interval, and then *period doubling*.

(a) Iteration: Set  $\mu = 0.2$ ; iterate  $f$  for some initial points  $x_0$  of your choosing, and convince yourself that they all are attracted to zero. Plot  $f$  and the diagonal  $y = x$  on the same plot. Are there any fixed-points other than  $x = 0$ ? Repeat for  $\mu = 0.3$ ,  $\mu = 0.7$ , and  $0.8$ . What happens? On the same graph, plot  $f$ , the diagonal  $y = x$ , and the segments  $\{x_0, x_0\}$ ,  $\{x_0, f(x_0)\}$ ,  $\{f(x_0), f(x_0)\}$ ,  $\{f(x_0), f(f(x_0))\}$ , ... (representing the convergence of the trajectory to the attractor; see Fig. 12.21). See how  $\mu = 0.7$  and  $0.8$  differ. Try other values of  $\mu$ . By iterating the map many times, find a point  $a_0$  on the attractor. As above, then plot the

<sup>30</sup>Note that here  $\delta$  is not the infinitesimal change in parameter.

<sup>31</sup>This exercise and the associated software were developed in collaboration with Christopher Myers.

<sup>32</sup>We also study this map in Exercises 4.3, 5.9, and 5.16; parts (a) and (b) below overlap somewhat with Exercise 4.3.

successive iterates of  $a_0$  for  $\mu = 0.7, 0.8, 0.88, 0.89, 0.9,$  and  $1.0$ .

You can see at higher  $\mu$  that the system no longer settles into a stationary state at long times. The fixed-point where  $f(x) = x$  exists for all  $\mu > 1/4$ , but for larger  $\mu$  it is no longer *stable*. If  $x^*$  is a fixed-point (so  $f(x^*) = x^*$ ) we can add a small perturbation  $f(x^* + \epsilon) \approx f(x^*) + f'(x^*)\epsilon = x^* + f'(x^*)\epsilon$ ; the fixed-point is stable (perturbations die away) if  $|f'(x^*)| < 1$ .<sup>33</sup>

In this particular case, once the fixed-point goes unstable the motion after many iterations becomes periodic, repeating itself after *two* iterations of the map—so  $f(f(x))$  has two new fixed-points. This is called *period doubling*. Notice that by the chain rule  $df(f(x))/dx = f'(x)f'(f(x))$ , and indeed

$$\begin{aligned} \frac{df^{[n]}}{dx} &= \frac{df(f(\dots f(x)\dots))}{dx} & (12.39) \\ &= f'(x)f'(f(x))\dots f'(f(\dots f(x)\dots)), \end{aligned}$$

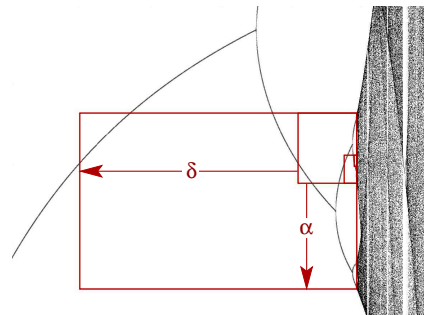
so the stability of a period- $N$  orbit is determined by the product of the derivatives of  $f$  at each point along the orbit.

(b) Analytics: Find the fixed-point  $x^*(\mu)$  of the map 12.38, and show that it exists and is stable for  $1/4 < \mu < 3/4$ . If you are ambitious or have a computer algebra program, show that the period-two cycle is stable for  $3/4 < \mu < (1 + \sqrt{6})/4$ .

(c) Bifurcation diagram: Plot the attractor as a function of  $\mu$ , for  $0 < \mu < 1$ ; compare with Fig. 12.16. (Pick regularly-spaced  $\delta\mu$ , run  $n_{\text{transient}}$  steps, record  $n_{\text{cycles}}$  steps, and plot. After the routine is working, you should be able to push  $n_{\text{transient}}$  and  $n_{\text{cycles}}$  both larger than 100, and  $\delta\mu < 0.01$ .) Also plot the attractor for another one-humped map

$$f_{\sin}(x) = B \sin(\pi x), \quad (12.40)$$

for  $0 < B < 1$ . Do the bifurcation diagrams appear similar to one another?



**Fig. 12.22 Self-similarity in period-doubling bifurcations.** The period doublings occur at geometrically-spaced values of the control parameter  $\mu_\infty - \mu_n \propto \delta^{-n}$ , and the attractor during the period- $2^n$  cycle is similar to one-half of the attractor during the  $2^{n+1}$ -cycle, except inverted and larger, rescaling  $x$  by a factor of  $\alpha$  and  $\mu$  by a factor of  $\delta$ . The boxes shown in the diagram illustrate this self-similarity; each box looks like the next, except expanded by  $\delta$  along the horizontal  $\mu$  axis and flipped and expanded by  $\alpha$  along the vertical axis.

Notice the complex, structured, chaotic region for large  $\mu$  (which we study in Exercise 4.3). How do we get from a stable fixed-point  $\mu < 3/4$  to chaos? The onset of chaos in this system occurs through a cascade of *period doublings*. There is the sequence of bifurcations as  $\mu$  increases—the period-two cycle starting at  $\mu_1 = 3/4$ , followed by a period-four cycle starting at  $\mu_2$ , period-eight at  $\mu_3$ —a whole period-doubling cascade. The convergence appears geometrical, to a fixed-point  $\mu_\infty$ :

$$\mu_n \approx \mu_\infty - A\delta^{-n}, \quad (12.41)$$

so

$$\delta = \lim_{n \rightarrow \infty} (\mu_{n-1} - \mu_{n-2}) / (\mu_n - \mu_{n-1}) \quad (12.42)$$

and there is a similar geometrical self-similarity along the  $x$  axis, with a (negative) scale factor  $\alpha$  relating each generation of the tree (Fig. 12.22). In Exercise 4.3, we explained the boundaries in the chaotic region as images of  $x = 1/2$ . These special points are also convenient for studying period-doubling. Since  $x = 1/2$  is the maximum in the curve,  $f'(1/2) = 0$ . If it were a fixed-point (as it is for  $\mu = 1/2$ ), it would not only

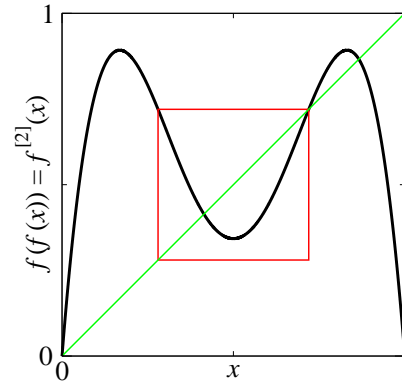
, perturbations die away if the Jacobian of the derivative at the fixed-point has all negative eigenvalues, perturbations die away if all eigenvalues of the Jacobian have magnitude less than one.

be stable, but unusually so: a shift by  $\epsilon$  away from the fixed point converges after one step of the map to a distance  $\epsilon f'(\frac{1}{2}) + \epsilon^2/2f''(\frac{1}{2}) = O(\epsilon^2)$ . We say that such a fixed-point is *superstable*. If we have a period- $N$  orbit that passes through  $x = \frac{1}{2}$ , so that the  $N$ th iterate  $f^N(\frac{1}{2}) \equiv f(\dots f(\frac{1}{2})\dots) = \frac{1}{2}$ , then the orbit is also superstable, since (by eqn 12.39) the derivative of the iterated map is the product of the derivatives along the orbit, and hence is also zero.

These superstable points happen roughly halfway between the period-doubling bifurcations, and are easier to locate, since we know that  $x = \frac{1}{2}$  is on the orbit. Let us use them to investigate the geometrical convergence and self-similarity of the period-doubling bifurcation diagram from part (d). For this part and part (h), you will need a routine that finds the roots  $G(y) = 0$  for functions  $G$  of one variable  $y$ .

(d) The Feigenbaum numbers and universality: Numerically, find the values of  $\mu_n^s$  at which the  $2^n$ -cycle is superstable, for the first few values of  $n$ . (Hint: Define a function  $G(\mu) = f_{\mu}^{[2^n]}(\frac{1}{2}) - \frac{1}{2}$ , and find the root as a function of  $\mu$ . In searching for  $\mu_{n+1}^s$ , you will want to search in a range  $(\mu_n^s + \epsilon, \mu_n^s + (\mu_n^s - \mu_{n-1}^s)/A)$  where  $A \sim 3$  works pretty well. Calculate  $\mu_0$  and  $\mu_1$  by hand.) Calculate the ratios  $(\mu_{n-1}^s - \mu_{n-2}^s)/(\mu_n^s - \mu_{n-1}^s)$ ; do they appear to converge to the Feigenbaum number  $\delta = 4.6692016091029909\dots$ ? Extrapolate the series to  $\mu_{\infty}$  by using your last two reliable values of  $\mu_n^s$  and eqn 12.42. In the superstable orbit with  $2^n$  points, the nearest point to  $x = \frac{1}{2}$  is  $f^{[2^{n-1}]}(\frac{1}{2})$ .<sup>34</sup> Calculate the ratios of the amplitudes  $f^{[2^{n-1}]}(\frac{1}{2}) - \frac{1}{2}$  at successive values of  $n$ ; do they appear to converge to the universal value  $\alpha = -2.50290787509589284\dots$ ? Calculate the same ratios for the map  $f_2(x) = B \sin(\pi x)$ ; do  $\alpha$  and  $\delta$  appear to be universal (independent of the mapping)?

The limits  $\alpha$  and  $\delta$  are independent of the map, so long as it folds (one hump) with a quadratic maximum. They are the same, also, for experimental systems with many degrees of freedom which undergo the period-doubling cascade. This self-similarity and universality suggests that we should look for a renormalization-group explanation.



**Fig. 12.23 Renormalization-group transformation.** The renormalization-group transformation takes  $g(g(x))$  in the small window with upper corner  $x^*$  and inverts and stretches it to fill the whole initial domain and range  $(0, 1) \times (0, 1)$ .

(e) Coarse-graining in time. Plot  $f(f(x))$  vs.  $x$  for  $\mu = 0.8$ , together with the line  $y = x$  (or see Fig. 12.23). Notice that the period-two cycle of  $f$  becomes a pair of stable fixed-points for  $f^{[2]}$ . (We are coarse-graining in time—removing every other point in the time series, by studying  $f(f(x))$  rather than  $f$ .) Compare the plot with that for  $f(x)$  vs.  $x$  for  $\mu = 0.5$ . Notice that the region zoomed in around  $x = \frac{1}{2}$  for  $f^{[2]} = f(f(x))$  looks quite a bit like the entire map  $f$  at the smaller value  $\mu = 0.5$ . Plot  $f^{[4]}(x)$  at  $\mu = 0.875$ ; notice again the small one-humped map near  $x = \frac{1}{2}$ .

The fact that the one-humped map reappears in smaller form just after the period-doubling bifurcation is the basic reason that succeeding bifurcations so often follow one another. The fact that many things are universal is due to the fact that the little one-humped maps have a shape which becomes independent of the original map after several period-doublings.

Let us define this renormalization-group transformation  $T$ , taking function space into itself. Roughly speaking,  $T$  will take the small upside-down hump in  $f(f(x))$  (Fig. 12.23), invert it, and stretch it to cover the interval from  $(0, 1)$ . Notice in your graphs for part (g) that the line  $y = x$  crosses the plot  $f(f(x))$  not only at the two points on the period-two attractor, but also (naturally) at the old fixed-point

<sup>34</sup>This is true because, at the previous superstable orbit,  $2^{n-1}$  iterates returned us to the original point  $x = \frac{1}{2}$ .

$x^*[f]$  for  $f(x)$ . This unstable fixed-point plays the role for  $f^{[2]}$  that the origin played for  $f$ ; our renormalization-group rescaling must map  $(x^*[f], f(x^*)) = (x^*, x^*)$  to the origin. The corner of the window that maps to  $(1, 0)$  is conveniently located at  $1 - x^*$ , since our map happens to be symmetric<sup>35</sup> about  $x = \frac{1}{2}$ . For a general one-humped map  $g(x)$  with fixed-point  $x^*[g]$  the side of the window is thus of length  $2(x^*[g] - \frac{1}{2})$ . To invert and stretch, we must thus rescale by a factor  $\alpha[g] = -1/(2(x^*[g] - \frac{1}{2}))$ . Our renormalization-group transformation is thus a mapping  $T[g]$  taking function space into itself, where

$$T[g](x) = \alpha[g] (g(x/\alpha[g] + x^*[g])) - x^*[g]. \tag{12.43}$$

(This is just rescaling  $x$  to squeeze into the window, applying  $g$  twice, shifting the corner of the window to the origin, and then rescaling by  $\alpha$  to fill the original range  $(0, 1) \times (0, 1)$ .)

(f) Scaling and the renormalization group: Write routines that calculate  $x^*[g]$  and  $\alpha[g]$ , and define the renormalization-group transformation  $T[g]$ . Plot  $T[f]$ ,  $T[T[f]]$ , ... and compare them. Are we approaching a fixed-point  $f^*$  in function space?

This explains the self-similarity; in particular, the value of  $\alpha[g]$  as  $g$  iterates to  $f^*$  becomes the Feigenbaum number  $\alpha = -2.5029\dots$

(g) Universality and the renormalization group: Using the sine function of eqn 12.40, compare  $T[T[f_{\text{sin}}]]$  to  $T[T[f]]$  at their onsets of chaos. Are they approaching the same fixed-point?

By using this rapid convergence in function space, one can prove both that there will (often) be an infinite geometrical series of period-doubling bifurcations leading to chaos, and that this series will share universal features (exponents  $\alpha$  and  $\delta$  and features) that are independent of the original dynamics.

(12.10) **The renormalization group and the central limit theorem: short.** (Mathematics) ④

If you are familiar with the renormalization group and Fourier transforms, this problem can be stated very quickly. If not, you are probably better off doing the long version (Exercise 12.11).

Write a renormalization-group transformation  $T$  taking the space of probability distributions into itself, that takes two random variables, adds them, and rescales the width by the square root of two [28]. Show that the Gaussian of width  $\sigma$  is a fixed-point. Find the eigenfunctions  $f_n$  and eigenvalues  $\lambda_n$  of the linearization of  $T$  at the fixed-point. (Hint: It is easier in Fourier space.) Describe physically what the relevant and marginal eigenfunctions represent. By subtracting the fixed-point distribution from a binomial distribution, find the leading correction to scaling, as a function of  $x$ . Which eigenfunction does it represent? Why is the leading irrelevant eigenvalue not dominant here?

(12.11) **The renormalization group and the central limit theorem: long.** (Mathematics) ④

In this exercise, we will develop a renormalization group in function space to derive the central limit theorem [28]. We will be using maps (like our renormalization transformation  $T$ ) that take a function  $\rho$  of  $x$  into another function of  $x$ ; we will write  $T[\rho]$  as the new function, and  $T[\rho](x)$  as the function evaluated at  $x$ . We will also make use of the Fourier transform (eqn A.6)

$$\mathcal{F}[\rho](k) = \int_{-\infty}^{\infty} e^{-ikx} \rho(x) dx; \tag{12.44}$$

$\mathcal{F}$  maps functions of  $x$  into functions of  $k$ . When convenient, we will also use the tilde notation:  $\tilde{\rho} = \mathcal{F}[\rho]$ , so for example (eqn A.7)

$$\rho(x) = \frac{1}{2\pi} \int_{-\infty}^{\infty} e^{ikx} \tilde{\rho}(k) dk. \tag{12.45}$$

The central limit theorem states that the sum of many independent random variables tends to a Gaussian, whatever the original distribution might have looked like. That is, the Gaussian distribution is the fixed-point function for large sums. When summing many random numbers, the details of the distributions of the individual random variables becomes unimportant; simple behavior emerges. We will study this using the renormalization group, giving an example where we can explicitly implement the coarse-graining transformation. Here our system space is the space of probability distributions  $\rho(x)$ . There are four steps in the procedure.

<sup>35</sup>For asymmetric maps, we would need to locate this other corner  $f(f(x_c)) = x^*$  numerically. As it happens, breaking this symmetry is irrelevant at the fixed-point.

1. *Coarse-grain.* Remove some fraction (usually half) of the degrees of freedom. Here, we will add pairs of random variables; the probability distribution for sums of  $N$  independent random variables of distribution  $f$  is the same as the distribution for sums of  $N/2$  random variables of distribution  $f * f$ , where  $*$  denotes convolution. (a) Argue that if  $\rho(x)$  is the probability that a random variable has value  $x$ , then the probability distribution of the sum of two random variables drawn from this distribution is the convolution

$$C[\rho](x) = (\rho * \rho)(x) = \int_{-\infty}^{\infty} \rho(x - y)\rho(y) dy. \tag{12.46}$$

Remember (eqn A.23) the Fourier transform of the convolution is the product of the Fourier transforms, so

$$\mathcal{F}[C[\rho]](k) = (\tilde{\rho}(k))^2. \tag{12.47}$$

2. *Rescale.* The behavior at larger lengths will typically be similar to that of smaller lengths, but some of the constants will shift (or *renormalize*). Here the mean and width of the distributions will increase as we coarse-grain. We confine our main attention to distributions of zero mean. Remember that the width (standard deviation) of the sum of two random variables drawn from  $\rho$  will be  $\sqrt{2}$  times the width of one variable drawn from  $\rho$ , and that the overall height will have to shrink by  $\sqrt{2}$  to stay normalized. We define a rescaling operator  $S_{\sqrt{2}}$  which reverses this spreading of the probability distribution:

$$S_{\sqrt{2}}[\rho](x) = \sqrt{2}\rho(\sqrt{2}x). \tag{12.48}$$

(b) Show that if  $\rho$  is normalized (integrates to one), so is  $S_{\sqrt{2}}[\rho]$ . Show that the Fourier transform is

$$\mathcal{F}[S_{\sqrt{2}}[\rho]](k) = \tilde{\rho}(k/\sqrt{2}). \tag{12.49}$$

Our renormalization-group transformation is the composition of these two operations,

$$\begin{aligned} T[\rho](x) &= S_{\sqrt{2}}[C[\rho]](x) \\ &= \sqrt{2} \int_{-\infty}^{\infty} \rho(\sqrt{2}x - y)\rho(y) dy. \end{aligned} \tag{12.50}$$

Adding two Gaussian random variables (convolving their distributions) and rescaling the width back should give the original Gaussian distribution; the Gaussian should be a *fixed-point*.

(c) Show that the Gaussian distribution

$$\rho^*(x) = (1/\sqrt{2\pi}\sigma) \exp(-x^2/2\sigma^2) \tag{12.51}$$

is indeed a fixed-point in function space under the operation  $T$ . You can do this either by direct integration, or by using the known properties of the Gaussian under convolution.

(d) Use eqns 12.47 and 12.49 to show that

$$\mathcal{F}[T[\rho]](k) = \tilde{T}[\tilde{\rho}](k) = \tilde{\rho}(k/\sqrt{2})^2. \tag{12.52}$$

Calculate the Fourier transform of the fixed-point  $\tilde{\rho}^*(k)$  (or see Exercise A.4). Using eqn 12.52, show that  $\tilde{\rho}^*(k)$  is a fixed-point in Fourier space under our coarse-graining operator  $\tilde{T}$ .<sup>36</sup>

These properties of  $T$  and  $\rho^*$  should allow you to do most of the rest of the exercise without any messy integrals.

The central limit theorem tells us that sums of random variables have probability distributions that approach Gaussians. In our renormalization-group framework, to prove this we might try to show that our Gaussian fixed-point is *attracting*: that all nearby probability distributions flow under iterations of  $T$  to  $\rho^*$ .

3. *Linearize about the fixed point.* Consider a function near the fixed point:  $\rho(x) = \rho^*(x) + \epsilon f(x)$ . In Fourier space,  $\tilde{\rho}(k) = \tilde{\rho}^*(k) + \epsilon \tilde{f}(k)$ . We want to find the eigenvalues  $\lambda_n$  and eigenfunctions  $f_n$  of the derivative of the mapping  $T$ . That is, they must satisfy

$$\begin{aligned} T[\rho^* + \epsilon f_n] &= \rho^* + \lambda_n \epsilon f_n + O(\epsilon^2), \\ \tilde{T}[\tilde{\rho}^* + \epsilon \tilde{f}_n] &= \tilde{\rho}^* + \lambda_n \epsilon \tilde{f}_n + O(\epsilon^2). \end{aligned} \tag{12.53}$$

(e) Show using eqns 12.52 and 12.53 that the transforms of the eigenfunctions satisfy

$$\tilde{f}_n(k) = (2/\lambda_n)\tilde{\rho}^*(k/\sqrt{2})\tilde{f}_n(k/\sqrt{2}). \tag{12.54}$$

4. Find the eigenvalues and calculate the universal critical exponents.

(f) Show that

$$\tilde{f}_n(k) = (ik)^n \tilde{\rho}^*(k) \tag{12.55}$$

<sup>36</sup>To be explicit, the operator  $\tilde{T} = \mathcal{F} \circ T \circ \mathcal{F}^{-1}$  is a renormalization-group transformation that maps Fourier space into itself.



is the Fourier transform of an eigenfunction (i.e., that it satisfies eqn 12.54.) What is the eigenvalue  $\lambda_n$ ?

Our fixed-point actually does not attract all distributions near it. The directions with eigenvalues greater than one are called *relevant*; they are dangerous, corresponding to deviations from our fixed-point that grow under coarse-graining. The directions with eigenvalues equal to one are called *marginal*; they do not get smaller (to linear order) and are thus also potentially dangerous. When you find relevant and marginal operators, you always need to understand each of them on physical grounds.

(g) The eigenfunction  $f_0(x)$  with the biggest eigenvalue corresponds to an unphysical perturbation; why? (Hint: Probability distributions must be normalized to one.) The next two eigenfunctions  $f_1$  and  $f_2$  have important physical interpretations. Show that  $\rho^* + \epsilon f_1$  to lowest order is equivalent to a shift in the mean of  $\rho$ , and  $\rho^* + \epsilon f_2$  is a shift in the standard deviation  $\sigma$  of  $\rho^*$ .

In this case, the relevant perturbations do not take us to qualitatively new phases—just to other Gaussians with different means and variances. All other eigenfunctions should have eigenvalues  $\lambda_n$  less than one. This means that a perturbation in that direction will shrink under the renormalization-group transformation:

$$T^N(\rho^* + \epsilon f_n) - \rho^* \sim \lambda_n^N \epsilon f_n. \quad (12.56)$$

*Corrections to scaling and coin flips.* Does anything really new come from all this analysis? One nice thing that comes out is the *leading corrections to scaling*. The fixed-point of the renormalization group explains the Gaussian shape of the distribution of  $N$  coin flips in the limit  $N \rightarrow \infty$ , but the linearization about the fixed-point gives a systematic understanding of the corrections to the Gaussian distribution for large but not infinite  $N$ .

Usually, the largest eigenvalues are the ones which dominate. In our problem, consider adding a small perturbation to the fixed-point  $f^*$  along the two leading irrelevant directions  $f_3$  and  $f_4$ :

$$\rho(x) = \rho^*(x) + \epsilon_3 f_3(x) + \epsilon_4 f_4(x). \quad (12.57)$$

These two eigenfunctions can be inverse-transformed from their  $k$ -space form

(eqn 12.55):

$$\begin{aligned} f_3(x) &\propto \rho^*(x)(3x/\sigma - x^3/\sigma^3), \\ f_4(x) &\propto \rho^*(x)(3 - 6x^2/\sigma^2 + x^4/\sigma^4). \end{aligned} \quad (12.58)$$

What happens to these perturbations under multiple applications of our renormalization-group transformation  $T$ ? After  $\ell$  applications (corresponding to adding together  $2^\ell$  of our random variables), the new distribution should be given by

$$T^\ell(\rho)(x) \sim \rho^*(x) + \lambda_3^\ell \epsilon_3 f_3(x) + \lambda_4^\ell \epsilon_4 f_4(x). \quad (12.59)$$

Since  $1 > \lambda_3 > \lambda_4 \dots$ , the leading correction should be dominated by the perturbation with the largest eigenvalue.

(h) Plot the difference between the binomial distribution giving the probability of  $m$  heads in  $N$  coin flips, and a Gaussian of the same mean and width, for  $N = 10$  and  $N = 20$ . (The Gaussian has mean of  $N/2$  and standard deviation  $\sqrt{N}/2$ , as you can extrapolate from the case  $N = 1$ .) Does it approach one of the eigenfunctions  $f_3$  or  $f_4$  (eqns 12.58)?

(i) Why did a perturbation along  $f_3(x)$  not dominate the asymptotics? What symmetry forced  $\epsilon_3 = 0$ ? Should flips of a biased coin break this symmetry?

Using the renormalization group to demonstrate the central limit theorem might not be the most efficient route to the theorem, but it provides quantitative insights into how and why the probability distributions approach the asymptotic Gaussian form.

(12.12) **Percolation and universality.**<sup>37</sup> (Complexity) ④

*Cluster size distribution: power laws at  $p_c$ .* A system at its percolation threshold  $p_c$  is self-similar. When looked at on a longer length scale (say, with a ruler with notches spaced  $1 + \epsilon$  farther apart, for infinitesimal  $\epsilon$ ), the statistical behavior of the large percolation clusters should be unchanged, if we simultaneously rescale various measured properties according to certain rules. Let  $x$  be the length and  $S$

<sup>37</sup>This exercise and the associated software were developed in collaboration with Christopher Myers.

be the size (number of nodes) in a percolation cluster, and let  $n(S)$  be the probability that a given cluster will be of size  $S$  at  $p_c$ .<sup>38</sup> The cluster measured with the new ruler will have a length  $x' = x/(1 - \epsilon)$ , a size  $S' = S/(1 + c\epsilon)$ , and will occur with probability  $n' = (1 + a\epsilon)n$ . (a) *In precise analogy to our analysis of the avalanche size distribution (eqns 12.3–12.6), show that the probability is a power law,  $n(S) \propto S^{-\tau}$ . What is  $\tau$ , in terms of  $a$  and  $c$ ?*

In two dimensions, there are exact results known for many properties of percolation. In particular, it is known that<sup>39</sup>  $\tau = 187/91$ . You can test this numerically, either with the code you developed for Exercise 2.13, or by using the software at our web site [129].

(b) *Calculate the cluster size distribution  $n(S)$ , both for bond percolation on the square lattice and for site percolation on the triangular lattice, for a large system size (perhaps  $L \times L$  with  $L = 400$ ) at  $p = p_c$ .<sup>40</sup> At some moderate size  $S$  you will begin occasionally to not have any avalanches; plot  $\log(n(S))$  versus  $\log(S)$  for both bond and site percolation, together with the power law  $n(S) \propto S^{-187/91}$  predicted by the exact result. To make better use of the data, one should bin the avalanches into larger groups, especially for larger sizes where the data is sparse. It is a bit tricky to do this nicely, and you can get software to do this at our web site [129]. Do the plots again, now with all the data included, using bins that start at size ranges  $1 \leq S < 2$  and grow by a factor of 1.2 for each bin. You should see clear evidence that the distribution of clusters does look like a power law (a straight line on your log–log plot), and fairly convincing evidence that the power law is converging to the exact result at large  $S$  and large system sizes.*

*The size of the infinite cluster: power laws near  $p_c$ .* Much of the physics of percolation above  $p_c$  revolves around the connected piece left after the small clusters fall out, often called the *percolation cluster*. For  $p > p_c$  this largest cluster occupies a fraction of the whole system, often called  $P(p)$ .<sup>41</sup> The fraction of nodes in this

largest cluster for  $p > p_c$  is closely analogous to the  $T < T_c$  magnetization  $M(T)$  in magnets (Fig. 12.6(b)) and the density difference  $\rho_l(T) - \rho_g(T)$  near the liquid–gas critical point (Fig. 12.6(a)). In particular, the value  $P(p)$  goes to zero continuously as  $p \rightarrow p_c$ .

Systems that are not at  $p_c$  are not self-similar. However, there is a scaling relation between systems at differing values of  $p - p_c$ : a system coarsened by a factor  $1 + \epsilon$  will be similar to one farther from  $p_c$  by a factor  $1 + \epsilon/\nu$ , except that the percolation cluster fraction  $P$  must be rescaled upward by  $1 + \beta\epsilon/\nu$ .<sup>42</sup> This last rescaling reflects the fact that the percolation cluster becomes more dense as you coarse-grain, filling in or blurring away the smaller holes. You may check, just as for the magnetization (eqn 12.7), that

$$P(p) \sim (p_c - p)^\beta. \quad (12.60)$$

In two dimensions,  $\beta = 5/36$  and  $\nu = 4/3$ .

(c) *Calculate the fraction of nodes  $P(p)$  in the largest cluster, for both bond and site percolation, at a series of points  $p = p_c + 2^{-n}$  for as large a percolation lattice as is convenient, and a good range of  $n$ . (Once you get your method debugged,  $n = 10$  on an  $L \times L$  lattice with  $L = 200$  should be numerically feasible.) Do a log–log plot of  $P(p)$  versus  $p - p_c$ , and compare along with the theory prediction, eqn 12.60 with  $\beta = 5/36$ .*

You should find that the numerics in part (c) are not compelling, even for rather large system sizes. The two curves look a bit like power laws, but the slopes  $\beta_{\text{eff}}$  on the log–log plot do not agree with one another or with the theory. Worse, as you get close to  $p_c$  the curves, although noisy, definitely are not going to zero. This is natural; there will always be a largest cluster, and it is only as the system size  $L \rightarrow \infty$  that the largest cluster can vanish as a fraction of the system size.

*Finite-size scaling* (advanced). We can extract better values for  $\beta$  from small simulations by

<sup>38</sup>Hence the probability that a given node is in a cluster of size  $S$  is proportional to  $Sn(S)$ .

<sup>39</sup>A non-obvious result!

<sup>40</sup>Conveniently, the critical probability  $p_c = 1/2$  for both these systems, see Exercise 2.13, part(c). This enormously simplifies the scaling analysis, since we do not need to estimate  $p_c$  as well as the critical exponents.

<sup>41</sup>For  $p < p_c$ , there will still be a largest cluster, but it will not grow much bigger as the system size grows and the fraction  $P(p) \rightarrow 0$  for  $p < p_c$  as the system length  $L \rightarrow \infty$ .

<sup>42</sup>We again assure the reader that these particular combinations of Greek letters are just chosen to give the conventional names for the critical exponents.

explicitly including the length  $L$  into our analysis. Let  $P(p, L)$  be the mean fraction of nodes<sup>43</sup> in the largest cluster for a system of size  $L$ .

(d) On a single graph, plot  $P(p, L)$  versus  $p$  for bond percolation  $L = 5, 10, 20, 50,$  and  $100$ , focusing on the region around  $p = p_c$  where they differ from one another. (At  $L = 10$  you will want  $p$  to range from  $0.25$  to  $0.75$ ; for  $L = 50$  the range should be from  $0.45$  to  $0.55$  or so.) Five or ten points will be fine. You will discover that the sample-to-sample variations are large (another finite-size effect), so average each curve over perhaps ten or twenty realizations.

Each curve  $P(p, L)$  is rounded near  $p_c$ , as the characteristic cluster lengths reach the system box length  $L$ . Thus this rounding is itself a symptom of the universal long-distance behavior, and we can study the dependence of the rounding on  $L$  to extract better values of the critical exponent  $\beta$ . We will do this using a *scaling collapse*, rescaling the horizontal and vertical axes so as to make all the curves fall onto a single scaling function.

First, we must derive the scaling function for  $P(p, L)$ . We know that

$$\begin{aligned} L' &= L/(1 + \epsilon), \\ (p_c - p)' &= (1 + \epsilon/\nu)(p_c - p), \end{aligned} \quad (12.61)$$

since the system box length  $L$  rescales like any other length. It is convenient to change variables from  $p$  to  $X = (p_c - p)L^{1/\nu}$ ; let  $P(p, L) = \bar{P}(L, (p_c - p)L^{1/\nu})$ .

(e) Show that  $X$  is unchanged under coarse-graining (eqn 12.61). (You can either show  $X' = X$  up to terms of order  $\epsilon^2$ , or you can show  $dX/d\epsilon = 0$ .)

The combination  $X = (p_c - p)L^{1/\nu}$  is another *scaling variable*. The combination  $\xi = |p - p_c|^{-\nu}$  is the way in which lengths diverge at the critical point, and is called the *correlation length*. Two systems of different lengths and different values of  $p$  should be similar if the lengths are the same when measured in units of  $\xi$ .  $L$  in units of  $\xi$  is  $L/\xi = X^\nu$ , so different systems with the same value of the scaling variable  $X$  are statistically similar. We can turn this verbal assertion into a mathematical

scaling form by studying how  $\bar{P}(L, X)$  coarse-grains.

(f) Using eqns 12.61 and the fact that  $P$  rescales upward by  $(1 + \beta\epsilon/\nu)$  under coarse-graining, write the similarity relationship for  $\bar{P}$  corresponding to eqn 12.11 for  $\bar{D}(S, R)$ . Following our derivation of the scaling form for the avalanche size distribution (through eqn 12.14), show that  $\bar{P}(L, X) = L^{-\beta/\nu}\mathcal{P}(X)$  for some function  $\mathcal{P}(X)$ , and hence

$$P(p, L) \propto L^{-\beta/\nu}\mathcal{P}((p - p_c)L^{1/\nu}). \quad (12.62)$$

Presuming that  $\mathcal{P}(X)$  goes to a finite value as  $X \rightarrow 0$ , derive the power law giving the percolation cluster size  $L^2P(p_c, L)$  as a function of  $L$ . Derive the power-law variation of  $\mathcal{P}(X)$  as  $X \rightarrow \infty$  using the fact that  $P(p, \infty) \propto (p - p_c)^\beta$ .

Now, we can use eqn 12.62 to deduce how to rescale our data. We can find the finite-sized scaling function  $\mathcal{P}$  by plotting  $L^{\beta/\nu}P(p, L)$  versus  $X = (p - p_c)L^{1/\nu}$ , again with  $\nu = 4/3$  and  $\beta = 5/36$ .

(g) Plot  $L^{\beta/\nu}P(p, L)$  versus  $X$  for  $X \in [-0.8, +0.8]$ , plotting perhaps five points for each curve, for both site percolation and bond percolation. Use system sizes  $L = 5, 10, 20,$  and  $50$ . Average over many clusters for the smaller sizes (perhaps 400 for  $L = 5$ ), and over at least ten even for the largest.

Your curves should collapse onto two scaling curves, one for bond percolation and one for site percolation.<sup>44</sup> Notice here that the finite-sized scaling curves collapse well for small  $L$ , while we would need to go to much larger  $L$  to see good power laws in  $P(p)$  directly (part (c)). Notice also that both site percolation and bond percolation collapse for the same value of  $\beta$ , even though the rough power laws from part (c) seemed to differ. In an experiment (or a theory for which exact results were not available), one can use these scaling collapses to estimate  $p_c$ ,  $\beta$ , and  $\nu$ .

<sup>43</sup>You can take a microcanonical-style ensemble over all systems with exactly  $L^2p$  sites or  $2L^2p$  bonds, but it is simpler just to do an ensemble average over random number seeds.

<sup>44</sup>These two curves should also have collapsed onto one another, given a suitable rescaling of the horizontal and vertical axes, had we done the triangular lattice in a square box instead of a rectangular box (which we got from shearing an  $L \times L$  lattice). The finite-size scaling function will in general depend on the boundary condition, and in particular on the shape of the box.

(12.13) **Hysteresis and avalanches: scaling.**  
(Complexity) ③

For this exercise, either download Matt Kuntz's hysteresis simulation code from the book web site [129], or make use of the software you developed in Exercise 8.13 or 8.14.

Run the simulation in two dimensions on a  $1000 \times 1000$  lattice with disorder  $R = 0.9$ , or a three-dimensional simulation on a  $100^3$  lattice at  $R = 2.16$ .<sup>45</sup> The simulation is a simplified model of magnetic hysteresis, described in [128]; see also [127]. The spins  $s_i$  begin all pointing down, and flip upward as the external field  $H$  grows from minus infinity, depending on the spins of their neighbors and a local random field  $h_i$ . The flipped spins are colored as they flip, with spins in the same *avalanche* sharing the same color. An avalanche is a collection of spins which flip together, all triggered from the same original spin. The *disorder* is the ratio  $R$  of the root-mean-square width  $\sqrt{\langle h_i^2 \rangle}$  to the ferromagnetic coupling  $J$  between spins:

$$R = \sqrt{\langle h^2 \rangle} / J. \quad (12.63)$$

Examine the  $M(H)$  curve for our model and the  $dM/dH$  curve. The individual avalanches should be visible on the first graph as jumps, and on the second graph as spikes. This kind of time series (a set of spikes or pulses with a broad range of sizes) we hear as *crackling noise*. You can go to our site [68] to hear the noise resulting from our model, as well as crackling noise we have assembled from crumpling paper, from fires and Rice Krispies<sup>TM</sup>, and from the Earth (earthquakes in 1995, sped up to audio frequencies).

Examine the avalanche size distribution. The (unlabeled) vertical axis on the log-log plot gives the number of avalanches  $D(S, R)$ ; the horizontal axis gives the size  $S$  (with  $S = 1$  on the left-hand side). Equivalently,  $D(S, R)$  is the probability distribution that a given avalanche during the simulation will have size  $S$ . The graph is created as a histogram, and the curve changes color after the first bin with zero entries (after which the data becomes much less useful, and should be ignored).

If available, examine the spin-spin correlation function  $C(x, R)$ . It shows a log-log plot of the

probability (vertical axis) that an avalanche initiated at a point  $\mathbf{x}_0$  will extend to include a spin  $\mathbf{x}_1$  a distance  $x = \sqrt{(\mathbf{x}_1 - \mathbf{x}_0)^2}$  away.

Two dimensions is fun to watch, but the scaling behavior is not yet understood. In three dimensions we have good evidence for scaling and criticality at a phase transition in the dynamical evolution. There is a phase transition in the dynamics at  $R_c \sim 2.16$  on the three-dimensional cubic lattice. Well below  $R_c$  one large avalanche flips most of the spins. Well above  $R_c$  all avalanches are fairly small; at very high disorder each spin flips individually. The critical disorder is the point, as  $L \rightarrow \infty$ , where one first finds *spanning avalanches*, which extend from one side of the simulation to the other.

Simulate a 3D system at  $R = R_c = 2.16$  with  $L = 100$  (one million spins, or larger, if you have a fast machine). It will be fastest if you use the *sorted list* algorithm (Exercise 8.14). The display will show an  $L \times L$  cross-section of the 3D avalanches. Notice that there are many tiny avalanches, and a few large ones. Below  $R_c$  you will find one large colored region forming the background for the others; this is the spanning, or *infinite* avalanche. Look at the  $M(H)$  curve (the bottom half of the hysteresis loop). It has many small vertical jumps (avalanches), and one large one (corresponding to the spanning avalanche).

(a) *What fraction of the system is flipped by the one largest avalanche, in your simulation? Compare this with the hysteresis curve at  $R = 2.4 > R_c$ . Does it have a similar big jump, or is it continuous?*

Below  $R_c$  we get a big jump; above  $R_c$  all avalanches are small compared to the system size. If the system size were large enough, we believe the fraction of spins flipped by the spanning avalanche at  $R_c$  would go to zero. The largest avalanche would nonetheless span the system—just like the percolation cluster at  $p_c$  spans the system but occupies zero volume in the limit of large systems.

The other avalanches form a nice power-law size distribution; let us measure it carefully. Do a

<sup>45</sup>If you are using the brute-force algorithm, you are likely to need to run all of the three-dimensional simulations at a smaller system size, perhaps  $50^3$ . If you have a fast computer, you may wish to run at a larger size, but make sure it is not tedious to watch.

set of 10 runs (*# Runs 10*) at  $L = 100$  and  $R = R_c = 2.16$ .<sup>46</sup>

Watch the avalanches. Notice that sometimes the second-largest avalanche in the view (the largest being the ‘background color’) is sometimes pretty small; this is often because the cross-section we view missed it. Look at the avalanche size distribution. (You can watch it as it averages over simulations.) Print it out when the simulations finish. Notice that at  $R_c$  you find a pretty good power-law distribution (a straight line on the log–log plot). We denote this critical exponent  $\bar{\tau} = \tau + \sigma\beta\delta$ :

$$D(S, R_c) \sim S^{-\bar{\tau}} = S^{-(\tau + \sigma\beta\delta)}. \quad (12.64)$$

(b) *From your plot, measure this exponent combination from your simulation. It should be close to two. Is your estimate larger or smaller than two?*

This power-law distribution is to magnets what the Gutenberg–Richter law (Fig. 12.3(b)) is to earthquakes. The power law stems naturally from the self-similarity.

We want to explore how the avalanche size distribution changes as we move above  $R_c$ . We will do a series of three or four runs at different values of  $R$ , and then graph the avalanche size distributions after various transformations.

Do a run at  $R = 6$  and  $R = 4$  with  $L = 100$ , and make sure your data files are properly output. Do runs at  $R = 3$ ,  $R = 2.5$ , and  $R = 2.16$  at  $L = 200$ .

(c) *Copy and edit your avalanche size distribution files, removing the data after the first bin with zero avalanches in it. Start up a graphics program, and plot the curves on a log–log plot; they should look like power laws for small  $S$ ,*

*and cut off exponentially at larger  $S$ . Enclose a copy of your plot.*

We expect the avalanche size distribution to have the scaling form

$$D(S, R) = S^{-(\tau + \sigma\beta\delta)} \mathcal{D}(S(R - R_c)^{1/\sigma}) \quad (12.65)$$

sufficiently close to  $R_c$ . This reflects the similarity of the system to itself at a different set of parameters; a system at  $2(R - R_c)$  has the same distribution as a system at  $R - R_c$  except for an overall change  $A$  in probability and  $B$  in the size scale of the avalanches, so  $D(S, R - R_c) \approx AD(BS, 2(R - R_c))$ .

(d) *What are  $A$  and  $B$  in this equation for the scaling form given by eqn 12.65?*

At  $R = 4$  and  $6$  we should expect substantial corrections! Let us see how well the collapse works anyhow.

(e) *Multiply the vertical axis of each curve by  $S^{\tau + \sigma\beta\delta}$ . This then should give four curves  $\mathcal{D}(S(R - R_c)^{1/\sigma})$  which are (on a log–log plot) roughly the same shape, just shifted sideways horizontally (rescaled in  $S$  by the typical largest avalanche size, proportional to  $1/(R - R_c)^{1/\sigma}$ ). Measure the peak of each curve. Make a table with columns  $R$ ,  $S_{\text{peak}}$ , and  $R - R_c$  (with  $R_c \sim 2.16$ ). Do a log–log plot of  $R - R_c$  versus  $S_{\text{peak}}$ , and estimate  $\sigma$  in the expected power law  $S_{\text{peak}} \sim (R - R_c)^{-1/\sigma}$ .*

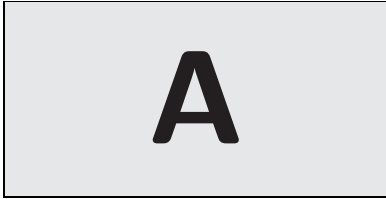
(f) *Do a scaling collapse: plot  $S^{\tau + \sigma\beta\delta} D(S, R)$  versus  $(R - R_c)^{1/\sigma} S$  for the avalanche size distributions with  $R > R_c$ . How well do they collapse onto a single curve?*

The collapses become compelling only near  $R_c$ , where you need very large systems to get good curves.

<sup>46</sup>If your machine is slow, do fewer. If your machine is fast, use a larger system. Make sure you do not run out of RAM, though (lots of noise from your hard disk swapping); if you do, shift to the *bits* algorithm if its available. *Bits* will use much less memory for large simulations, and will start up faster than *sorted list*, but it will take a long time searching for the last few spins. Both are much faster than the brute-force method.



# Appendix: Fourier methods



Why are Fourier methods important? Why is it so useful for us to transform functions of time and space  $y(\mathbf{x}, t)$  into functions of frequency and wavevector  $\tilde{y}(\mathbf{k}, \omega)$ ?

- *Humans hear frequencies.* The human ear analyzes pressure variations in the air into different frequencies. Large frequencies  $\omega$  are perceived as high pitches; small frequencies are low pitches. The ear, very roughly, does a Fourier transform of the pressure  $P(t)$  and transmits  $|\tilde{P}(\omega)|^2$  to the brain.<sup>1</sup>
- *Diffraction experiments measure Fourier components.* Many experimental methods diffract waves (light, X-rays, electrons, or neutrons) off of materials (Section 10.2). These experiments typically probe the absolute square of the Fourier amplitude of whatever is scattering the incoming beam.
- *Common mathematical operations become simpler in Fourier space.* Derivatives, correlation functions, and convolutions can be written as simple products when the functions are Fourier transformed. This has been important to us when calculating correlation functions (eqn 10.4), summing random variables (Exercises 1.2 and 12.11), and calculating susceptibilities (eqns 10.30, 10.39, and 10.53, and Exercise 10.9). In each case, we turn a calculus calculation into algebra.
- *Linear differential equations in translationally-invariant systems have solutions in Fourier space.*<sup>2</sup> We have used Fourier methods for solving the diffusion equation (Section 2.4.1), and more broadly to solve for correlation functions and susceptibilities (Chapter 10).

In Section A.1 we introduce the conventions typically used in physics for the Fourier series, Fourier transform, and fast Fourier transform. In Section A.2 we derive their integral and differential properties. In Section A.3, we interpret the Fourier transform as an orthonormal change-of-basis in function space. And finally, in Section A.4 we explain why Fourier methods are so useful for solving differential equations by exploring their connection to translational symmetry.

## A.1 Fourier conventions

Here we define the Fourier series, the Fourier transform, and the fast Fourier transform, as they are commonly defined in physics and as they are used in this text.

<b>A.1 Fourier conventions</b>	<b>299</b>
<b>A.2 Derivatives, convolutions, and correlations</b>	<b>302</b>
<b>A.3 Fourier methods and function space</b>	<b>303</b>
<b>A.4 Fourier and translational symmetry</b>	<b>305</b>

<sup>1</sup>Actually, this is how the ear *seems* to work, but not how it *does* work. First, the signal to the brain is time dependent, with the tonal information changing as a word or tune progresses; it is more like a wavelet transform, giving the frequency content in various time slices. Second, the phase information in  $\tilde{P}$  is not completely lost; power and pitch are the primary signal, but the relative phases of different pitches are also perceptible. Third, experiments have shown that the human ear is very nonlinear in its mechanical response.

<sup>2</sup>Translation invariance in Hamiltonian systems implies momentum conservation. This is why in quantum mechanics Fourier transforms convert position-space wavefunctions into momentum-space wavefunctions—even for systems which are not translation invariant.

The Fourier series for functions of time, periodic with period  $T$ , is

$$\tilde{y}_m = \frac{1}{T} \int_0^T y(t) \exp(i\omega_m t) dt, \tag{A.1}$$

where  $\omega_m = 2\pi m/T$ , with integer  $m$ . The Fourier series can be re-summed to retrieve the original function using the *inverse Fourier series*:

$$y(t) = \sum_{m=-\infty}^{\infty} \tilde{y}_m \exp(-i\omega_m t). \tag{A.2}$$

Fourier series of functions in space are defined with the *opposite* sign convention<sup>3</sup> in the complex exponentials. Thus in a three-dimensional box of volume  $V = L \times L \times L$  with periodic boundary conditions, these formulæ become

$$\tilde{y}_{\mathbf{k}} = \frac{1}{V} \int y(\mathbf{x}) \exp(-i\mathbf{k} \cdot \mathbf{x}) dV, \tag{A.3}$$

and

$$y(\mathbf{x}) = \sum_{\mathbf{k}} \tilde{y}_{\mathbf{k}} \exp(i\mathbf{k} \cdot \mathbf{x}), \tag{A.4}$$

where the  $\mathbf{k}$  run over a lattice of wavevectors

$$\mathbf{k}_{(m,n,o)} = [2\pi m/L, 2\pi n/L, 2\pi o/L] \tag{A.5}$$

in the box.

The Fourier transform is defined for functions on the entire infinite line:

$$\tilde{y}(\omega) = \int_{-\infty}^{\infty} y(t) \exp(i\omega t) dt, \tag{A.6}$$

where now  $\omega$  takes on all values.<sup>4</sup> We regain the original function by doing the inverse Fourier transform:

$$y(t) = \frac{1}{2\pi} \int_{-\infty}^{\infty} \tilde{y}(\omega) \exp(-i\omega t) d\omega. \tag{A.7}$$

This is related to the inverse Fourier series by a continuum limit (Fig. A.1):

$$\frac{1}{2\pi} \int d\omega \approx \frac{1}{2\pi} \sum_{\omega} \Delta\omega = \frac{1}{2\pi} \sum_{\omega} \frac{2\pi}{T} = \frac{1}{T} \sum, \tag{A.8}$$

where the  $1/T$  here compensates for the factor of  $T$  in the definitions of the forward Fourier series. In three dimensions the Fourier transform formula A.6 is largely unchanged,

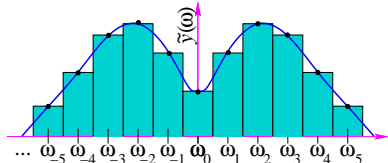
$$\tilde{y}(\mathbf{k}) = \int y(\mathbf{x}) \exp(-i\mathbf{k} \cdot \mathbf{x}) dV, \tag{A.9}$$

while the inverse Fourier transform gets the cube of the prefactor:

$$y(\mathbf{x}) = \frac{1}{(2\pi)^3} \int_{-\infty}^{\infty} \tilde{y}(\mathbf{k}) \exp(i\mathbf{k} \cdot \mathbf{x}) d\mathbf{k}. \tag{A.10}$$

<sup>3</sup>This inconsistent convention allows waves of positive frequency to propagate forward rather than backward. A single component of the inverse transform,  $e^{i\mathbf{k} \cdot \mathbf{x}} e^{-i\omega t} = e^{i(\mathbf{k} \cdot \mathbf{x} - \omega t)}$  propagates in the  $+\mathbf{k}$  direction with speed  $\omega/|\mathbf{k}|$ ; had we used a  $+i$  for Fourier transforms in both space and time  $e^{i(\mathbf{k} \cdot \mathbf{x} + \omega t)}$  would move *backward* (along  $-\mathbf{k}$ ) for  $\omega > 0$ .

<sup>4</sup>Why do we divide by  $T$  or  $L$  for the series and not for the transform? Imagine a system in an extremely large box. Fourier series are used for functions which extend over the entire box; hence we divide by the box size to keep them finite as  $L \rightarrow \infty$ . Fourier transforms are usually used for functions which vanish quickly, so they remain finite as the box size gets large.



**Fig. A.1 Approximating the integral as a sum.** By approximating the integral  $\int \tilde{y}(\omega) \exp(i\omega t) d\omega$  as a sum over the equally-spaced points  $\omega_m$ ,  $\sum_m \tilde{y}(\omega) \exp(i\omega_m t) \Delta\omega$ , we can connect the formula for the Fourier transform to the formula for the Fourier series, explaining the factor  $1/2\pi$  in eqn A.7.



The fast Fourier transform (FFT) starts with  $N$  equally-spaced data points  $y_\ell$ , and returns a new set of complex numbers  $\tilde{y}_m^{\text{FFT}}$ :

$$\tilde{y}_m^{\text{FFT}} = \sum_{\ell=0}^{N-1} y_\ell \exp(i2\pi m\ell/N), \tag{A.11}$$

with  $m = 0, \dots, N - 1$ . The inverse of the FFT is given by

$$y_\ell = \frac{1}{N} \sum_{m=0}^{N-1} \tilde{y}_m^{\text{FFT}} \exp(-i2\pi m\ell/N). \tag{A.12}$$

The FFT essentially samples the function  $y(t)$  at equally-spaced points  $t_\ell = \ell T/N$  for  $\ell = 0, \dots, N - 1$ :

$$\tilde{y}_m^{\text{FFT}} = \sum_{\ell=0}^{N-1} y_\ell \exp(i\omega_m t_\ell). \tag{A.13}$$

It is clear from eqn A.11 that  $\tilde{y}_{m+N}^{\text{FFT}} = \tilde{y}_m^{\text{FFT}}$ , so the fast Fourier transform is periodic with period  $\omega_N = 2\pi N/T$ . The inverse transform can also be written

$$y_\ell = \frac{1}{N} \sum_{m=-N/2+1}^{N/2} \tilde{y}_m^{\text{FFT}} \exp(-i\omega_m t_\ell), \tag{A.14}$$

where we have centered<sup>5</sup> the sum  $\omega_m$  at  $\omega = 0$  by using the periodicity.<sup>6</sup>

Often the values  $y(t)$  (or the data points  $y_\ell$ ) are real. In this case, eqns A.1 and A.6 show that the negative Fourier amplitudes are the complex conjugates of the positive ones:  $\tilde{y}(\omega) = \tilde{y}^*(-\omega)$ . Hence for real functions the real part of the Fourier amplitude will be even and the imaginary part will be odd.<sup>7</sup>

The reader may wonder why there are so many versions of roughly the same Fourier operation.

- (1) The function  $y(t)$  can be defined on a finite interval with periodic boundary conditions on  $(0, T)$  (series, FFT) or defined in all space (transform). In the periodic case, the Fourier coefficients are defined only at discrete wavevectors  $\omega_m = 2\pi m/T$  consistent with the periodicity of the function; in the infinite system the coefficients are defined at all  $\omega$ .
- (2) The function  $y(t)$  can be defined at a discrete set of  $N$  points  $t_n = n\Delta t = nT/N$  (FFT), or at all points  $t$  in the range (series, transform). If the function is defined only at discrete points, the Fourier coefficients are periodic with period  $\omega_N = 2\pi/\Delta t = 2\pi N/T$ .<sup>8</sup>

There are several arbitrary choices made in defining these Fourier methods, that vary from one field to another.

- Some use the notation  $j = \sqrt{-1}$  instead of  $i$ .

<sup>5</sup>If  $N$  is odd, to center the FFT the sum should be taken over  $-(N-1)/2 \leq m \leq (N-1)/2$ .

<sup>6</sup>Notice that the FFT returns the negative  $\omega$  Fourier coefficients as the last half of the array,  $m = N/2 + 1, N/2 + 2, \dots$ . (This works because  $-N/2 + j$  and  $N/2 + j$  differ by  $N$ , the periodicity of the FFT.) One must be careful about this when using Fourier transforms to solve calculus problems numerically. For example, to evolve a density  $\rho(x)$  under the diffusion equation (Section 2.4.1) one must multiply the first half of the array  $\tilde{\rho}_m$  by  $\exp(-Dk_m^2 t) = \exp(-D[m(2\pi/L)]^2 t)$  but multiply the second half by  $\exp(-D(K - k_m)^2 t) = \exp(-D[(N - m)(2\pi/L)]^2 t)$ .

<sup>7</sup>This allows one to write slightly faster FFTs specialized for real functions. One pays for the higher speed by an extra programming step unpacking the resulting Fourier spectrum.

<sup>8</sup>There is one more logical possibility: a discrete set of points that fill all space; the atomic displacements in an infinite crystal is the classic example. In Fourier space, such a system has continuous  $k$ , but periodic boundary conditions at  $\pm K/2 = \pm\pi/a$  (the edges of the Brillouin zone).

<sup>9</sup>The real world is invariant under the transformation  $i \leftrightarrow -i$ , but complex quantities will get conjugated. Swapping  $i$  for  $-i$  in the time series formulæ, for example, would make  $\chi''(\omega) = -\text{Im}[\chi(\omega)]$  in eqn 10.31 and would make  $\chi$  analytic in the lower half-plane in Fig. 10.12.

- More substantively, some use the complex conjugate of our formulæ, substituting  $-i$  for  $i$  in the time or space transform formulæ. This alternative convention makes no change for any real quantity.<sup>9</sup>
- Some use a  $1/\sqrt{T}$  and  $1/\sqrt{2\pi}$  factor symmetrically on the Fourier and inverse Fourier operations.
- Some use frequency and wavelength ( $f = 2\pi\omega$  and  $\lambda = 2\pi/k$ ) instead of angular frequency  $\omega$  and wavevector  $k$ . This makes the transform and inverse transform more symmetric, and avoids some of the prefactors.

Our Fourier conventions are those most commonly used in physics.

## A.2 Derivatives, convolutions, and correlations

The important differential and integral operations become multiplications in Fourier space. A calculus problem in  $t$  or  $x$  thus becomes an algebra exercise in  $\omega$  or  $k$ .

**Integrals and derivatives.** Because  $(d/dt)e^{-i\omega t} = -i\omega e^{i\omega t}$ , the Fourier coefficient of the derivative of a function  $y(t)$  is  $-i\omega$  times the Fourier coefficient of the function:

$$dy/dt = \sum \tilde{y}_m (-i\omega_m \exp(-i\omega_m t)) = \sum (-i\omega_m \tilde{y}_m) \exp(-i\omega_m t), \tag{A.15}$$

so

$$\left. \frac{d\tilde{y}}{dt} \right|_{\omega} = -i\omega \tilde{y}_{\omega}. \tag{A.16}$$

This holds also for the Fourier transform and the fast Fourier transform. Since the derivative of the integral gives back the original function, the Fourier series for the indefinite integral of a function  $y$  is thus given by dividing by  $-i\omega$ :

$$\int \widetilde{y(t)} dt = \frac{\tilde{y}_{\omega}}{-i\omega} = i \frac{\tilde{y}_{\omega}}{\omega} \tag{A.17}$$

<sup>10</sup>Either the mean  $\tilde{y}(\omega = 0)$  is zero or it is non-zero. If the mean of the function is zero, then  $\tilde{y}(\omega)/\omega = 0/0$  is undefined at  $\omega = 0$ . This makes sense; the indefinite integral has an arbitrary integration constant, which gives its Fourier series an arbitrary value at  $\omega = 0$ . If the mean of the function  $\bar{y}$  is not zero, then the integral of the function will have a term  $\bar{y}(t - t_0)$ . Hence the integral is not periodic and has no Fourier series. (On the infinite interval the integral has no Fourier transform because it is not in  $\mathbb{L}^2$ .)

except at  $\omega = 0$ .<sup>10</sup>

These relations are invaluable in the solution of many linear partial differential equations. For example, we saw in Section 2.4.1 that the diffusion equation

$$\frac{\partial \rho}{\partial t} = D \frac{\partial^2 \rho}{\partial x^2} \tag{A.18}$$

becomes manageable when we Fourier transform  $x$  to  $k$ :

$$\frac{\partial \tilde{\rho}_k}{\partial t} = -Dk^2 \tilde{\rho}, \tag{A.19}$$

$$\tilde{\rho}_k(t) = \rho_k(0) \exp(-Dk^2 t). \tag{A.20}$$

**Correlation functions and convolutions.** The absolute square of the Fourier transform<sup>11</sup>  $|\tilde{y}(\omega)|^2$  is given by the Fourier transform of the

<sup>11</sup>The absolute square of the Fourier transform of a time signal is called the *power spectrum*.

correlation function  $C(\tau) = \langle y(t)y(t + \tau) \rangle$ :

$$\begin{aligned} |\tilde{y}(\omega)|^2 &= \tilde{y}(\omega)^* \tilde{y}(\omega) = \int dt' e^{-i\omega t'} y(t') \int dt e^{i\omega t} y(t) \\ &= \int dt dt' e^{i\omega(t-t')} y(t') y(t) = \int d\tau e^{i\omega\tau} \int dt' y(t') y(t' + \tau) \\ &= \int d\tau e^{i\omega\tau} T \langle y(t)y(t + \tau) \rangle = T \int d\tau e^{i\omega\tau} C(\tau) \\ &= T \tilde{C}(\omega), \end{aligned} \tag{A.21}$$

where  $T$  is the total time  $t$  during which the Fourier spectrum is being measured. Thus diffraction experiments, by measuring the square of the  $\mathbf{k}$ -space Fourier transform, give us the spatial correlation function for the system (Section 10.2).

The convolution<sup>12</sup>  $h(z)$  of two functions  $f(x)$  and  $g(y)$  is defined as

$$h(z) = \int f(x)g(z - x) dx. \tag{A.22}$$

The Fourier transform of the convolution is the product of the Fourier transforms. In three dimensions,<sup>13</sup>

$$\begin{aligned} \tilde{f}(\mathbf{k})\tilde{g}(\mathbf{k}) &= \int e^{-i\mathbf{k}\cdot\mathbf{x}} f(\mathbf{x}) d\mathbf{x} \int e^{-i\mathbf{k}\cdot\mathbf{y}} g(\mathbf{y}) d\mathbf{y} \\ &= \int e^{-i\mathbf{k}\cdot(\mathbf{x}+\mathbf{y})} f(\mathbf{x})g(\mathbf{y}) d\mathbf{x} d\mathbf{y} = \int e^{-i\mathbf{k}\cdot\mathbf{z}} d\mathbf{z} \int f(\mathbf{x})g(\mathbf{z} - \mathbf{x}) d\mathbf{x} \\ &= \int e^{-i\mathbf{k}\cdot\mathbf{z}} h(\mathbf{z}) d\mathbf{z} = \tilde{h}(\mathbf{k}). \end{aligned} \tag{A.23}$$

<sup>12</sup>Convolutions show up in sums and Green's functions. The sum  $\mathbf{z} = \mathbf{x} + \mathbf{y}$  of two random vector quantities with probability distributions  $f(\mathbf{x})$  and  $g(\mathbf{y})$  has a probability distribution given by the convolution of  $f$  and  $g$  (Exercise 1.2). An initial condition  $f(\mathbf{x}, t_0)$  propagated in time to  $t_0 + \tau$  is given by convolving with a Green's function  $g(\mathbf{y}, \tau)$  (Section 2.4.2).

<sup>13</sup>The convolution and correlation theorems are closely related; we do convolutions in time and correlations in space to illustrate both the one-dimensional and vector versions of the calculation.

### A.3 Fourier methods and function space

There is a nice analogy between the space of vectors  $\mathbf{r}$  in three dimensions and the space of functions  $y(t)$  periodic with period  $T$ , which provides a simple way of thinking about Fourier series. It is natural to define our function space to including all complex functions  $y(t)$ . (After all, we want the complex Fourier plane-waves  $e^{-i\omega_m t}$  to be in our space.) Let us list the following common features of these two spaces.

- **Vector space.** A vector  $\mathbf{r} = (r_1, r_2, r_3)$  in  $\mathbb{R}^3$  can be thought of as a real-valued function on the set  $\{1, 2, 3\}$ . Conversely, the function  $y(t)$  can be thought of as a vector with one complex component for each  $t \in [0, T)$ .

Mathematically, this is an evil analogy. Most functions which have independent random values for each point  $t$  are undefinable, unintegrable, and generally pathological. The space becomes well defined if we confine ourselves to functions  $y(t)$  whose absolute squares  $|y(t)|^2 = y(t)y^*(t)$  can be integrated. This vector space of functions is called  $\mathbb{L}^2$ .<sup>14</sup>

<sup>14</sup>More specifically, the Fourier transform is usually defined on  $\mathbb{L}^2[\mathbb{R}]$ , and the Fourier series is defined on  $\mathbb{L}^2[0, T]$ .

- **Inner product.** The analogy to the dot product of two three-dimensional vectors  $\mathbf{r} \cdot \mathbf{s} = r_1s_1 + r_2s_2 + r_3s_3$  is an inner product between two functions  $y$  and  $z$ :

$$y \cdot z = \frac{1}{T} \int_0^T y(t)z^*(t) dt. \tag{A.24}$$

You can think of this inner product as adding up all the products  $y_t z_t^*$  over all points  $t$ , except that we weight each point by  $dt/T$ .

- **Norm.** The distance between two three-dimensional vectors  $\mathbf{r}$  and  $\mathbf{s}$  is given by the *norm* of the difference  $|\mathbf{r} - \mathbf{s}|$ . The norm of a vector is the square root of the dot product of the vector with itself, so  $|\mathbf{r} - \mathbf{s}| = \sqrt{(\mathbf{r} - \mathbf{s}) \cdot (\mathbf{r} - \mathbf{s})}$ . To make this inner product norm work in function space, we need to know that the inner product of a function with itself is never negative. This is why, in our definition A.24, we took the complex conjugate of  $z(t)$ . This norm on function space is called the  $L^2$  norm:

$$\|y\|_2 = \sqrt{\frac{1}{T} \int_0^T |y(t)|^2 dt}. \tag{A.25}$$

Thus our restriction to square-integrable functions makes the norm of all functions in our space finite.<sup>15</sup>

- **Basis.** A natural basis for  $\mathbb{R}^3$  is given by the three unit vectors  $\hat{\mathbf{x}}_1, \hat{\mathbf{x}}_2, \hat{\mathbf{x}}_3$ . A natural basis for our space of functions is given by the functions  $\hat{f}_m = e^{-i\omega_m t}$ , with  $\omega_m = 2\pi m/T$  to keep them periodic with period  $T$ .
- **Orthonormality.** The basis in  $\mathbb{R}^3$  is orthonormal, with  $\hat{\mathbf{x}}_i \cdot \hat{\mathbf{x}}_j$  equaling one if  $i = j$  and zero otherwise. Is this also true of the vectors in our basis of plane waves? They are normalized:

$$\|\hat{f}_m\|_2^2 = \frac{1}{T} \int_0^T |e^{-i\omega_m t}|^2 dt = 1. \tag{A.26}$$

They are also orthogonal, with

$$\begin{aligned} \hat{f}_m \cdot \hat{f}_n &= \frac{1}{T} \int_0^T e^{-i\omega_m t} e^{i\omega_n t} dt = \frac{1}{T} \int_0^T e^{-i(\omega_m - \omega_n)t} dt \\ &= \frac{1}{-i(\omega_m - \omega_n)T} e^{-i(\omega_m - \omega_n)t} \Big|_0^T = 0 \end{aligned} \tag{A.27}$$

(unless  $m = n$ ) since  $e^{-i(\omega_m - \omega_n)T} = e^{-i2\pi(m-n)} = 1 = e^{-i0}$ .

- **Coefficients.** The coefficients of a three-dimensional vector are given by taking dot products with the basis vectors:  $r_n = \mathbf{r} \cdot \hat{\mathbf{x}}_n$ . The analogy in function space gives us the definition of the Fourier coefficients, eqn A.1:

$$\tilde{y}_m = y \cdot \hat{f}_m = \frac{1}{T} \int_0^T y(t) \exp(i\omega_m t) dt. \tag{A.28}$$

- **Completeness.** We can write an arbitrary three-dimensional vector  $\mathbf{r}$  by summing the basis vectors weighted by the coefficients:  $\mathbf{r} =$

<sup>15</sup>Another important property is that the only vector whose norm is zero is the zero vector. There are many functions whose absolute squares have integral zero, like the function which is zero except at  $T/2$ , where it is one, and the function which is zero on irrationals and one on rationals. Mathematicians finesse this difficulty by defining the vectors in  $L^2$  not to be functions, but rather to be *equivalence classes* of functions whose relative distance is zero. Hence the zero vector in  $L^2$  includes all functions with norm zero.

$\sum r_n \hat{x}_n$ . The analogy in function space gives us the formula A.2 for the inverse Fourier series:

$$y = \sum_{m=-\infty}^{\infty} \tilde{y}_m \hat{f}_m, \tag{A.29}$$

$$y(t) = \sum_{m=-\infty}^{\infty} \tilde{y}_m \exp(-i\omega_m t).$$

One can show that any function in  $L^2$  can be expanded in our basis  $\hat{f}_m$ ; eqn A.29 converges.

Our coefficient eqn A.28 follows from our completeness eqn A.29 and orthonormality:

$$\begin{aligned} \tilde{y}_\ell &\stackrel{?}{=} y \cdot \hat{f}_\ell = \left( \sum_m \tilde{y}_m \hat{f}_m \right) \cdot \hat{f}_\ell \\ &= \sum_m \tilde{y}_m \left( \hat{f}_m \cdot \hat{f}_\ell \right) = \tilde{y}_\ell \end{aligned} \tag{A.30}$$

or, writing things out,

$$\begin{aligned} \tilde{y}_\ell &\stackrel{?}{=} \frac{1}{T} \int_0^T y(t) e^{i\omega_\ell t} dt \\ &= \frac{1}{T} \int_0^T \left( \sum_m \tilde{y}_m e^{-i\omega_m t} \right) e^{i\omega_\ell t} dt \\ &= \sum_m \tilde{y}_m \left( \frac{1}{T} \int_0^T e^{-i\omega_m t} e^{i\omega_\ell t} dt \right) = \tilde{y}_\ell. \end{aligned} \tag{A.31}$$

Our function space, together with our inner product (eqn A.24), is a *Hilbert space* (a complete inner product space).

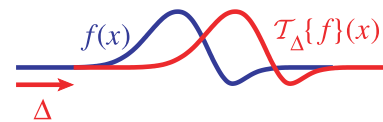
### A.4 Fourier and translational symmetry

Why are Fourier methods so useful? In particular, why are the solutions to linear differential equations so often given by plane waves: sines and cosines and  $e^{ikx}$ ?<sup>16</sup> Most of our basic equations are derived for systems with a *translational symmetry*. Time-translational invariance holds for any system without an explicit external time-dependent force; invariance under spatial translations holds for all homogeneous systems.

Why are plane waves special for systems with translational invariance? *Plane waves are the eigenfunctions of the translation operator.* Define  $\mathcal{T}_\Delta$ , an operator which takes function space into itself, and acts to shift the function a distance  $\Delta$  to the right:<sup>17</sup>

$$\mathcal{T}_\Delta\{f\}(x) = f(x - \Delta). \tag{A.32}$$

Any solution  $f(x, t)$  to a translation-invariant equation will be mapped by  $\mathcal{T}_\Delta$  onto another solution. Moreover,  $\mathcal{T}_\Delta$  is a linear operator (translating the sum is the sum of the translated functions). If we think of the



**Fig. A.2** The mapping  $\mathcal{T}_\Delta$  takes function space into function space, shifting the function to the right by a distance  $\Delta$ . For a physical system that is translation invariant, a solution translated to the right is still a solution.

<sup>16</sup>It is true, we are making a big deal about what is usually called the separation of variables method. But why does separation of variables so often work, and why do the separated variables so often form sinusoids and exponentials?

<sup>17</sup>That is, if  $g = \mathcal{T}_\Delta\{f\}$ , then  $g(x) = f(x - \Delta)$ , so  $g$  is  $f$  shifted to the right by  $\Delta$ .

<sup>18</sup>You are familiar with eigenvectors of  $3 \times 3$  symmetric matrices  $M$ , which transform into multiples of themselves when multiplied by  $M$ ,  $M \cdot \mathbf{e}_n = \lambda_n \mathbf{e}_n$ . The translation  $\mathcal{T}_\Delta$  is a linear operator on function space just as  $M$  is a linear operator on  $\mathbb{R}^3$ .

<sup>19</sup>The real exponential  $e^{Ax}$  is also an eigenstate, with eigenvalue  $e^{-A\Delta}$ . This is also allowed. Indeed, the diffusion equation is time-translation invariant, and it has solutions which decay exponentially in time ( $e^{-\omega_k t} e^{ikx}$ , with  $\omega_k = Dk^2$ ). Exponentially decaying solutions in space also arise in some translation-invariant problems, such as quantum tunneling and the penetration of electromagnetic radiation into metals.

<sup>20</sup>Written out in equations, this simple idea is even more obscure. Let  $\mathcal{U}_t$  be the time-evolution operator for a translationally-invariant equation (like the diffusion equation of Section 2.2). That is,  $\mathcal{U}_t\{\rho\}$  evolves the function  $\rho(x, \tau)$  into  $\rho(x, \tau + t)$ . ( $\mathcal{U}_t$  is not translation in time, but evolution in time.) Because our system is translation invariant, translated solutions are also solutions for translated initial conditions:  $\mathcal{T}_\Delta\{\mathcal{U}_t\{\rho\}\} = \mathcal{U}_t\{\mathcal{T}_\Delta\{\rho\}\}$ . Now, if  $\rho_k(x, 0)$  is an eigenstate of  $\mathcal{T}_\Delta$  with eigenvalue  $\lambda_k$ , is  $\rho_k(x, t) = \mathcal{U}_t\{\rho_k\}(x)$  an eigenstate with the same eigenvalue? Yes indeed:

$$\begin{aligned} \mathcal{T}_\Delta\{\rho_k(x, t)\} &= \mathcal{T}_\Delta\{\mathcal{U}_t\{\rho_k(x, 0)\}\} \\ &= \mathcal{U}_t\{\mathcal{T}_\Delta\{\rho_k(x, 0)\}\} \\ &= \mathcal{U}_t\{\lambda_k \rho_k(x, 0)\} \\ &= \lambda_k \mathcal{U}_t\{\rho_k(x, 0)\} \\ &= \lambda_k \rho_k(x, t) \end{aligned} \tag{A.34}$$

because the evolution law  $\mathcal{U}_t$  is linear.

translation operator as a big matrix acting on function space, we can ask for its eigenvalues<sup>18</sup> and eigenvectors (or *eigenfunctions*)  $f_k$ :

$$\mathcal{T}_\Delta\{f_k\}(x) = f_k(x - \Delta) = \lambda_k f_k(x). \tag{A.33}$$

This equation is solved by our complex plane waves  $f_k(x) = e^{ikx}$ , with  $\lambda_k = e^{-ik\Delta}$ .<sup>19</sup>

Why are these eigenfunctions useful? The time evolution of an eigenfunction must have the same eigenvalue  $\lambda$ ! The argument is something of a tongue-twister: translating the time-evolved eigenfunction gives the same answer as time evolving the translated eigenfunction, which is time evolving  $\lambda$  times the eigenfunction, which is  $\lambda$  times the time-evolved eigenfunction.<sup>20</sup>

The fact that the different eigenvalues do not mix under time evolution is precisely what made our calculation work; time evolving  $A_0 e^{ikx}$  had to give a multiple  $A(t) e^{ikx}$  since there is only one eigenfunction of translations with the given eigenvalue. Once we have reduced the partial differential equation to an ordinary differential equation for a few eigenstate amplitudes, the calculation becomes feasible.

Quantum physicists will recognize the tongue-twister above as a statement about simultaneously diagonalizing commuting operators: since translations commute with time evolution, one can find a complete set of translation eigenstates which are also time-evolution solutions. Mathematicians will recognize it from group representation theory: the solutions to a translation-invariant linear differential equation form a representation of the translation group, and hence they can be decomposed into irreducible representations of that group. These approaches are basically equivalent, and very powerful. One can also use these approaches for systems with other symmetries. For example, just as the invariance of homogeneous systems under translations leads to plane-wave solutions with definite wavevector  $k$ , it is true that:

- the invariance of isotropic systems (like the hydrogen atom) under the rotation group leads naturally to solutions involving spherical harmonics with definite angular momenta  $\ell$  and  $m$ ;
- the invariance of the strong interaction under SU(3) leads naturally to the ‘8-fold way’ families of mesons and baryons; and
- the invariance of the Universe under the Poincaré group of space-time symmetries (translations, rotations, and Lorentz boosts) leads naturally to particles with definite mass and spin!

## Exercises

We begin with three Fourier series exercises, *Sound wave*, *Fourier cosines* (numerical), and *Double sinusoids*. We then explore Fourier transforms with *Fourier Gaussians* (numerical) and *Uncertainty*, focusing on the effects of translating and scaling the width of the function to be transformed. *Fourier relationships* analyzes the normalization needed to go from the FFT to the Fourier series, and *Aliasing and windowing* explores two common numerical inaccuracies associated with the FFT. *White noise* explores the behavior of Fourier methods on random functions. *Fourier matching* is a quick, visual test of one's understanding of Fourier methods. Finally, *Gibbs phenomenon* explores what happens when you torture a Fourier series by insisting that smooth sinusoids add up to a function with a jump discontinuity.

### (A.1) Sound wave. ①

A musical instrument playing a note of frequency  $\omega_1$  generates a pressure wave  $P(t)$  periodic with period  $2\pi/\omega_1$ :  $P(t) = P(t + 2\pi/\omega_1)$ . The complex Fourier series of this wave (eqn A.2) is zero except for  $m = \pm 1$  and  $\pm 2$ , corresponding to the fundamental  $\omega_1$  and the first overtone. At  $m = 1$ , the Fourier amplitude is  $2 - i$ , at  $m = -1$  it is  $2 + i$ , and at  $m = \pm 2$  it is 3. What is the pressure  $P(t)$ :

- (A)  $\exp((2 + i)\omega_1 t) + 2 \exp(3\omega_1 t)$ ,
- (B)  $\exp(2\omega_1 t) \exp(i\omega_1 t) \times 2 \exp(3\omega_1 t)$ ,
- (C)  $\cos 2\omega_1 t - \sin \omega_1 t + 2 \cos 3\omega_1 t$ ,
- (D)  $4 \cos \omega_1 t - 2 \sin \omega_1 t + 6 \cos 2\omega_1 t$ ,
- (E)  $4 \cos \omega_1 t + 2 \sin \omega_1 t + 6 \cos 2\omega_1 t$ ?

### (A.2) Fourier cosines. (Computation) ②

In this exercise, we will use the computer to illustrate features of Fourier series and discrete fast Fourier transforms using sinusoidal waves. Download the Fourier software, or the relevant hints files, from the computer exercises section of the book web site [129].<sup>21</sup>

First, we will take the Fourier series of periodic functions  $y(x) = y(x + L)$  with  $L = 20$ . We will sample the function at  $N = 32$  points, and use a FFT to approximate the Fourier series. The Fourier series will be plotted as functions

of  $k$ , at  $-k_{N/2}, \dots, k_{N/2-2}, k_{N/2-1}$ . (Remember that the negative  $m$  points are given by the last half of the FFT.)

(a) Analytically (that is, with paper and pencil) derive the Fourier series  $\tilde{y}_m$  in this interval for  $\cos(k_1 x)$  and  $\sin(k_1 x)$ . Hint: They are zero except at the two values  $m = \pm 1$ . Use the spatial transform (eqn A.3).

(b) What spacing  $\delta k$  between  $k$ -points  $k_m$  do you expect to find? What is  $k_{N/2}$ ? Evaluate each analytically as a function of  $L$  and numerically for  $L = 20$ .

Numerically (on the computer) choose a cosine wave  $A \cos(k(x - x_0))$ , evaluated at 32 points from  $x = 0$  to 20 as described above, with  $k = k_1 = 2\pi/L$ ,  $A = 1$ , and  $x_0 = 0$ . Examine its Fourier series.

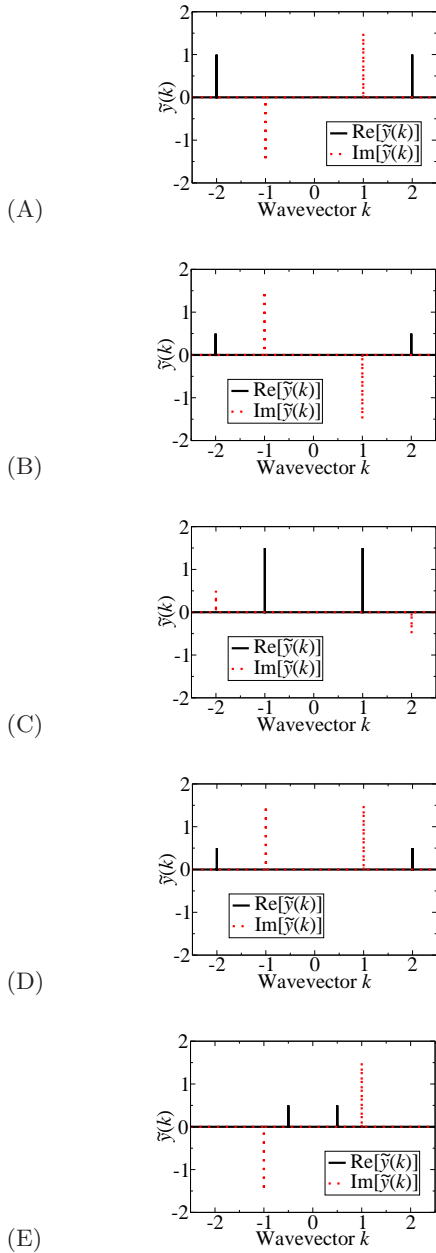
(c) Check your predictions from part (a) for the Fourier series for  $\cos(k_1 x)$  and  $\sin(k_1 x)$ . Check your predictions from part (b) for  $\delta k$  and for  $k_{N/2}$ .

Decrease  $k$  to increase the number of wavelengths, keeping the number of data points fixed. Notice that the Fourier series looks fine, but that the real-space curves quickly begin to vary in amplitude, much like the patterns formed by beating (superimposing two waves of different frequencies). By increasing the number of data points, you can see that the beating effect is due to the small number of points we sample. Even for large numbers of sampled points  $N$ , though, beating will still happen at very small wavelengths (when we get close to  $k_{N/2}$ ). Try various numbers of waves  $m$  up to and past  $m = N/2$ .

### (A.3) Double sinusoid. ②

Which picture represents the spatial Fourier series (eqn A.4) associated with the function  $f(x) = 3 \sin(x) + \cos(2x)$ ? (The solid line is the real part, the dashed line is the imaginary part.)

<sup>21</sup>If this exercise is part of a computer lab, one could assign the analytical portions as a pre-lab exercise.



(A.4) **Fourier Gaussians.** (Computation) ②

In this exercise, we will use the computer to illustrate features of Fourier transforms, focusing on the particular case of Gaussian functions, but illustrating general properties. Download the Fourier software or the relevant hints files from the computer exercises portion of the text web site [129].<sup>22</sup>

The Gaussian distribution (also known as the normal distribution) has the form

$$G(x) = \frac{1}{\sqrt{2\pi}\sigma} \exp\left(-\frac{(x-x_0)^2}{2\sigma^2}\right), \quad (\text{A.35})$$

where  $\sigma$  is the standard deviation and  $x_0$  is the center. Let

$$G_0(x) = \frac{1}{\sqrt{2\pi}} \exp(-x^2/2) \quad (\text{A.36})$$

be the Gaussian of mean zero and  $\sigma = 1$ . The Fourier transform of  $G_0$  is another Gaussian, of standard deviation one, but no normalization factor.<sup>23</sup>

$$\tilde{G}_0(k) = \exp(-k^2/2). \quad (\text{A.38})$$

In this exercise, we study how the Fourier transform of  $G(x)$  varies as we change  $\sigma$  and  $x_0$ .

*Widths.* As we make the Gaussian narrower (smaller  $\sigma$ ), it becomes more pointy. Shorter lengths mean higher wavevectors, so we expect that its Fourier transform will get wider.

(a) Starting with the Gaussian with  $\sigma = 1$ , numerically measure the width of its Fourier transform at some convenient height. (The full width at half maximum, FWHM, is a sensible choice.) Change  $\sigma$  to 2 and to 0.1, and measure the widths, to verify that the Fourier space width goes inversely with the real width.

(b) Analytically show that this rule is true in general. Change variables in eqn A.6 to show that if  $z(x) = y(Ax)$  then  $\tilde{z}(k) = \tilde{y}(k/A)/A$ . Using eqn A.36 and this general rule, write a formula for the Fourier transform of a Gaussian centered at zero with arbitrary width  $\sigma$ .

(c) Analytically compute the product  $\Delta x \Delta k$  of the FWHM of the Gaussians in real and Fourier space. (Your answer should be independent of

<sup>22</sup>If this exercise is taught as a computer lab, one could assign the analytical portions as a pre-lab exercise.

<sup>23</sup>Here is an elementary-looking derivation. We complete the square inside the exponent, and change from  $x$  to  $y = x + ik$ :

$$\frac{1}{\sqrt{2\pi}} \int_{-\infty}^{\infty} e^{-ikx} \exp(-x^2/2) dx = \frac{1}{\sqrt{2\pi}} \int_{-\infty}^{\infty} \exp(-(x+ik)^2/2) dx \exp((ik)^2/2) = \left[ \int_{-\infty+ik}^{\infty+ik} \frac{1}{\sqrt{2\pi}} \exp(-y^2/2) dy \right] \exp(-k^2/2). \quad (\text{A.37})$$

The term in brackets is one (giving us  $e^{-k^2/2}$ ) but to show it we need to shift the integration contour from  $\text{Im}[y] = k$  to  $\text{Im}[y] = 0$ , which demands Cauchy's theorem (Fig. 10.11).



the width  $\sigma$ .) This is related to the Heisenberg uncertainty principle,  $\Delta x \Delta p \sim \hbar$ , which you learn about in quantum mechanics.

*Translations.* Notice that a narrow Gaussian centered at some large distance  $x_0$  is a reasonable approximation to a  $\delta$ -function. We thus expect that its Fourier transform will be similar to the plane wave  $\tilde{G}(k) \sim \exp(-ikx_0)$  we would get from  $\delta(x - x_0)$ .

(d) Numerically change the center of the Gaussian. How does the Fourier transform change? Convince yourself that it is being multiplied by the factor  $\exp(-ikx_0)$ . How does the power spectrum  $|\tilde{G}(\omega)|^2$  change as we change  $x_0$ ?

(e) Analytically show that this rule is also true in general. Change variables in eqn A.6 to show that if  $z(x) = y(x - x_0)$  then  $\tilde{z}(k) = \exp(-ikx_0)\tilde{y}(k)$ . Using this general rule, extend your answer from part (b) to write the formula for the Fourier transform of a Gaussian of width  $\sigma$  and center  $x_0$ .

(A.5) Uncertainty. ②

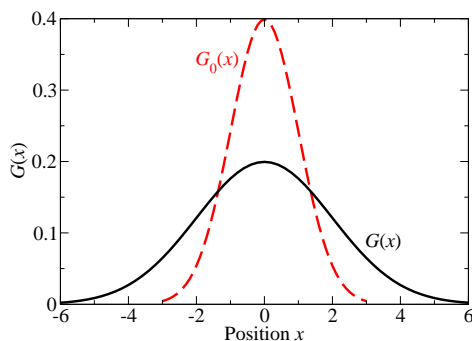
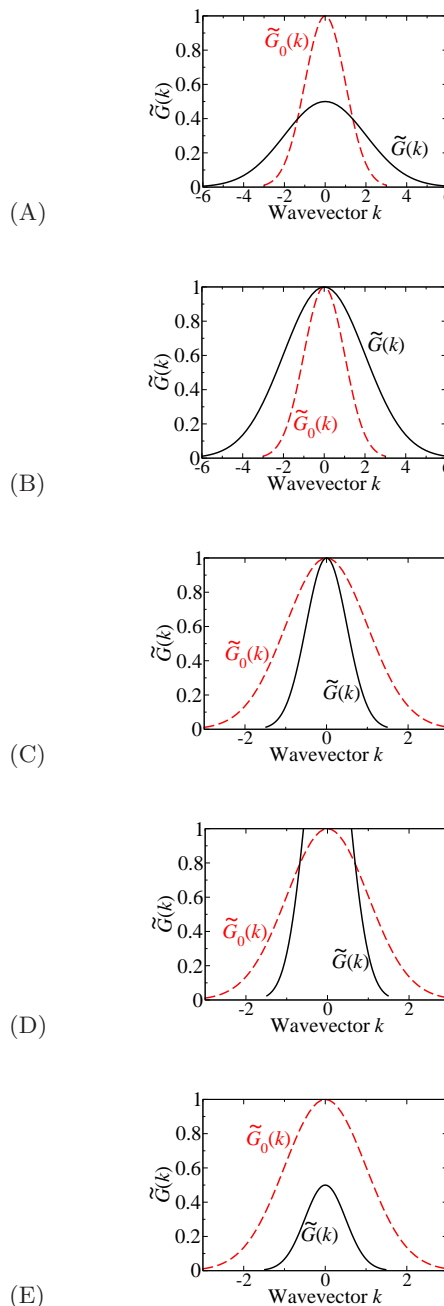


Fig. A.3 Real-space Gaussians.

The dashed line in Fig. A.3 shows

$$G_0(x) = 1/\sqrt{2\pi} \exp(-x^2/2). \quad (\text{A.39})$$

The dark line shows another function  $G(x)$ . The areas under the two curves  $G(x)$  and  $G_0(x)$  are the same. The dashed lines in the choices below represent the Fourier transform  $\tilde{G}_0(k) = \exp(-k^2/2)$ . Which has a solid curve that represents the Fourier transform of  $G$ ?



(A.6) Fourier relationships. ②

In this exercise, we explore the relationships between the Fourier series and the fast Fourier transform. The first is continuous and periodic

in real space, and discrete and unbounded in Fourier space; the second is discrete and periodic both in real and in Fourier space. Thus, we must again convert integrals into sums (as in Fig. A.1).

As we take the number of points  $N$  in our FFT to  $\infty$  the spacing between the points gets smaller and smaller, and the approximation of the integral as a sum gets better and better.

Let  $y_\ell = y(t_\ell)$  where  $t_\ell = \ell(T/N) = \ell(\Delta t)$ . Approximate the Fourier series integral A.1 above as a sum over  $y_\ell$ ,  $(1/T) \sum_{\ell=0}^{N-1} y(t_\ell) \exp(-i\omega_m t_\ell) \Delta t$ . For small positive  $m$ , give the constant relating  $\tilde{y}_m^{\text{FFT}}$  to the Fourier series coefficient  $\tilde{y}_m$ .

(A.7) **Aliasing and windowing.** (Computation) ③

In this exercise, we will use the computer to illustrate numerical challenges in using the fast Fourier transform. Download the Fourier software, or the relevant hints files, from the computer exercises section of the book web site [129].<sup>24</sup>

The Fourier series  $\tilde{y}_m$  runs over all integers  $m$ . The fast Fourier transform runs only over  $0 \leq m < N$ . There are three ways to understand this difference: function-space dimension, wavelengths, and aliasing.

*Function-space dimension.* The space of periodic functions  $y(t)$  on  $0 \leq t < T$  is infinite, but we are sampling them only at  $N$  points. The space of possible fast Fourier series must also have  $N$  dimensions. Now, each coefficient of the FFT is complex (two dimensions), but the negative frequencies are complex conjugate to their positive partners (giving two net dimensions for the two frequencies  $\omega_m$  and  $\omega_{-m} \equiv \omega_{N-m}$ ). If you are fussy,  $\tilde{y}_0$  has no partner, but is real (only one dimension), and if  $N$  is even  $\tilde{y}_{-N/2}$  also is partnerless, but is real. So  $N$   $k$ -points are generated by  $N$  real points.

*Wavelength.* The points at which we sample the function are spaced  $\Delta = T/N$  apart. It makes sense that the fast Fourier transform would stop when the wavelength becomes close to  $\Delta$ ; we cannot resolve wiggles shorter than our sample spacing.

(a) If the number of points  $N$  is even, show that the fast Fourier transform stops when the wavelength becomes twice  $\Delta$ . (Hint: Which  $m$  has

the shortest wavelength? Show that this wave alternates between  $\pm C$  in time.) Show that this component of  $\tilde{y}$  in Fourier space is partnerless. If  $y(t)$  is real, show that this component is real as well.

So, the FFT returns Fourier components only until  $\omega_{N/2}$  when there is one point per bump (half-period) in the cosine wave.

*Aliasing.* Suppose our function really does have wiggles with shorter distances than our sampling time  $\Delta$ . Then its fast Fourier transform will have contributions to the long-wavelength coefficients  $\tilde{y}_m^{\text{FFT}}$  from these shorter wavelength wiggles; specifically  $\tilde{y}_{m \pm N}$ ,  $\tilde{y}_{m \pm 2N}$ , etc.

(b) On our sampled points  $t_\ell$ , analytically show that  $\exp(i\omega_{m \pm N} t_\ell) = \exp(i\omega_m t_\ell)$ . Show that the FFT  $\tilde{y}_m$  can be written in terms of the Fourier series  $\tilde{y}_m$ , up to an overall constant factor, as

$$\tilde{y}_m^{\text{FFT}} \propto \sum_{n=-\infty}^{\infty} \tilde{y}_{m+nN}$$

(Hint: the ‘comb’ function  $\sum_{j=-\infty}^{\infty} \delta(t - j\Delta) = (1/\Delta) \sum_{n=-\infty}^{\infty} e^{2\pi i n t / \Delta}$ .) Which term is the desired answer? Thus show that the fast Fourier transform has bogus contributions from all frequencies outside its cutoff, folded in (or aliased into) the low frequency window.

If you sample a function at  $N$  points with Fourier components beyond  $\omega_{N/2}$ , their contributions get added to Fourier components at smaller frequencies. This is called *aliasing*, and is an important source of error in Fourier methods. We always strive to sample enough points to avoid it.

(c) Form a 32-point wave packet  $y(t) = 1/(\sqrt{2\pi}\sigma) \exp(-t^2/2\sigma^2)$ . Change the width  $\sigma$  of the packet to make it thinner, until the packet begins to look ratty (almost as thin as the spacing between the sample points  $t_\ell$ ). Plot the function and its FFT. Notice how the Fourier series aliases as it hits the edges and overlaps.

(d) Windowing. One often needs to take Fourier series of functions which are not periodic in the interval. Set the number of data points  $N$  to 256 (powers of two are faster) and plot  $y(t) = \cos \omega_m t$  for  $m = 20$  with an ‘illegal’ non-integer value  $m = 20.5$ . Note that the plot of the real-space function  $y(t)$  is not periodic in the interval  $[0, T)$  for  $m = 20.5$ . Plot its Fourier series. Note that each of the two peaks has broad-

<sup>24</sup>If this exercise is taught as a computer lab, one could assign the analytical portions as a pre-lab exercise.

ened into a whole staircase. Try looking at the power spectrum (which is proportional to  $|\tilde{y}|^2$ ), and again compare  $m = 20$  with  $m = 20.5$ . This is a numerical problem known as *windowing*, and there are various schemes to minimize its effects as well.

(A.8) **White noise.** (Computation) ②

White light is a mixture of light of all frequencies. White noise is a mixture of all sound frequencies, with constant average power per unit frequency. The hissing noise you hear on radio and TV between stations is approximately white noise; there are a lot more high frequencies than low ones, so it sounds high-pitched.

Download the Fourier software or the relevant hints files from the computer exercises portion of the text web site [129].

What kind of time signal would generate white noise? Select *White Noise*, or generate independent random numbers  $y_\ell = y(\ell L/N)$  chosen from a Gaussian<sup>25</sup> distribution  $\rho(y) = (1/\sqrt{2\pi}) \exp(-y^2/2\sigma)$ . You should see a jagged, random function. Set the number of data points to, say, 1024.

Examine the Fourier transform of the noise signal. The Fourier transform of the white noise looks amazingly similar to the original signal. It is different, however, in two important ways. First, it is complex: there is a real part and an imaginary part. The second is for you to discover.

Examine the region near  $k = 0$  on the Fourier plot, and describe how the Fourier transform of the noisy signal is different from a random function. In particular, what symmetry do the real and imaginary parts have? Can you show that this is true for any real function  $y(x)$ ?

Now examine the power spectrum  $|\tilde{y}|^2$ .<sup>26</sup> Check that the power is noisy, but on average is crudely independent of frequency. (You can check this best by varying the random number seed.) White noise is usually due to random, uncorrelated fluctuations in time.

(A.9) **Fourier matching.** ②

The top three plots (a)–(c) in Fig. A.4 are functions  $y(x)$  of position. For each, pick out which of the six plots (1)–(6) are the corresponding function  $\tilde{y}$  in Fourier space? (Dark line is real part, lighter dotted line is imaginary part.) (This exercise should be fairly straightforward after doing Exercises A.2, A.4, and A.8.)

(A.10) **Gibbs phenomenon.** (Mathematics) ③

In this exercise, we will look at the Fourier series for the step function and the triangle function. They are challenging because of the sharp corners, which are hard for sine waves to mimic.

Consider a function  $y(x)$  which is  $A$  in the range  $0 < x < L/2$  and  $-A$  in the range  $L/2 < x < L$  (shown above). It is a kind of step function, since it takes a step downward at  $L/2$  (Fig. A.5).<sup>27</sup>

(a) As a crude approximation, the step function looks a bit like a chunky version of a sine wave,  $A \sin(2\pi x/L)$ . In this crude approximation, what would the complex Fourier series be (eqn A.4)?

(b) Show that the odd coefficients for the complex Fourier series of the step function are  $\tilde{y}_m = -2\text{Ai}/(m\pi)$  ( $m$  odd). What are the even ones? Check that the coefficients  $\tilde{y}_m$  with  $m = \pm 1$  are close to those you guessed in part (a).

(c) Setting  $A = 2$  and  $L = 10$ , plot the partial sum of the Fourier series (eqn A.1) for  $m = -n, -n + 1, \dots, n$  with  $n = 1, 3,$  and  $5$ . (You are likely to need to combine the coefficients  $\tilde{y}_m$  and  $\tilde{y}_{-m}$  into sines or cosines, unless your plotting package knows about complex exponentials.) Does it converge to the step function? If it is not too inconvenient, plot the partial sum up to  $n = 100$ , and concentrate especially on the overshoot near the jumps in the function at  $0, L/2,$  and  $L$ . This overshoot is called the Gibbs phenomenon, and occurs when you try to approximate functions  $y(x)$  which have discontinuities.

One of the great features of Fourier series is that it makes taking derivatives and integrals easier. What does the integral of our step function look

<sup>25</sup>We choose the numbers with probability given by the Gaussian distribution, but it would look about the same if we took numbers with a uniform probability in, say, the range  $(-1, 1)$ .

<sup>26</sup>For a time signal  $f(t)$ , the average power at a certain frequency is proportional to  $|\tilde{f}(\omega)|^2$ ; ignoring the proportionality constant, the latter is often termed the power spectrum. This name is sometimes also used for the square of the amplitude of spatial Fourier transforms as well.

<sup>27</sup>It can be written in terms of the standard Heaviside step function  $\Theta(x) = 0$  for  $x < 0$  and  $\Theta(x) = 1$  for  $x > 0$ , as  $y(x) = A(1 - 2\Theta(x - L/2))$ .

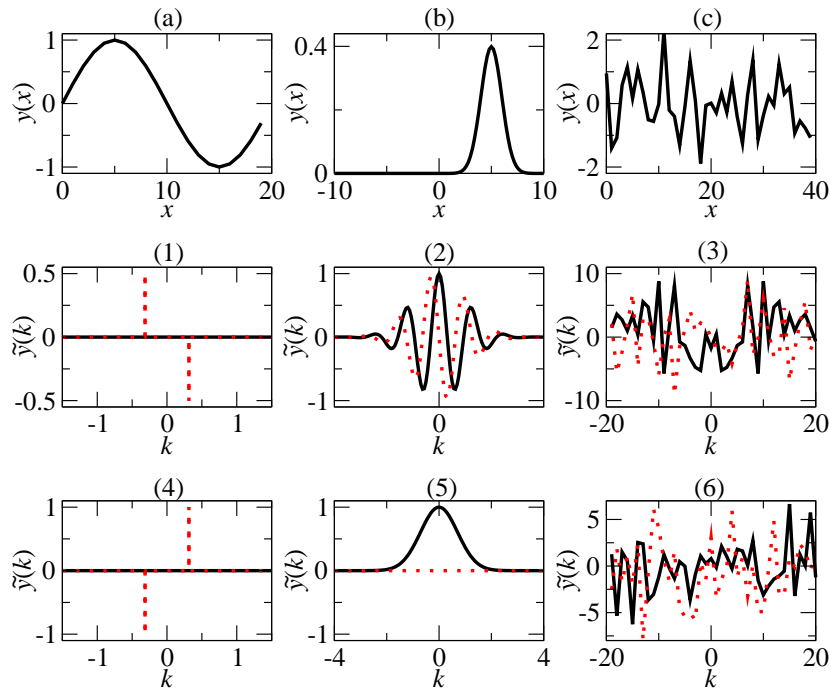


Fig. A.4 Fourier matching.

like? Let us sum the Fourier series for it!  
 (d) Calculate the Fourier series of the integral of the step function, using your complex Fourier series from part (b) and the formula A.17 for the Fourier series of the integral. Plot your results, doing partial sums up to  $\pm m = n$ , with  $n = 1, 3, \text{ and } 5$ , again with  $A = 2$  and  $L = 10$ . Would the derivative of this function look like the step function? If it is convenient, do  $n = 100$ , and notice there are no overshoots.

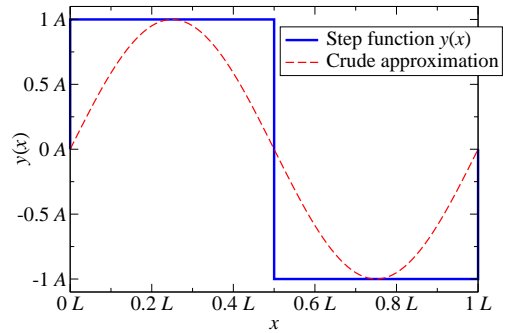


Fig. A.5 Step function.

# References

- [1] Ahlers, G. (1980). Critical phenomena at low temperatures. *Reviews of Modern Physics*, **52**, 489–503. [12.14](#)
- [2] Ambegaokar, V., Halperin, B. I., Nelson, D., and Siggia, E. (1978). Dissipation in two-dimensional superfluids. *Physical Review Letters*, **40**, 783–6. [22](#)
- [3] Ambegaokar, V., Halperin, B. I., Nelson, D., and Siggia, E. (1980). Dynamics of superfluid films. *Physical Review B*, **21**, 1806–26. [22](#)
- [4] Anderson, M. H., Ensher, J. R., Matthews, M. R., Wieman, C. E., and Cornell, E. A. (1995). Observation of Bose–Einstein condensation in a dilute atomic vapor. *Science*, **269**, 198. <http://jilawww.colorado.edu/bec/>. [7.14](#), [7.16](#)
- [5] Anderson, P. W. (1965). Coherent matter field phenomena in superfluids. In *Some recent definitions in the basic sciences*, Volume 2, pp. 21–40. Belfer Graduate School of Science, Yeshiva University, New York. Reprinted in [7, p. 229]. [9.8](#), [9.8](#)
- [6] Anderson, P. W. (1966). Considerations on the flow of superfluid helium. *Reviews of Modern Physics*, **38**, 298–310. Reprinted in [7, p. 249]. [9.8](#), [9.8](#)
- [7] Anderson, P. W. (1984). *Basic notions of condensed matter physics*. Benjamin–Cummings, Menlo Park, CA. [28](#), [5](#), [6](#)
- [8] Anderson, P. W. (1999). Solving problems in finite time. *Nature*, **400**, 115–6. [8.15](#)
- [9] Ashcroft, N. W. and Mermin, N. D. (1976). *Solid state physics*. Hold, Rinehart, and Wilson, Philadelphia. [23](#), [39](#), [7.12](#), [48](#), [6](#), [10.6](#)
- [10] Bailey, N. P., Creteigny, T., Sethna, J. P., Coffman, V. R., Dolgert, A. J., Myers, C. R., Schiøtz, J., and Mortensen, J. J. (2006). Digital material: a flexible atomistic simulation code. <http://arXiv.org/abs/cond-mat/0601236/>. [2.4](#), [3.4](#), [4.1](#), [6.1](#), [10.2](#)
- [11] Ben-Jacob, E., Goldenfeld, N., Langer, J. S., and Schön, Gerd (1983). Dynamics of interfacial pattern formation. *Physical Review Letters*, **51**, 1930–2. [11.9](#)
- [12] Ben-Jacob, E., Goldenfeld, N., Langer, J. S., and Schön, Gerd (1984). Boundary-layer model of pattern formation in solidification. *Physical Review A*, **29**, 330–40. [11.9](#)
- [13] Bender, C. M. and Orszag, S. A. (1978). *Advanced mathematical methods for scientists and engineers*. McGraw-Hill, New York. [1.5](#), [1.5](#)
- [14] Bennett, C. H. (1976). Efficient estimation of free energy differences from Monte Carlo data. *Journal of Computational*

- Physics*, **22**, 245–68. [6.8](#)
- [15] Bennett, C. H. (1982). The thermodynamics of computation—a review. *International Journal of Theoretical Physics*, **21**, 905–40. [5.2](#), [5.2](#), [5.3](#)
- [16] Berg, H. (2000). Motile behavior of bacteria. *Physics Today*, **53**, 24–9. <http://www.aip.org/pt/jan00/berg.htm>. [2.5](#)
- [17] Bhanot, G., Creutz, M., Horvath, I., Lacki, J., and Weckel, J. (1994). Series expansions without diagrams. *Physical Review E*, **49**, 2445–53. [25](#)
- [18] Bodenschatz, E., Utter, B., and Ragnarsson, R. (2002). Directional solidification of solvent/polymer alloys. <http://www.milou.ccmr.cornell.edu/solidification.html>. [11.12](#)
- [19] Bortz, A. B., Kalos, M. H., and Lebowitz, J. L. (1975). A new algorithm for Monte Carlo simulation of Ising spin systems. *Journal of Computational Physics*, **17**, 10–8. [36](#)
- [20] Brower, R. C., Kessler, D. A., Koplik, J., and Levine, Herbert (1983). Geometrical approach to moving interface dynamics. *Physical Review Letters*, **51**, 1111–4. [11.9](#)
- [21] Buchel, A. and Sethna, J. P. (1996). Elastic theory has zero radius of convergence. *Physical Review Letters*, **77**, 1520. [1.5](#), [9](#)
- [22] Buchel, A. and Sethna, J. P. (1997). Statistical mechanics of cracks: Thermodynamic limit, fluctuations, breakdown, and asymptotics of elastic theory. *Physical Review E*, **55**, 7669. [1.5](#)
- [23] Carathéodory, C. (1909). Untersuchungen über die Grundlagen der Thermodynamik. *Mathematische Annalen*, **67**, 355–86. [21](#)
- [24] Carathéodory, C. (1976). Untersuchungen über die Grundlagen der Thermodynamik (English translation). In *The second law of thermodynamics*, by J. Kestin, pp. 229–56. Dowden, Hutchinson and Ross, Inc., Stroudsburg, Pennsylvania. [21](#)
- [25] Cardy, J. (1996). *Scaling and renormalization in statistical physics*. Cambridge University Press. [44](#)
- [26] Carlson, J. M. and Langer, J. S. (1989). Properties of earthquakes generated by fault dynamics. *Physical Review Letters*, **62**, 2632. [12.4](#)
- [27] Chandler, D. (1987). *Introduction to modern statistical mechanics*. Oxford University Press. [1](#), [10.7](#)
- [28] Chayes, J. T., Chayes, L., Sethna, J. P., and Thouless, D. J. (1986). A mean-field spin glass with short-range interactions. *Communications in Mathematical Physics*, **106**, 41. [12.10](#), [12.11](#)
- [29] Choy, T.-S., Naset, J., Chen, J., Hershfield, S., and Stanton, C. (2000). The Fermi surface database. <http://www.phys.ufl.edu/fermisurface/>. [7.10](#), [7.11](#)
- [30] Chu, C. (1993). *Hysteresis and microstructures: a study of biaxial loading on compound twins of copper–aluminum–nickel single crystals*. Ph. D. thesis, Aerospace Engineering, University of Minnesota. [11.11](#)
- [31] Coleman, S. (1985). Secret symmetry: an introduction to spontaneous symmetry breakdown and gauge fields. In *Aspects of sym-*

- metry, selected Erice lectures*, pp. 113–84. Cambridge University Press. [9.1](#)
- [32] Curcic, T. and Cooper, B. H. (1995). STM images of nanoscale pit decay. [http://www.lassp.cornell.edu/cooper\\_nanoscale/nanofeatures.html](http://www.lassp.cornell.edu/cooper_nanoscale/nanofeatures.html). [10.2](#)
- [33] deGennes, P. G. and Prost, J. (1993). *The physics of liquid crystals*, 2nd edition. Clarendon Press, Oxford. [9.1](#)
- [34] Domb, C. (1974). Ising model. In *Phase transitions and critical phenomena*, Vol. 3, pp. 357–478. Academic Press, New York. [26](#)
- [35] Domb, C. and Guttman, A. J. (1970). Low-temperature series for the Ising model. *Journal of Physics C*, **8**, 1652–60. [25](#)
- [36] Dyson, F. J. (1979). Time without end: Physics and biology in an open universe. *Reviews of Modern Physics*, **51**, 447. [5.1](#)
- [37] Elowitz, M. B. and Leibler, S. (2000). A synthetic oscillatory network of transcriptional regulators. *Nature*, **403**, 335–8. [39](#), [8.11](#), [8.11](#), [8.11](#)
- [38] Fermi, E., Pasta, J., and Ulam, S. (1965). Studies of nonlinear problems. I. In *E. Fermi, collected papers*, Vol. II, pp. 978. University of Chicago Press, Chicago. (Reprinted from Los Alamos report LA-1940, 1955.). [20](#)
- [39] Feynman, R. P. (1972). *Statistical mechanics, a set of lectures*. Addison-Wesley, Menlo Park, CA. [42](#)
- [40] Feynman, R. P. (1996). *Feynman lectures on computation*. Westview, Boulder, CO. [5.2](#), [5.3](#), [5.3](#)
- [41] Feynman, R. P., Leighton, R. B., and Sands, M. (1963). *The Feynman lectures on physics*. Addison-Wesley, Menlo Park, CA. [2.3](#), [6.1](#), [7.8](#)
- [42] Fixsen, D. J., Cheng, E. S., Gales, J. M., Mather, J. C., Shafer, R. A., and Wright, E. L. (1996). The cosmic microwave background spectrum from the full COBE FIRAS data set. *The Astrophysical Journal*, **473**, 576–87. [7.17](#)
- [43] Forster, D. (1975). *Hydrodynamic fluctuations, broken symmetry, and correlation functions*. Benjamin-Cummings, Reading, MA. [1](#), [10.8](#), [26](#)
- [44] Frenkel, D. and Louis, A. A. (1992). Phase separation in a binary hard-core mixture. An exact result. *Physical Review Letters*, **68**, 3363. [6.13](#)
- [45] Gillespie, D. T. (1976). Exact simulation of coupled chemical reactions. *Journal of Computational Physics*, **22**, 403–34. [36](#)
- [46] Girvan, M. and Newman, M. E. J. (2002). Community structure in social and biological networks. *Proceedings of the National Academy of Sciences*, **12**, 7821–6. [1.7](#)
- [47] Goldstein, R. E. and Ashcroft, N. W. (1985). Origin of the singular diameter in coexistence curve of a metal. *Physical Review Letters*, **55**, 2164–7. [2](#)
- [48] Gomes, C. P. and Selman, B. (2002). Satisfied with physics. *Science*, **297**, 784–5. [8.15](#)
- [49] Gomes, C. P., Selman, B., Crato, N., and Kautz, H. (2000). Heavy-

- tailed phenomena in satisfiability and constraint satisfaction problems. *Journal of Automated Reasoning*, **24**, 67–100. [8.15](#)
- [50] Goss, P. J. E. and Peccoud, J. (1998). Quantitative modeling of stochastic systems in molecular biology by using stochastic Petri nets. *Proceedings of the National Academy of Sciences*, **95**, 6750–5. [8.10](#), [8.13](#)
- [51] Gottlieb, M. (1966). *Seven states of matter*. Walker & Company. [2](#)
- [52] Greiner, W., Neise, L., and Stöcker, H. (1995). *Thermodynamics and statistical mechanics*. Springer, New York. [3.11](#), [24](#)
- [53] Greywall, D. S. and Ahlers, G. (1973). Second-sound velocity and superfluid density in  $^4\text{He}$  under pressure near  $T_\lambda$ . *Physical Review A*, **7**, 2145–62. [12.14](#)
- [54] Guggenheim, E. A. (1945). The principle of corresponding states. *Journal of Chemical Physics*, **13**, 253–61. [12.6](#)
- [55] Hänggi, P., Talkner, P., and Borkovec, M. (1990). Reaction-rate theory: fifty years after Kramers. *Reviews of Modern Physics*, **62**, 251. [35](#), [6.11](#)
- [56] Heller, P. and Benedek, G. B. (1962). Nuclear magnetic resonance in  $\text{MnF}_2$  near the critical point. *Physical Review Letters*, **8**, 428–32. [12.6](#)
- [57] Hirth, J. P. and Lothe, J. (1982). *Theory of dislocations*, 2nd edition. John Wiley & Sons Inc, New York. [11.15](#)
- [58] Hodgdon, J. A. and Sethna, J. P. (1993). Derivation of a general three-dimensional crack-propagation law: A generalization of the principle of local symmetry. *Physical Review B*, **47**, 4831–40. [9.6](#)
- [59] Houle, P. A. and Sethna, J. P. (1996). Acoustic emission from crumpling paper. *Physical Review E*, **54**, 278. [1](#)
- [60] Hu, W. (2001). Ringing in the new cosmology (introduction to the acoustic peaks and polarization). <http://background.uchicago.edu/~whu/intermediate/intermediate.html>. [7.15](#), [10.1](#), [10.1](#)
- [61] Hull, J. C. (2005). *Options, futures, and other derivatives*. Prentice Hall, Upper Saddle River, NJ. [38](#)
- [62] Jacobsen, J., Jacobsen, K. W., and Sethna, J. P. (1997). Rate theory for correlated processes: Double-jumps in adatom diffusion. *Physical Review Letters*, **79**, 2843. [6.11](#)
- [63] Jarzynski, C. (1997). Nonequilibrium equality for free energy differences. *Physical Review Letters*, **78**, 2690–3. [6.8](#)
- [64] Jensen, R. V. and Myers, C. R. (1985). Images of the critical points of nonlinear maps. *Physical Review A*, **32**, 1222–4. [22](#), [4.3](#), [4.5](#), [4.3](#)
- [65] Kardar, M., Parisi, G., and Zhang, Y.-C. (1986). Dynamic scaling of growing interfaces. *Physical Review Letters*, **56**, 889–92. [9.6](#)
- [66] Khinchin, A. I. (1957). *Mathematical foundations of information theory*. Dover, New York. [5.17](#)
- [67] Kivelson, P. D. (2002). Neur-on. <http://www.neur-on.com>. [12.18](#)
- [68] Kuntz, M. C., Houle, P., and Sethna, J. P. (1998). Crackling noise.



- <http://simsience.org/>. 8.14, 1, 12.3, 12.13
- [69] Kuntz, M. C., Perković, O., Dahmen, K. A., and Sethna, J. P. (1999). Hysteresis, avalanches, and noise: Numerical methods. *Computing in Science and Engineering*, **1**, 73–81. 43, 45, 8.14
- [70] Landau, L. D. and Lifshitz, E. M. (1965). *Quantum mechanics, non-relativistic theory*, 2nd edition. Pergamon Press, Oxford. 42
- [71] Landau, L. D. and Lifshitz, E. M. (1980). *Statistical physics*. Butterworth Heinemann, Oxford. 31, 12
- [72] Lang, J. M., Audier, M., Dubost, B., and Sainfort, P. (1987). Growth morphologies of the Al-Li-Cu icosahedral phase. *Journal of Crystal Growth*, **83**, 456–65. 9.1
- [73] Langer, J. S. (1969). Statistical theory of the decay of metastable states. *Annals of Physics (NY)*, **54**, 258–75. 9
- [74] Langer, J. S. (1980). Instabilities and pattern formation in crystal growth. *Reviews of Modern Physics*, **52**, 1–28. 11.9
- [75] Langer, S. A., Grannan, E. R., and Sethna, J. P. (1990). Nonequilibrium entropy and entropy distributions. *Physical Review B*, **41**, 2261. 5.18
- [76] Langer, S. A. and Sethna, J. P. (1986). Textures in a chiral smectic liquid crystal film. *Physical Review A*, **34**, 5305. 30
- [77] Langer, S. A. and Sethna, J. P. (1988). Entropy of glasses. *Physical Review Letters*, **61**, 570. (M. Goldstein noticed the bounds earlier). 5.11
- [78] Last, B. J. and Thouless, D. J. (1971). Percolation theory and electrical conductivity. *Physical Review Letters*, **27**, 1719–21. 1
- [79] Lebowitz, J. L. and Penrose, O. (February 1973). Modern ergodic theory. *Physics Today*, 23–9. 3, 9
- [80] Libbrecht, K. (2003). Snowflakes: photographed by Kenneth Libbrecht. <http://snowcrystals.com>. 11.22, B
- [81] Libbrecht, K. and Rasmussen, P. (2003). *The snowflake: winter's secret beauty*. Voyageur Press, Stillwater, MN. 11.4.3, 11.22
- [82] Liphardt, J., Onoa, B., Smith, S. B., Tinoco, I., and Bustamante, C. (2001). Reversible unfolding of single RNA molecules by mechanical force. *Science*, **292** (5517), 733–7. 6.12, 6.13
- [83] Maier, R. S. and Stein, D. L. (1993). Escape problem for irreversible systems. *Physical Review E*, **48**, 931–38. 6.11
- [84] Malcai, O., Lidar, D. A., Biham, O., and Avnir, D. (1997). Scaling range and cutoffs in empirical fractals. *Physical Review E*, **56**, 2817–28. 12.13, 17
- [85] Malkiel, B. G. (2003). *The random walk guide to investing: ten rules for financial success*. Norton, New York. 2.3
- [86] Malkiel, B. G. (2004). *A random walk down Wall street*. Norton, New York. 2.3
- [87] Marković, N., Christiansen, C., and Goldman, A. M. (1998). Thickness–magnetic field phase diagram at the superconductor–insulator transition in 2D. *Physical Review Letters*, **81**, 5217–20. 12.15
- [88] Martin, P. C. (1968). Problème à n corps (many-body physics). In

- Measurements and correlation functions*, pp. 37–136. Gordon and Breach, New York. [1](#), [10.3](#)
- [89] Mathews, J. and Walker, R. L. (1964). *Mathematical methods of physics*. Addison-Wesley, Redwood City, CA. [54](#), [55](#), [9.4](#), [10.8](#)
- [90] McGath, G. and Buldyrev, S. (1996). The self-avoiding random walk. <http://polymer.bu.edu/java/java/saw/saw.html>. BU Center for Polymer Studies. [9](#), [2.10](#)
- [91] Mermin, N. D. (1979). The topological theory of defects in ordered media. *Reviews of Modern Physics*, **51**, 591–648. [9.1](#)
- [92] Mézard, M., Parisi, G., and Zecchina, R. (2002). Analytic and algorithmic solution of random satisfiability problems. *Science*, **297**, 812. [8.15](#)
- [93] Monasson, R., Zecchina, R., Kirkpatrick, S., Selman, B., and Troyansky, L. (1999). Determining computational complexity from characteristic ‘phase transitions’. *Nature*, **400**, 133–7. [8.15](#)
- [94] Nemenman, I., Shafee, F., and Bialek, W. (2002). Entropy and inference, revisited. In *Advances in neural information processing systems*, pp. 471–8. MIT Press, Cambridge. [6.8](#)
- [95] Newman, M. E. J. (2000). Models of the small world. *Journal of Statistical Physics*, **101**, 819–41. [1.7](#)
- [96] Newman, M. E. J. (2001). Scientific collaboration networks. II. Shortest paths, weighted networks, and centrality. *Physical Review E*, **64**, 016132. [1.7](#)
- [97] Newman, M. E. J. (2005). Power laws, Pareto distributions and Zipf’s law. *Contemporary Physics*, **46**, 323–51. <http://arXiv.org/abs/cond-mat/0412004/>. [15](#)
- [98] Newman, M. E. J. and Barkema, G. T. (1999). *Monte Carlo methods in statistical physics*. Oxford University Press. [8.8](#)
- [99] Newman, M. E. J. and Watts, D. J. (1999). Renormalization-group analysis of the small-world network model. *Physics Letters A*, **263**, 341–6. [1.7](#)
- [100] Nielsen, O. H., Sethna, J. P., Stoltze, P., Jacobsen, K. W., and Nørskov, J. K. (1994). Melting a copper cluster: Critical-droplet theory. *Europhysics Letters*, **26**, 51–6. [45](#)
- [101] Nova (2000). Trillion dollar bet. <http://www.pbs.org/wgbh/nova/stockmarket/>. [2.12](#)
- [102] Onsager, L. (1969). Motion of ions—principles and concepts. *Science*, **166** (**3911**), 1359. (1968 Nobel Prize lecture). [10.8](#)
- [103] Parisi, G. (1988). *Statistical field theory*. Perseus, Redding, MA. [25](#)
- [104] Penrose, R. (1989). *The emperor’s new mind*. Oxford University Press. (No endorsement of his more speculative ideas implied). [11](#)
- [105] Poon, L. Cat map. University of Maryland Chaos Group, <http://www-chaos.umd.edu/misc/catmap.html>. [5.16](#)
- [106] Press, W. H., Teukolsky, S. A., Vetterling, W. T., and Flannery, B. P. (2002). *Numerical recipes in C++ [C, Fortran, ...], the art of scientific computing*, 2nd ed. Cambridge University Press. [59](#)
- [107] Rajagopal, K. and Wilczek, F. (2001). Enforced electrical neutral-

- ity of the color-flavor locked phase. *Physical Review Letters*, **86**, 3492–5. [7.16](#)
- [108] Ralls, K. S. and Buhrman, R. A. (1991). Microscopic study of 1/f noise in metal nanobridges. *Physical Review B*, **44**, 5800–17. [10.17](#)
- [109] Ralls, K. S., Ralph, D. C., and Buhrman, R. A. (1989). Individual-defect electromigration in metal nanobridges. *Physical Review B*, **40**, 11561–70. [10.16](#)
- [110] Rasmussen, K. O., Cretegny, T., Kevrekidis, P. G., and Gronbech-Jensen, N. (2000). Statistical mechanics of a discrete nonlinear system. *Physical Review Letters*, **84**, 3740. [20](#)
- [111] Rottman, C., Wortis, M., Heyraud, J. C., and Métois, J. J. (1984). Equilibrium shapes of small lead crystals: Observation of Pokrovsky–Talapov critical behavior. *Physical Review Letters*, **52**, 1009–12. [11.6](#)
- [112] Rutenberg, A. D. and Vollmayr-Lee, B. P. (1999). Anisotropic coarsening: Grain shapes and nonuniversal persistence exponents. *Physical Review Letters*, **83**, 3772–5. [11.10](#)
- [113] Sander, E. Marlowe the cat starring in the Arnol'd cat map movie. <http://math.gmu.edu/~sander/movies/arnold.html>. [5.16](#)
- [114] Schroeder, D. V. (2000). *Thermal physics*. Addison-Wesley Longman, San Francisco. [2.9](#)
- [115] Schwarz, U. T., English, L. Q., and Sievers, A. J. (1999). Experimental generation and observation of intrinsic localized spin wave modes in an antiferromagnet. *Physical Review Letters*, **83**, 223. [20](#)
- [116] Selman, B., Krautz, H., and Cohen, B. (1996). Local search strategies for satisfiability testing. *Dimacs Series in Discrete Mathematics and Theoretical Computer Science*, **26**, 521–32. [8.15](#)
- [117] Sethna, J. P. (1985). Frustration, curvature, and defect lines in metallic glasses and cholesteric blue phases. *Physical Review B*, **31**, 6278. [30](#), [12.18](#)
- [118] Sethna, J. P. (1992). Order parameters, broken symmetry, and topology. In *1991 lectures in complex systems: the proceedings of the 1991 complex systems summer school, Santa Fe, New Mexico*, Volume XV, pp. 243. Addison–Wesley. <http://www.lasp.cornell.edu/sethna/OrderParameters/Intro.html>. [2](#)
- [119] Sethna, J. P. (1995). Equilibrium crystal shapes. <http://www.lasp.cornell.edu/sethna/CrystalShapes>. [11.6](#)
- [120] Sethna, J. P. (1996). Jupiter! The three-body problem. <http://www.physics.cornell.edu/sethna/teaching/sss/jupiter/jupiter.htm>. [4.4](#), [4.4](#)
- [121] Sethna, J. P. (1997). Cracks and elastic theory. [http://www.lasp.cornell.edu/sethna/Cracks/Zero\\_Radius\\_of\\_Convergence.html](http://www.lasp.cornell.edu/sethna/Cracks/Zero_Radius_of_Convergence.html). [1.5](#)
- [122] Sethna, J. P. (1997). Quantum electrodynamics has zero radius of convergence. <http://www.lasp.cornell.edu/sethna/Cracks/QED.html>. [1.5](#),

- 1.5
- [123] Sethna, J. P. (1997). Stirling's formula for  $n!$  <http://www.lassp.cornell.edu/sethna/Cracks/Stirling.html>. 1.4
- [124] Sethna, J. P. (1997). What is coarsening? [http://www.lassp.cornell.edu/sethna/Coarsening/What\\_Is\\_Coarsening.html](http://www.lassp.cornell.edu/sethna/Coarsening/What_Is_Coarsening.html). 10.1, 10.2
- [125] Sethna, J. P. (1997). What is the radius of convergence? [http://www.lassp.cornell.edu/sethna/Cracks/What\\_Is\\_Radius\\_of\\_Convergence.html](http://www.lassp.cornell.edu/sethna/Cracks/What_Is_Radius_of_Convergence.html). 1.5, 5
- [126] Sethna, J. P. (2004). Entropy, order parameters, and complexity web site. <http://www.physics.cornell.edu/sethna/StatMech/>. 1.1, 1.7, 2.5, 6.8, 11.1, 11.7, 31
- [127] Sethna, J. P., Dahmen, K. A., and Kuntz, M. C. (1996). Hysteresis and avalanches. <http://www.lassp.cornell.edu/sethna/hysteresis/>. 12.13
- [128] Sethna, J. P., Dahmen, K. A., and Myers, C. R. (2001). Crackling noise. *Nature*, **410**, 242. 1, 12.5, 12.8, 12.13
- [129] Sethna, J. P. and Myers, C. R. (2004). *Entropy, Order Parameters, and Complexity* computer exercises: Hints and software. <http://www.physics.cornell.edu/sethna/StatMech/ComputerExercises.html>. (document), 1.6, 1.7, 1.7, 2.4, 2.10, 2.11, 2.13, 3.4, 3.12, 4.1, 22, 4.4, 6.1, 8.1, 8.2, 8.7, 8.8, 8.9, 8.11, 8.13, 8.15, 10.2, 10.6, 11.4, 11.6, 12.1, 12.12, 12.13, A.2, A.4, A.7, A.8
- [130] Sethna, J. P., Shore, J. D., and Huang, M. (1991). Scaling theory for the glass transition. *Physical Review B*, **44**, 4943. Paper based on discussions with Daniel Fisher, see erratum *Physical Review B* **47**, 14661 (1993). 9.8
- [131] Shannon, C. E. (1948). A mathematical theory of communication. *The Bell System Technical Journal*, **27**, 379–423. 32
- [132] Shore, J. D., Holzer, M., and Sethna, J. P. (1992). Logarithmically slow domain growth in nonrandom frustrated systems: Ising models with competing interactions. *Physical Review B*, **46**, 11376–404. 11.10
- [133] Sievers, A. J. and Takeno, S. (1988). Intrinsic localized modes in anharmonic crystals. *Physical Review Letters*, **61**, 970–3. 20
- [134] Siggia, E. D. (1979). Late stages of spinodal decomposition in binary mixtures. *Physical Review A*, **20**, 595. 11.9, 11.9
- [135] Swendsen, R. H. and Wang, J.-S. (1987). Nonuniversal critical dynamics in Monte Carlo simulations. *Physical Review Letters*, **58**, 86. 8.8
- [136] Tang, L.-H. and Chen, Q.-H. (2003). Finite-size and boundary effects on the I–V characteristics of two-dimensional superconducting networks. *Physical Review B*, **67**, 024508. 22
- [137] Team, NASA/WMAP Science (2004). Wilkinson microwave anisotropy probe. <http://map.gsfc.nasa.gov/index.html>. Note the wave animations at [http://map.gsfc.nasa.gov/m\\_or/mr\\_media2.html](http://map.gsfc.nasa.gov/m_or/mr_media2.html). 7.15, 10.13, 10.14, 10.1

- [138] Thomas, S. B. and Parks, G. S. (1931). Studies on glass VI. some specific heat data on boron trioxide. *Journal of Physical Chemistry*, **35**, 2091–102. [5.18](#)
- [139] Toner, J. and Tu, Y. (1995). Long-range order in a two-dimensional dynamical XY model: How birds fly together. *Physical Review Letters*, **75**, 4326–9. [9.6](#)
- [140] Toyoshima, C., Nakasako, M., Nomura, H., and Ogawa, H. (2000). Crystal structure of the calcium pump of sarcoplasmic reticulum at 2.6 Angstrom resolution. *Nature*, **405**, 647–55. [5.6](#)
- [141] Trefethen, L. N. and Trefethen, L. M. (2000). How many shuffles to randomize a deck of cards? *Proceedings of the Royal Society of London A*, **456**, 2561–8. [5.13](#)
- [142] Watts, D. J. and Strogatz, S. H. (1998). Collective dynamics of ‘small-world’ networks. *Nature*, **393**, 440–42. [1.7](#), [1.7](#)
- [143] Weinberg, S. (1977). *The first three minutes*. Basic Books (Perseus), New York. [11](#), [51](#), [10.1](#)
- [144] Wells, H. G. (1895). *The time machine*. Online, several places. [11](#)
- [145] Wigner, E. (1960). The unreasonable effectiveness of mathematics in the natural sciences. *Communications in Pure and Applied Mathematics*, **13**, 1–14. <http://www.dartmouth.edu/~matc/MathDrama/reading/Wigner.html>. [1](#)
- [146] Wolff, U. (1989). Collective Monte Carlo updating for spin systems. *Physical Review Letters*, **62**, 361. [8.8](#)
- [147] Yeomans, J. M. (1992). *Statistical mechanics of phase transitions*. Oxford University Press. [8.3](#)
- [148] Zinn-Justin, J. (1996). *Quantum field theory and critical phenomena (3rd edition)*. Oxford University Press. [12.6](#)
- [149] Zunger, A., Wang, L. G., Hart, G. L. W., and Sanatai, M. (2002). Obtaining Ising-like expansions for binary alloys from first principles. *Modelling and Simulation in Materials Science and Engineering*, **10**, 685–706. [8.3](#)



# Index

Index entry format examples:

- Figure captions: f5.6 84 would be in Fig. 5.6 on p. 84.
- Exercises: e5.15 102 would be in Exercise 5.15 on p. 102.
- Notes and footnotes: n31 88 would be in note 31 on p. 88.

2SAT, *see* Logical satisfiability

3SAT, *see* Logical satisfiability

Abrupt phase transitions, 241–61

3SAT, e8.15 189

critical droplet, *see* Critical droplet

discontinuity in properties, 241

double-well free energy density,  
f11.2 242

droplet fluctuation precursors, n2 241

equal-area construction, f11.3 244,  
243–4

makes sense only in mean field,  
n11 244

Ising model, e8.1 174, e11.4 253

jumps in first derivatives of free  
energies, 243

latent heat, n3 241

related to entropy change, 243

no precursors, 241

nucleation, *see* Nucleation

often called first order, 243

phase coexistence, constant volume,  
energy, 241

Absorption

balance with emission, e7.7 155

of light, Einstein coefficient, e7.8 155

AC, frequency dependent, from  
'alternating current', n15 222

Accuracy of numerical solution to  
dynamical system, e3.12 59

Adiabatic

addition of particle, and chemical  
potential, 112

avoiding entropy increase, 49, 51

avoiding fast motions which generate  
entropy, 49, 78

bulk modulus, and sound, n56 160

definition, 49

expansion of Universe and microwave  
background radiation,  
e7.15 160

no heat exchange, 49

pressure measurement, 50

steps in Carnot cycle, f5.3 79

usage just excluding heat flow, n22 115

Adiabatic continuity, n28 173

and phases, 171–3

basis for theoretical physics, 173

experimental method to determine  
phase, 173

not definition of phase, but almost,  
173

not the only criterion for good  
theories, n29 173

water to oil through alcohol, f8.8 173

Air, as ideal gas with conserved  
momentum, sound, 220

Algorithm

avalanche propagation, e8.13 184

bits, for magnetic hysteresis, e8.14 186

brute-force, for magnetic hysteresis,  
e8.13 184

cluster flip, e8.8 177, e8.9 177

cluster-flip

implementation, e8.9 177

Davis–Putnam, for logical

satisfiability, e8.15 187

equilibration guaranteed if Markov,  
ergodic and detailed balance,  
171

Euler method, solving PDE not ODE,  
e3.12 59

general-purpose, for solving ODE,  
e3.12 60

implicit, for solving stiff ODE, e3.12 60

Monte Carlo

as Markov chain, 167

Bortz–Kalos–Lebowitz, n36 179

continuous-time, n36 179

gambling center in Monaco, n12 166

Gillespie, chemical reactions,  
e8.10 179, e8.11 180

heat bath, 166, e8.7 176

Ising model, 166

Metropolis, e8.6 176, e8.7 176

renormalization group, 269

Swendsen–Wang, e8.8 177

Wolff, e8.8 177, e8.9 177

order  $N$  bits per spin, hysteresis  
model, e8.14 186

order  $N \log N$  vs.  $N^2$ , hysteresis  
model, e8.14 185

sort

order  $N \log N$ , e8.14 185

use package, n46 185

sorted-list, for magnetic hysteresis,  
e8.14 185

Verlet: conserves symplectic form,  
n61 59

Allosteric, definition, n63 132

Alloy phase diagram, from lattice  
simulations, 165

Ammonia synthesis, Haber–Bosch  
process, n29 118

Analyticity

and phases, 171–3

breakdown at superconducting  $T_c$ ,  
e12.8 286

fails at phase transitions, n32 208

free energy density, vs. free energy,  
n32 208

free energy, for finite systems, n32 208

from causality, 230

three origins of, n27 230

Anharmonic localized modes, breakdown  
of ergodicity, 68

Anharmonic phonons (Fermi, Pasta,  
Ulam), breakdown of

ergodicity, 68

Antiferromagnet, 164

Antimatter beings and entropy increase,  
n8 80

Antiparticles, as backward in time,  
f7.3 141

Anyon statistics, n12 140

- Apoptosis: programmed cell death, e8.11 **180**
- Arbitrage (free money to be made), e2.12 **33**
- Arnol'd  
cat map, e5.8 **95**, f5.16 **96**  
diffusion, n33 **75**
- Arrhenius law  
as origin of slow processes, n37 **121**  
deriving prefactor, e6.11 **129**  
for nucleation rate, 245  
for reaction rate, 120
- Arrow of time, and entropy increase, 80
- Astrophysics exercises, e2.2 **26**, e4.4 **72**, e5.1 **191**, e5.4 **93**, e7.15 **159**, e7.16 **161**, e10.1 **231**
- Asymptotic series, e1.5 **7**  
and perturbation theory, 172  
quantum electrodynamics, and Hooke's law, e1.5 **8**
- Atmosphere  
thins exponentially, 22  
thins non-exponentially in outer space, e3.3 **54**
- Atomic physics exercises, e7.9 **156**, e7.13 **158**, e7.14 **158**
- ATPase as Maxwell's demon, f5.6 **83**
- Attractor, e12.9 **288**  
fixed-point, e4.2 **70**, e4.3 **71**  
not in Hamiltonian systems, 65  
periodic, e12.9 **288**  
strange  
dimensions, e5.16 **101**  
for Feigenbaum map at  $\mu_c$ , e5.16 **101**
- Avalanche, f12.5 **266**  
and hysteresis  
scale invariance at  $R_c$ , f12.11 **273**  
as jump in  $M(H)$  curve, f8.16 **183**  
hysteresis, e8.13 **182**  
Barkhausen noise, e8.13 **182**  
propagation algorithm, e8.13 **184**, f8.17 **184**  
size distribution, e12.13 **296**  
scaling form, e12.13 **297**  
scaling function, 276–7  
scaling function at  $R_c$ , 272–4  
scaling function away from  $R_c$ , f12.13 **276**  
time series during, f8.18 **184**
- Avalanches and hysteresis, e8.14 **185**, e12.13 **296**  
bits algorithm, e8.14 **186**  
sorted-list algorithm, e8.14 **185**
- Average, ensemble  
denoted by angle brackets  $\langle \cdot \rangle$ , n2 **16**, 220  
equal-time denoted  $\langle \cdot \rangle_{\text{eq}}$ , 220  
evolving denoted by  $\langle \cdot \rangle_{\text{ev}}$ , 220  
of evolution from fixed initial condition  $[\cdot]_{p_i}$ , 220
- Avogadro's number, n15 **40**
- Axiomatic thermodynamics, 115
- $\beta$ -brass, as binary alloy, 165
- Bacteria, red and green, Markov chain, e8.4 **175**
- Bandwidth, definition, n44 **237**
- Bardeen–Cooper–Schrieffer theory, *see* BCS theory, of superconductors
- Barkhausen noise, magnetic, e8.13 **182**, f8.14 **183**  
scale invariance at  $R_c$ , f12.11 **273**
- Baryons, mesons, 8-fold way, from group representation theory, 306
- Bayes' theorem, e6.14 **133**
- Bayesian statistics, e6.14 **133**
- BCS theory, of superconductors  
and the renormalization group, e12.8 **286**  
quantitative, not just adiabatic, n29 **173**
- Bekenstein and black-hole thermodynamics, e5.4 **94**
- Biaxial nematic, defect entanglement theory, 202
- Bifurcation  
Hopf, e12.4 **284**  
non-analyticity in attractor evolution, n23 **283**  
period-doubling, and onset of chaos, e12.9 **288**  
pitchfork, e12.4 **283**, f12.19 **283**  
saddle-node, e12.4 **283**  
theory, and phase transition, 279–80, e12.4 **283**, e12.9 **288**  
transcritical exchange of stability, e12.4 **283**
- Big Bang, and microwave background radiation, e7.15 **159**, e10.1 **231**
- Billiards, entropy increase and arrow of time, 80
- Binary alloy, f8.3 **165**, 165  
atomic relaxation, 165  
 $\beta$ -brass, 165  
explicit mapping to Ising Hamiltonian, n8 **165**  
Hamiltonian, 165  
Ising model in disguise, 165  
thermal position fluctuations, n9 **165**  
three-site, long-range interactions, 165
- Binomial coefficient  $\binom{p}{q} = p!/(q!(p-q)!)$ , n16 **40**, e3.9 **57**
- Biology exercises, e2.3 **26**, e6.4 **126**, e6.12 **131**, e8.10 **178**, e8.11 **179**
- Black hole  
negative specific heat, e5.4 **94**  
neutron star collapse into, e7.16 **161**  
thermodynamics, e5.4 **93**
- Black–Scholes model of derivative pricing, e2.12 **32**
- Black-body radiation, f7.8 **148**, 147–8  
and stimulated emission, e7.8 **155**  
and the cosmic microwave background, f7.17 **159**, e10.1 **231**  
emission from hole, e7.7 **154**  
energy gap, 148  
equipartition theorem wrong for, 148  
ultraviolet catastrophe, 147  
why black?, n34 **148**, e7.7 **154**
- Bloch's theorem, 151
- Blood pressure, salt, and osmotic pressure, f5.6 **83**
- Boltzmann distribution, 44  
canonical ensemble, 106  
derived using ideal gas law, e6.1 **124**  
grand canonical ensemble, 112  
ideal gas momenta, 44
- Boltzmann equation  
and diffusion equation under gravity, n20 **22**
- Boltzmann's constant  $k_B$ , unit conversion, n25 **44**, n34 **45**, e3.1 **54**
- Boltzmann's ergodic hypothesis, 65  
violated by planetary motion, e4.4 **74**
- Boltzmann's ergodic theorem, *see* Boltzmann's ergodic hypothesis
- Bond percolation, e2.13 **33**, f2.12 **33**  
 $p_c$  and near  $p_c$ , f12.2 **264**
- Bond vs. site percolation, e2.13 **35**, f12.7 **268**
- Bortz–Kalos–Lebowitz algorithm, n36 **179**
- Bose condensation, 148–50  
analogy with superfluid, 150, e9.7 **210**  
first experiment, Wieman and Cornell, 1995, e7.14 **158**  
flood when chemical potential 'river' rises above field, n21 **143**  
harmonic external potential, e7.14 **159**  
low-energy continuum states cannot absorb extra bosons, 150, e7.13 **158**  
macroscopically occupied quantum state, e9.7 **211**  
order parameter  $\psi(r)$ , e9.7 **211**  
specific heat cusp at  $T_c$ , f8.6 **171**  
superposition of different particle numbers, n38 **212**  
temperature near superfluid transition in  $\text{He}^4$ , 150  
temperature near theory estimate for Rb gas, e7.14 **158**
- Bose statistics, 140–1  
democratic, 145  
Maxwell–Boltzmann at low occupancy, high  $T$ , 143  
symmetric wavefunctions, 140



- Bose–Einstein condensation, *see* Bose condensation
- Bose–Einstein distribution, occupation of non-interacting states, f7.4 [142](#), [143](#)
- Boson
- free, [146–50](#)
  - gregarious, e7.9 [156](#)
  - integer spin, n13 [140](#)
  - meson,  $\text{He}^4$ , photon, phonon, gluon,  $W^\pm$ ,  $Z$ , graviton, n13 [140](#)
  - more likely to join multiply occupied states, e7.9 [156](#)
  - non-interacting, [142–3](#)
    - grand canonical ensemble, [142](#)
    - grand free energy, [142](#)
    - grand partition function, [142](#)
    - occupation, [143](#)
    - utility, [144](#)
  - one per excitation of harmonic oscillator, e7.2 [152](#)
  - phonon, photon, n13 [140](#), [143](#), e7.2 [152](#)
- Breadth-first search, e2.13 [34](#)
- Breathing
- chemical potential of  $\text{CO}_2$  in blood, n42 [48](#)
  - oxygen depletion on mountain tops, 22, e6.1 [124](#)
- Brillouin zone, and Fourier analysis, n8 [301](#)
- Broken symmetry, [192](#)
- and Landau theory, e9.5 [206](#)
  - gauge invariance, in superconductors, [197](#)
  - gauge invariance, in superfluids, [197](#)
  - Ising model, e9.5 [208](#)
  - not definition of phase, but almost, n2 [192](#)
  - not in 2D (Mermin–Wagner theorem), n12 [198](#)
- orientational
- crystal, [69](#), [192](#)
  - Heisenberg magnet, f9.9 [197](#)
  - liquid crystal, f9.10 [197](#)
- quasicrystalline, f9.1 [191](#)
- time-reversal invariance in magnets, n4 [193](#)
- translational
- crystal, [69](#), [192](#), n38 [233](#)
  - implies sound waves, [196](#)
  - none for two-dimensional crystal, n39 [235](#)
  - 2D crystal orientations, n12 [198](#)
  - violates ergodicity, [68](#)
- Brute-force algorithm, magnetic hysteresis, e8.13 [184](#)
- Burger’s vector
- counts circumnavigations through/around order parameter space, [200](#)
  - counts extra rows and columns of atoms, [198](#)
  - hexagonal crystal, f11.15 [254](#)
  - topological, [198](#), [199](#)
- Burridge–Knopoff model of earthquakes, f12.4 [265](#)
- Butterfly effect, e5.9 [96](#)
- Calcium ATPase as Maxwell’s demon, f5.6 [83](#)
- Call option, e2.12 [32](#)
- American vs. European style, n38 [32](#)
- Canonical ensemble, f6.1 [106](#), [106–11](#)
- as partial trace, n5 [107](#)
  - Boltzmann distribution, [106](#)
  - comparing Bose, Fermi, Maxwell–Boltzmann, distinguishable, [145](#), e7.1 [152](#)
  - definition, [107](#)
  - entropy, [108](#)
  - equivalent to microcanonical, [108](#), e6.3 [126](#)
  - for non-interacting systems, [109–11](#)
  - free energies add for uncoupled systems, [109](#)
  - harmonic oscillator
    - classical, [111](#)
    - quantum, [139](#)
  - Helmholtz free energy, [108](#)
  - ideal gas, [110](#)
  - internal energy, [107](#)
  - Lagrange multiplier, e6.6 [128](#)
  - more convenient than microcanonical, [109](#)
  - no negative temperature, e6.3 [125](#)
  - partition function, [106](#)
  - quantum,  $\rho = e^{-\beta\mathcal{H}}/(\text{Tr } e^{-\beta\mathcal{H}})$ , [137](#)
  - specific heat, [107](#)
  - uncoupled systems figure, f6.2 [109](#)
  - velocity distribution, classical, [111](#)
- Canonical, Oxford English dictionary definition, n1 [105](#)
- Capacity dimension, fractal, e5.16 [101](#)
- Carathéodory and axiomatic thermodynamics, [115](#)
- Card shuffling, entropy increase, e5.13 [99](#)
- Carlson–Langer model of earthquakes, f12.4 [265](#)
- Carnot cycle, [78–80](#)
- and perpetual motion machines, f5.1 [78](#)
  - avoiding irreversible processes, [78](#)
  - four steps, [78](#)
  - $P$ – $V$  diagram, f5.3 [79](#)
  - refrigerator efficiency bound, e5.6 [95](#)
  - reversible engines all equivalent, [79](#)
- Cast iron, and coarsening, [246](#)
- carbon precipitates, [246](#)
- Cat map, Arnol’d, e5.8 [95](#), f5.16 [96](#)
- Catalyst, definition, n29 [118](#)
- Cauchy’s integral formula, n28 [230](#)
- Cauchy’s theorem, f10.11 [230](#)
- $\oint_C f(z') dz' = 0$ , [230](#)
  - needed to Fourier transform Gaussian, n25 [24](#)
- Causality
- Kramers–Krönig relation, [229–31](#)
  - response after kick, [229](#)
  - susceptibility zero for  $t < 0$ , [226](#)
  - ties real and imaginary susceptibility, [229–31](#)
- Central dogma of biology, e8.11 [179](#)
- Central limit theorem, f1.1 [2](#), f2.6 [24](#), e2.5 [28](#), e12.11 [291](#)
- and Green’s function for diffusion equation, [25](#)
  - renormalization-group derivation, e12.11 [291](#)
  - stocks disobey, heavy tails, e2.11 [31](#)
- Chaos, [279](#)
- and planetary dynamics, e4.4 [72](#)
  - Hamiltonian systems, vs. KAM tori, f4.3 [66](#)
  - justifies microcanonical average, [38](#)
  - necessitates ensemble methods, [38](#)
  - onset of, e12.9 [288](#)
  - scrambles trajectory to equilibrium, n7 [38](#)
  - sensitive dependence on initial conditions, [38](#), e5.9 [96](#)
  - stretching and folding, [65](#), e5.9 [97](#)
  - Arnol’d cat map, e5.8 [95](#)
  - logistic map, e5.9 [96](#), e12.9 [288](#)
  - three-body problem, e4.4 [75](#)
- Chemical concentrations, denoted by  $[\ ]$ , [118](#), e8.10 [178](#)
- Chemical equilibrium, [118–20](#)
- constant thermally activated, [120](#)
  - mass-action law, [118](#)
  - naive motivation, [118](#)
- Chemical potential
- and Bose condensation, f7.9 [149](#), [150](#)
  - and osmotic pressure, [48](#)
  - as ‘force’ on particle number, [48](#)
  - as Lagrange multiplier, e6.6 [128](#)
  - as variational derivative  $\delta\mathcal{F}/\delta\rho$ , [219](#)
  - bosons, never larger than  $\epsilon_0$ , [143](#), [149](#)
  - $\text{CO}_2$ , blood, and breathing, n42 [48](#)
  - convenient for quantum non-interacting systems, [142](#)
  - decreases with  $T$ , so occupancy usually falls as  $T$  rises, n20 [143](#)
  - energy change for adding particle  $(\partial E/\partial N)|_{S,V}$ , [48](#), [112](#)
  - equal at phase coexistence, e6.10 [129](#), [242](#), e11.3 [252](#)
  - equal when number shifts to maximize entropy, [47](#), f3.3 [47](#)

- from entropy,  $\mu = -T(\partial S/\partial N)|_{E,V}$ , 47
- gradient as force on particle, 122
- grand canonical ensemble, 112
- intensive variable, 46, e6.9 129
- microcanonical, 47–8
- non-interacting fermions, separates filled from empty at low  $T$ , 143
- number pressure for particles, 122, n21 143, 144
- occupation of non-interacting Bose, Fermi states, f7.4 142
- semiconductors, e7.12 157
- unfamiliar to most, 48
- van der Waals, e11.3 252
- varied to fix total number  $N$ , 143, 150, e7.1 152
- zero for harmonic oscillator as boson, 147, e7.2 152
- Chemical reaction, f6.6 118, 118–21
- dimerization, e8.10 178
- Haber–Bosch process, n29 118
- network
- biologist’s view, f8.12 180
  - computational view, f8.13 181
  - dimerization reaction, f8.11 178
- number fluctuations in small volume of cell, e8.10 178
- reaction coordinate, 120
- stochastic
- compared to continuous, e8.10 179, e8.11 181
  - Gillespie algorithm, e8.10 179, e8.11 180
- transition state, 120
- Chemical reaction rates, 120–1
- dynamical corrections, n35 120
  - thermally activated, 120
- Chemistry exercises, e6.8 128, e6.9 129, e6.10 129, e6.11 129, e11.1 251, e11.2 252, e11.3 252
- Chemotaxis, and random walks, 25
- Choose  $p$  from  $q$ ,  $\binom{p}{q} = p!/(q!(p-q)!)$ , n16 40, e3.9 57
- Circulation, of superfluid, quantized, e9.7 211
- Clausius–Clapeyron equation
- $$dP/dT = (s_1 - s_2)/(v_1 - v_2),$$
- e6.10 129
- Cloud
- droplet nucleation, 244
  - seeding, with ice-nucleating bacteria, n16 246
- Cluster, percolation, e2.13 34
- infinite, e12.12 294
  - size distribution, e12.12 293
- Cluster-flip algorithm, e8.8 177
- implementation, e8.9 177
- Co-dimension, n8 271
- Coarse-graining, 268
- and fractal dimension, n10 274
  - blurring of eyes, 272
  - energy, for Fermi liquids and superconductors, e12.8 286
  - free energy, 105, 121–3
  - ideal gas, 121, f6.8 121, f6.9 122
  - Ising model decimation, f12.9 270
  - pairwise sums and central limit theorem, e12.11 291
  - removing intermediates from chemical reaction pathways, e6.12 131
  - time, and onset of chaos, 279, e12.9 288, e12.9 290
- Coarsening, f10.1 216, 246–50
- and spinodal decomposition, n10 243
  - conserved order parameter, f11.9 248
  - interface velocity  $\propto \partial\mu/\partial x \propto 1/R^2$ , 248
  - $L(t) \propto t^{1/3}$ , 249
  - salad dressing, cast iron, rocks, 248
- correlation function scaling, e12.3 282
- driven by surface tension, 247
- exponents more universal, 250
- hydrodynamic flow, 249
- ice crystal, snowflake model, e11.9 259
- Ising model, 247, f11.7 247, e11.6 255
- length scale  $L(t)$
- diverges with time, 247
  - measured by interfacial area, energy, e11.6 255
  - smallest original feature not yet gone, 247
- logarithmic, from diverging barriers, 249, f11.10 249
- non-conserved order parameter, f11.8 248
- interface velocity  $\propto$  traction, 248
  - Ising, 248, e11.6 255
  - $L(t) \propto t^{1/2}$ , 248, e11.6 255
  - single-phase polycrystal, 248
- non-universal, 250
- non-universal scaling, e12.3 282
- polycrystals, 247
- salad dressing, cast iron, rocks, 246
- surfacediffusion*,  $L(t) \propto t^{1/4}$ , 249
- surface morphology, f10.2 216
- theory simplistic, 247
- COBE Planck distribution, of cosmic microwave background radiation, f7.17 159
- Coin flips, 15–16
- Markov chain, e8.3 175
  - waiting for Godot, e8.3 175
- Cold rock, cannot extract useful work from, 78
- Colorability, graph, e1.8 12
- Colored object, radiation from, e7.7 155
- Communications theory and entropy, 87, e5.15 100
- Compatibility condition, martensitic, e11.7 256
- Complexity exercises, e1.7 9, e2.13 33, e4.3 70, e5.9 96, e5.14 100, e5.16 101, e8.13 182, e8.14 185, e12.9 288, e12.12 293, e12.13 296
- Compression, data, and entropy, e5.14 100, e5.15 100
- Computation exercises, e1.7 9, e1.8 12, e2.4 27, e2.5 28, e2.10 30, e2.11 31, e2.13 33, e3.4 54, e3.12 58, e4.1 69, e6.1 124, e6.12 131, e8.1 174, e8.2 174, e8.6 176, e8.7 176, e8.8 177, e8.9 177, e8.10 178, e8.11 179, e8.13 182, e8.14 185, e8.15 186, e10.2 233, eA.2 307, eA.4 308, eA.7 310, eA.8 311
- Computation, no minimum cost for, e5.3 93
- Computational complexity, e8.15 186
- non-deterministic polynomial time NP factoring integers, e8.15 186
  - NP-complete, e8.15 186
  - logical satisfiability (SAT), e1.8 12, e8.15 187
  - traveling salesman, graph coloring, spin-glass ground state, 3SAT, e8.15 186
- $P = NP?$ , e8.15 187
- polynomial time P
- sorting lists, 2SAT, e8.15 186
  - testing if number is prime, e8.15 186
  - sorting  $N \log N$ , e8.15 186
- Computational statistical mechanics, 163–89
- Computer science exercises, e1.8 12, e5.2 91, e5.3 93, e5.14 100, e5.15 100, e8.15 186
- Condensed matter exercises, e2.10 30, e5.11 97, e5.12 98, e7.10 157, e7.11 157, e7.12 157, e9.1 203, e9.2 204, e9.3 205, e9.4 206, e9.5 206, e9.7 210, e9.8 211, e10.4 236, e10.5 236, e10.6 237, e10.8 238, e11.9 259, e12.2 282, e12.3 282, e12.5 284, e12.8 286
- Conditional probability, n38 89
- and entropy, 90, e5.17 102
- Conduction band, n39 151, e7.12 157
- Conductivity, DC, related to polarizability
- $$\sigma = \lim_{\omega \rightarrow 0} \omega \alpha''(\omega),$$
- 224
- Configuration space, n5 37
- Conjunctive normal form, and logical satisfiability, e1.8 13
- Connected correlation function, 219
- Conservation of energy, 77
- and the Carnot cycle, 79

- microcanonical ensemble, 38
- Conservation of particle number, locally violated by superfluids, superconductors, n5 195, e9.8 212
- Conservation, local, and currents, 20
- Conserved order parameter and current, 20, 64, 122, 248 always use to derive laws, n18 21
- Constitutive relations vs. free energy densities, n22 206
- Continuity equation, f2.5 21, f4.1 64
- Continuous phase transition, 263–82 2SAT, e8.15 189 crackling noise, 263 often called second order, 243 percolation, 263 singularities not usually jumps in second derivative of free energy, n7 243
- Continuous-time Monte Carlo, n36 179
- Controlled-not gate, and reversible computation, e5.3 93
- Convexity, n34 258 and Jensen's inequality, n36 88 entropy, downward, n37 46, f5.9 88, e8.12 182 free energy Landau theory ignores, f9.22 208 mean-field theory ignores, e12.5 284 not for martensites, 250, e11.8 258 vs. metastability, f11.2 242
- Convolution and product of Fourier transform, 303 closely related to correlation function, n13 303 Green's functions, 25, n12 303 sums of random variables, e1.2 6, e12.11 292, n12 303
- Cooling rubber band when stretched, e5.12 99
- Corner rounding transition, equilibrium crystal shape, f11.6 247, f11.10 249
- Correction to scaling, n2 266, 278, e12.2 282, e12.11 293
- Correlation function, 215–22 and power spectrum, 303 avalanche, e12.13 296 closely related to convolution, n13 303 connected, 219, e10.5 236 equal-time, 216, f10.4 217, f10.5 218, 218–20 ideal gas is white noise, 219 one-dimensional magnet, e10.8 239 proportional to static susceptibility  $\tilde{\chi}_0(\mathbf{k}) = \beta\hat{C}(\mathbf{k}, 0)$ , 225 equilibrium, 218–22, 224–9 relations to response, dissipation, 218 even under time reversal, 228 experimental probes, 217–18 extracts characteristic length, time, 216 measure of morphology, 216 measures influence on distant neighbors, 216 measures long-range order, 216 motivation, 215–17 pair distribution function, n6 217, e10.2 233 reduced analogous to superfluid density matrix, e9.8 212 related to susceptibility, fluctuation-dissipation theorem (classical)  $\chi''(\omega) = (\beta\omega/2)\tilde{C}(\omega)$ , 228 (quantum)  $\chi''(\mathbf{k}, \omega) = (1/2\hbar)(1 - e^{-\beta\hbar\omega})\tilde{C}(\mathbf{k}, \omega)$ , 229 same evolution law as initial condition, 221 scaling form, 277 coarsening, e12.3 282 scattering, 217 space–time, one-dimensional magnet, e10.8 239 telegraph noise, e10.5 236 time dependent general case, n12 221 ideal gas is Gaussian, 221 Ising model, e10.6 237 Onsager's regression hypothesis, 220–2 transform of absolute square of transform, 217, n22 225, e10.1 233, 303 two-state spin, e10.4 236
- Correlation length, f10.4 217 diverges at continuous phase transition, f10.4 217 exponential decay beyond, f10.5 218 power-law singularity at critical point, 266, 275 zero for white noise, n9 219
- Correlation time, *see* Critical slowing-down
- Correlation time, power-law singularity at critical point, 275
- Cosmic microwave background radiation, e7.15 159, e10.1 231 and absolute velocity of Sun, e10.1 232 correlation function, f10.14 232 fluctuation map, f10.13 232
- CPT invariance and entropy increase, n8 80
- Crackling noise at continuous transition, 263 crumpled paper, Rice Krispies<sup>TM</sup>, 263, e12.13 296 earthquakes, 263, f12.3 265, e12.13 296 magnets, e8.13 182, e12.13 296 random-field Ising model, e12.13 296 size distribution power law, 263
- Critical droplet, f11.4 244, 244–6 and equilibrium crystal shape, 246 balances surface tension vs. undercooling force, 245 barrier to nucleation, 245 dislocations under shear, e11.5 255 energy diverges at transition, 246, e11.5 255 ice crystal, snowflake model, e11.9 259 nucleation rate, 245, e11.4 253 radius diverges at transition, 246, e11.5 255 unstable state, 245
- Critical droplet theory calculates rare fluctuations, in tail, n14 246
- Critical exponent  $-2\nu$ , surface tension, 275  $1/(\sigma\nu)$ , fractal dimension, 274  $\alpha$  Feigenbaum, e12.9 290 specific heat, 275  $\beta$  generic, mean-field  $1/2$ , e9.5 208, 266, e12.5 284 Ising 2D  $1/8$ , e9.5 209 Ising, magnet, liquid–gas 0.325, e9.5 209, f12.6 267, e12.5 284 magnetization, 275 percolation, 2D is 5/36, e12.12 294 pitchfork bifurcation, e12.4 283 van der Waals,  $1/2$ , e11.2 252  $\delta$  Feigenbaum, e12.9 290 magnetization in field, 276  $\eta$ , correlation function, 275, e12.2 282  $\gamma$ , susceptibility, 275  $\nu$ , correlation length, 275, e12.2 282 percolation, 2D is 4/3, e12.12 295 random walk  $1/2$ , 19 self-avoiding random walk 3D 0.59, 2D  $3/4$ , 19, e2.10 31  $\sigma$ , cut-off in size distribution, 277, e12.13 297  $\tau$ , size distribution, 274, e12.12 294 percolation, 2D is 187/91, e12.12 294  $\bar{\tau} = \tau + \sigma\beta\delta$ , avalanche sizes, n13 274, e12.13 297  $\zeta = z\nu$ , correlation time, 275, e12.6 285 critical slowing-down, e12.6 285 from eigenvalues at fixed point, n17 276

- from eigenvalues at fixed-point, e12.7 286, e12.11 292
- irrational, at critical points in 3D, 266
- not the main predictions near critical points, 276
- rational, often in 2D, 266
- simple to measure, hard to measure well, 276, f12.13 276
- specialists talk in Greek letters, 276
- universal, 274
- wrong from Landau theory, e9.5 209
- wrong in mean-field theory, e12.5 284
- Critical point, 263–82
  - circling
    - from liquid to gas, f6.14 129, f8.4 166
    - from up-spin to down-spin, f8.5 166
  - dynamical systems, 279–80, e12.4 283
  - emergent scale invariance
    - avalanche  $R_c$ , f12.11 273
    - Ising  $T_c$ , f12.1 263
    - percolation  $p_c$ , n4 267
  - glass, theories of, 280–1
  - liquid–gas transition, 166
    - described exactly by Ising model, 166, 266
  - onset of chaos, e12.9 288
  - onset of lasing, e12.6 284
  - quantum, 278–9
  - van der Waals, e11.2 252
- Critical region, large near some transitions, f12.13 276
- Critical slowing-down, 275
  - cluster-flips bypass (Wolff algorithm), e8.8 177, e8.9 177
  - Ising model, e8.8 177, e8.9 177, 217
  - NP-complete problems, e8.15 188, 189
  - onset of lasing, e12.6 285
- Criticality, self-organized, f12.10 271, 272
- Crystal
  - coarsening and polycrystal grain size, 247
  - dislocation
    - Burger’s vector, f11.15 254
    - extra half-layer of atoms, 198
    - mediates bending, n15 200, e11.5 255
    - nucleation under stress, e11.5 254
    - topological defect, f9.11 198
  - flows like a liquid, but not in linear response, e11.5 255
  - no less amazing than superconductor, superfluid, 197
  - order parameter space is torus
    - $\mathbf{u}(\mathbf{r}) \in \mathbb{T}^d$ , f9.6 194, 195
- Curie’s law, e8.2 175
- Current
  - and local conservation, 20, 64, 122, 248
    - always use to derive laws, n18 21
  - quantum, from gradient of wavefunction, n36 211
- Curvature, and frustration in glassy systems, f12.18 281
- Dark energy, may lead to lonely Universe, e5.1 91
- Data compression, and entropy, 87, e5.14 100, e5.15 100
- Davis–Putnam algorithm, for logical satisfiability, e8.15 187
- de Broglie wavelength, quantum
  - related to thermal, n51 53
- de Broglie wavelength, thermal
  - and Bose condensation, 149
  - ideal gas entropy, 111
  - ideal gas Helmholtz free energy, 119, 121
  - ideal gas partition function, 110
  - microcanonical, 53
  - microcanonical entropy, 53
  - related to quantum, n51 53
- Decimation, Ising model, f12.9 270
- Decoupling time, after Big Bang, e7.15 159, e10.1 231
- Defect entanglement: glasses and biaxial nematics, 202
- $\delta$ -function, Dirac, n11 19, 24, e3.6 56
  - correlation for white noise, 219
  - derivative of step, n10 38
  - not a function, n4 6
  - three-dimensional, 219
- Demon, Maxwell’s
  - as biological ion pump, f5.6 83
  - entropic limits to, 83, e5.2 92
- Dendritic growth, f11.12 251, 250–1, e11.9 259
  - crystalline anisotropy, e11.9 261
  - linear stability analysis, e11.9 260
  - metals and alloys, 251
  - tips grow fastest; less salty, humid, hot, 250, f11.21 260
- Density matrix, 136–9
  - and constant microscopic entropy, e7.4 153
  - basis-independent, 136
  - canonical distribution
    - $\rho = e^{-\beta\mathcal{H}}/(\text{Tr } e^{-\beta\mathcal{H}})$ , 137
  - entropy  $S = -k_B \text{Tr}(\rho \log \rho)$ , 138
  - needed for time-dependent ensembles, 136
  - no ODLRO for Fermi and non-degenerate Bose, e9.8 212
  - ODLRO for superfluids and superconductors, 136
  - ODLRO for superfluids, Bose condensates, e9.8 212
  - photon polarization, e7.5 154
  - pure states, 137
  - reduced
    - analogous to correlation functions, e9.8 212
- Bose condensate, superfluid, e9.8 211
  - spin, time evolution, e7.6 154
  - sufficiency, 137
  - superfluid,  $\langle a^\dagger(r')a(r) \rangle$ , e9.8 212
  - time evolution, 138
    - as quantum Liouville’s theorem, 138
    - minus Heisenberg evolution, n9 138
  - time independent for any mixture of energy eigenstates, 139
- Density of states
  - independent of boundary conditions, large system, n30 147
  - sloppy notation,  $g(\omega)$  vs.  $g(\varepsilon)$ , n32 147
- Derivative
  - high-order, small when lengths are long, n9 196
  - variational, n41 122, 196, e9.4 206, n7 218, e10.8 239
- Derivative (stock), e2.12 32
  - Black–Scholes model, e2.12 32
  - pricing, e2.12 32
- Detailed balance, e8.12 182
  - defined, 170
  - defined without using equilibrium density, e8.5 176
  - from time-reversal invariance, 170
  - in nanojunctions, e10.5 237
  - Metropolis algorithm, e8.6 176
  - radiation from colored objects, e7.7 155
  - why black-body radiation is black, n34 148, e7.7 155
  - Wolff algorithm, e8.8 177
- Dew, and nucleation, 244
- Diatomic molecules
  - Earth’s atmosphere, n13 39
  - free energy, n31 119
  - rotations and vibrations, n27 44, n54 56
- Dielectric permittivity  $\epsilon(\omega)$ 
  - vs. dielectric constant, n16 222
  - vs. polarizability  $\alpha(\omega)$ , n16 222
- Differential forms
  - and thermodynamics, n23 116
  - inexact, exact, and closed, n23 116
  - mathematical meaning of  $dE$ , n56 58, n23 116
- Differentiation: cellular specialization, e8.11 180
- Diffraction experiments, f10.6 218
  - and Fourier transforms, 217, 299
  - complementary to real-space microscopy, 217
  - form factors, n6 217
  - measure correlation function, 217
  - precision, ties with theory, 218
- Diffusion
  - constant, sign explained, n14 20
  - photons in Sun, e2.2 26

- Diffusion equation, 19–25  
 and central limit theorem, 25  
 and Onsager's regression hypothesis, 220  
 as approach to equilibrium, 22  
 as case of general evolution law, e9.6 209  
 as continuum random walk, f1.1 2, 19–22, f2.6 24  
 Black–Scholes model for derivative pricing, e2.12 33  
 chemotaxis, 25  
 constant rain solution, n19 22  
 decay of initial fluctuation, f10.7 220  
 decay of initial state, f10.8 220  
 Einstein relation  $D/\gamma = k_B T$ , n20 22, 123  
 exponential atmosphere, 22  
 Fourier methods solve, 23  
 from free energy density, 123  
 Green's function, 23–5  
 ignores spontaneous fluctuations, 220  
 imaginary  $D$  gives Schrödinger's equation, n23 23  
 macroscopic law describing micro-correlations, 221  
 sinusoidal initial state 'squelched', e2.6 28, e2.7 29, e2.8 30  
 smears density sideways, 25  
 solving, 22–5  
 'squelches' short wavelengths, 23  
 thermal conductivity, n4 16, e2.8 30  
 frying pan, e2.9 30  
 with external force or drift, 21  
 Digital memory tape, f5.10 92  
 frugal, one atom per bit, e5.2 91  
 Dimension, fractal  
 capacity vs. information, e5.16 101  
 definition, n6 17  
 for random walk, f2.2 18  
 Dimerization reaction, e8.10 178  
 Dirac  $\delta$ -function, n11 19, 24, e3.6 56  
 correlation for white noise, 219  
 derivative of step, n10 38  
 not a function, n4 6  
 three-dimensional, 219  
 Disclination, e9.1 203  
 nematic, f9.14 200  
 clock arithmetic, 201  
 own antiparticle, 201  
 Dislocation, f9.11 198  
 Burger's vector, f11.15 254  
 classified by homotopy theory, f9.12 199  
 energy released, motion under stress, e11.5 254  
 entanglement not topological, 202  
 extra half-layer of atoms, 198  
 long-range interaction, e11.5 254  
 mediates bending  
 crystal, n15 200  
 crystals and superfluids in two dimensions, n22 254  
 mediates bending of crystal, e11.5 255  
 no plasticity in linear response, e11.5 255  
 nucleation under stress, e11.5 254  
 represented by 'tee', e11.5 254  
 Disorder and entropy, 81–5  
 Disordered system  
 phase transition, 280  
 replica vs. cluster models, n22 280  
 vs. glass, n20 280  
 Dispersion relation  
 definition, n40 152  
 massive Bose particles, e7.2 152  
 phonons, e10.9 240  
 photons, e7.2 153  
 relativistic particles, e7.2 153  
 Dissipation, 223–4  
 and fluctuations, theorem, 227–9  
 and ultrasonic attenuation, 223, e10.9 240  
 balanced by thermal noise, e10.7 238  
 friction and mechanics, 117, 227, e10.3 235, e10.7 238  
 imaginary part of susceptibility  $\chi''(\omega)$ , 223, e10.3 235  
 related to correlation, fluctuation-dissipation theorem  
 (classical)  $\chi''(\omega) = (\beta\omega/2)\tilde{C}(\omega)$ , 228  
 (quantum)  $\chi''(\mathbf{k}, \omega) = (1/2\hbar)(1 - e^{-\beta\hbar\omega})\tilde{C}(\mathbf{k}, \omega)$ , 229  
 related to real susceptibility by Kramers–Krönig, 229–31  
 resistance, 223  
 two-state spin, e10.4 236  
 vanishes as  $\omega \rightarrow 0$  for Goldstone modes, e10.9 240  
 Distinguishable particles  
 partition function, 145  
 vs. undistinguished particles, n24 145  
 Diversification, risk, and random walks, e2.11 32  
 DNA  
 configuration as random walk, e2.10 30  
 persistence length, e2.10 30  
 Doppler shift, and microwave background Planck spectrum, e7.15 159  
 Double well, e6.2 125  
 model for glass, 84  
 potential, f5.7 84  
 vs. convexity, f9.22 208, f11.2 242, e12.5 284  
 Droplet fluctuations, abrupt phase transition, n2 241  
 Drunkard's walk, 16–17, f2.1 17  
 Dynamical corrections to transition state theory, e6.11 130  
 Dynamical corrections to transition-state theory, n35 120  
 Dynamics  
 bifurcation theory, as phase transition, 279–80, e12.4 283, e12.9 288  
 chaotic, 279  
 butterfly effect, e5.9 96  
 earthquake fault, 271  
 ergodic, 65–9  
 glassy, n22 84, 280  
 Hamiltonian, 63  
 general, n4 64  
 implications from Liouville, 65  
 no attractors, 65  
 phase-space flow incompressible, 65  
 preserves symplectic form, n6 64  
 jamming, as theory of glass transition, 281  
 not determined from statistical mechanics, 220  
 Onsager's regression hypothesis, 220  
 quantum mechanics, 220  
 of maps, related to continuous, n50 97  
 one-dimensional magnet, e10.8 238  
 planetary, vs. ergodicity, e4.4 72  
 slow  
 arise from conspiracy, 196  
 arise in three ways, n37 121  
 Dyson, Freeman, life and heat death of Universe, 81, e5.1 91  
 Earthquake, 263  
 Burridge–Knopoff / Carlson–Langer model, f12.4 265  
 energy release vs. time, f12.3 265  
 models, self-organized critical, 271  
 Edge rounding transition, equilibrium crystal shape, f11.6 247  
 Efficiency  
 limit  
 data compression, n33 87, e5.14 100, e5.15 100  
 heat engine, 78  
 Maxwell's demon, 83, e5.2 92  
 none on electrical motors, 77  
 refrigerator, e5.6 95  
 molecular motors, e2.3 27  
 Eigenvector, left and right, for asymmetric matrix (Markov chain), 168, e10.5 236  
 Eight-fold way from group representation theory, 306  
 Einstein  
 $A$ ,  $B$  coefficients  
 and lasing, e12.6 285  
 stimulated and spontaneous emission, absorption, e7.8 155

- relation  $D/\gamma = k_B T$ , n20 **22**  
 from free energy density, 123  
 theory of relativity, vs. cosmic microwave background radiation, n30 **232**
- Elastic scattering, and equal-time correlation function, 217
- Electrical conductivity  
 diffusion equation, n4 **16**  
 related to AC polarizability  
 $\sigma = \lim_{\omega \rightarrow 0} \omega \alpha''(\omega)$ , 224
- Elementary excitation, 196–8  
 not at low frequency in superconductor, 197  
 orientational  
 none for crystal, 197  
 rotational wave in liquid crystal, f9.10 **197**  
 second sound (heat wave) in superfluid, 197  
 sound in crystal, f9.8 **196**  
 spin wave in magnet, f9.9 **197**
- Emergent  
 fractal scale invariance  
 Ising  $T_c$ , f12.1 **263**  
 percolation  $p_c$ , n4 **267**  
 random walk, 17  
 law, 15  
 field theory, particle physics, 265  
 fluid mechanics, quantum mechanics, 265  
 fundamental versus specific, n1 **15**  
 gravitation as an, n1 **15**  
 mathematical effectiveness, unreasonable, n1 **15**  
 properties, studied by  
 condensed-matter physics, 192  
 symmetry  
 rotation, translation invariance, n4 **267**  
 rotational, in random walks, e2.5 **28**  
 translational, rotational, Lorentz, in lattice quantum chromodynamics, 265
- Emission  
 of light from small hole, e7.7 **154**  
 spontaneous vs. stimulated, e7.9 **156**  
 Einstein coefficient, e7.8 **155**
- Endothermic reaction, definition, n32 **120**
- Energy  
 analogue, conserved in domain wall structure, e9.4 **206**  
 $dE = T dS - P dV + \mu dN$ , 116  
 eigenstates, many-body, peculiar, n10 **139**  
 extensive variable, 46  
 fluctuations  
 and specific heat, e3.8 **56**, 108, e8.2 **174**  
 Gaussian, n37 **46**, e3.7 **56**  
 kinetic energy measures specific heat, e3.8 **56**  
 tiny for large system, n37 **46**, e3.7 **56**, e3.8 **56**, 108  
 from canonical partition function, 107  
 no minimum cost for computation, e5.3 **93**  
 no minimum cost for measurement, e5.2 **91**  
 quantum harmonic oscillator  
 canonical, 139  
 vs. dirt in disordered system transition, 280  
 vs. entropy at thermal phase transition, 278  
 vs. zero-point fluctuations at quantum phase transition, 278
- Energy conservation, 77  
 and the Carnot cycle, 79
- Energy gap  
 as particle mass in field theory, n11 **140**, n11 **197**  
 black-body radiation, 148  
 Ising model, e8.2 **175**  
 quantum harmonic oscillator, 140  
 superconductor, 136
- Energy shell, 38  
 average  $\langle O \rangle_E$ , 38  
 $(1/\Omega) \int d\mathbb{P} d\mathbb{Q} O \delta(E - \mathcal{H})$ , 39  
 dawdling regions thicker, f3.1 **38**, 67  
 ideal gas, f3.2 **42**  
 stirred, but relative weights maintained, 65  
 volume  $\Omega(E)$ , 38  
 Gibbs factor  $1/N!$ , 52  
 grows rapidly with  $E$ , e3.7 **56**  
 $\int d\mathbb{P} d\mathbb{Q} \delta(E - \mathcal{H})$ , 39  
 not surface area, n23 **42**  
 so large that multiplying by constant is irrelevant, n47 **51**  
 volume  $\Omega(E)$ , divided by  $h^{3N}$ , 52  
 general argument, n42 **153**  
 Nernst's theorem, e7.3 **153**  
 quantum state counting, e7.3 **153**  
 semiclassical and path-integral arguments, n42 **153**
- Energy surface, as thin energy shell, n2 **63**
- Engineering exercises, e11.5 **254**, e11.7 **255**, e11.8 **258**
- Engines  
 electrical, 77  
 heat, 77–80  
 entropic limit to efficiency, 78  
 $P$ - $V$  diagram, e5.5 **94**  
 perpetual motion, f5.1 **78**  
 steam, 77
- Ensemble  
 canonical, *see* Canonical ensemble  
 comparing microcanonical, canonical, grand canonical for Bose, Fermi, Maxwell–Boltzmann, distinguishable, e7.1 **151**  
*en masse* solutions, 37  
 equilibrium, cannot determine dynamics, 220  
 grand canonical, *see* Grand canonical ensemble  
 microcanonical, *see* Microcanonical ensemble  
 multiple choices for, 115  
 transforming between different, with Legendre transformation, 115
- Ensemble average  
 denoted by angle brackets  $\langle \cdot \rangle$ , n2 **16**, 220  
 equal-time denoted  $\langle \cdot \rangle_{\text{eq}}$ , 220  
 evolving denoted by  $\langle \cdot \rangle_{\text{ev}}$ , 220  
 of evolution from fixed initial condition  $[\cdot]_{\rho_i}$ , 220
- Enthalpy  $H$   
 $dH = T dS + V dP + \mu dN$ , 116  
 $E + PV$ , 116
- Entropic force  
 ideal gas, 123  
 pollen, e6.13 **132**  
 rubber band, e5.12 **98**
- Entropy, 77–103  
 additive for uncorrelated systems, 90  
 always increases, n3 **77**  
 and chemical potential,  
 $\mu = -T(\partial S/\partial N)|_{E,V}$ , 47  
 and information dimension, e5.16 **101**  
 and pressure,  $P = T(\partial S/\partial V)|_{E,N}$ , 47  
 and telephone frequency range, e5.15 **100**  
 as disorder, 81–5  
 as ignorance, 85–90  
 as irreversibility, 77–81  
 as measure of knowledge about system, 86  
 black hole, e5.4 **94**  
 burning information, e5.2 **92**  
 card shuffling, e5.13 **99**  
 Carnot cycle, 78–80  
 change  
 and heat flow  $\Delta S = \int dQ/T$ , 84  
 and heat flow  $\Delta S = Q/T$ , 80  
 for conditional probabilities, 89  
 upon greater knowledge, 89  
 change upon forgetting a bit, e5.2 **92**  
 classical non-equilibrium  
 $S = -k_B \int \rho \log \rho$ , 86  
 communications theory, 82, 87, e5.15 **100**  
 connotations of the word, n1 **77**

- constant during adiabatic changes, 49, 51
- convex downward, n37 46, f5.9 88, e8.12 182
- counting, 82
- currency paid for energy bought from world, 46
- data compression, e5.14 100, e5.15 100
- decrease preceding rare fluctuation into ordered state, n10 81
- defines the future, 80
- definition, microcanonical  
 $S = k_B \log \Omega$ , 45
- density matrix, 86, 138
- discrete  $S = -k_B \sum p \log p$ , 86
- $dS = (1/T) dE + (P/T) dV - (\mu/T) dN$ , n40 47
- equivalence of thermodynamic and statistical, n6 80, 84
- extensive variable, 46, 90
- from canonical partition function, 108
- from Helmholtz free energy, 108
- Gibbs paradox, n16 83
- glasses, 83–5, e5.11 97  
 if configuration were known, 86
- hard sphere gas, e3.5 55
- heat death of Universe, 81, e5.1 91
- human desegregation, negligible, n13 82
- ideal gas  
 canonical, 111  
 crude, 51  
 microcanonical, 53
- ignorance function, 87, e5.17 102
- information  
 $S = -k_S \sum p \log p$ , 87–90
- information and work, 83, e5.2 91
- Jensen's inequality, n36 88
- $k_S$  instead of  $k_B$ , 87
- losing one's keys, 87
- lossless data compression, n33 87
- lossy data compression, n33 87
- maximized in equilibrium, n36 46
- maximum for equal probabilities, 88
- measure of uncertainty, n26 85
- measuring of states not chosen, 84
- messy rooms, 81
- microcanonical  
 almost extensive, n35 46  
 ideal gas, 53  
 ideal gas, crude, 51  
 microscopic, does not increase, 87, e5.7 95, e7.4 153  
 classical derivation, e5.7 95  
 quantum derivation, e7.4 153
- minus slope of Gibbs free energy with respect to  $T$ , 242
- mixing, 82  
 mixed diagram, f5.5 82  
 segregated diagram, f5.4 82
- mixing identical particles  
 avoided by Gibbs factor  $1/N!$ , 83  
 microscopic change, n15 83  
 no change, 83
- no minimum change during computation, e5.3 93
- non-decreasing, n3 77
- non-equilibrium, 86, e5.17 102
- not extensive for gravitational systems, n35 46
- not the only measure of disorder, n12 81
- not zero at  $T = 0$ , but density  $S/N$  is, n20 115, n41 153
- of photons and matter in Universe, e7.15 160
- osmotic pressure, n17 83
- partial information, 86
- per bit, 82, n32 87
- quantum  $S = -k_B \text{Tr}(\rho \log \rho)$ , 86, 138
- redundancy in English, e5.15 100
- reversible computation, e5.3 93
- roads not taken, 83, f5.8 85
- rubber band, e5.12 98
- scrambling an egg, 82
- Shannon, 87–90, e5.15 100  
 $S = -k_S \sum p \log p$ , 87
- surface in  $(S, E, V)$  space, f3.4 48
- the arrow of time, 80
- thermodynamic  
 and glasses, e5.11 97  
 definition  $\Delta S = Q/T$ , 80  
 three interpretations, 77  
 three key properties specify form, 87, e5.17 102
- time-reversal invariance, 80, 87, e5.7 95, e7.4 153
- unaffected by zero probability states, 88
- unchanged by reversible process, 80
- upper and lower bounds, measured non-equilibrium, e5.11 98
- vs. energy at thermal phase transition, 278
- written works of human history, compared to gas, n27 85
- zero set by quantum mechanics, 52, 115, e7.3 153
- Entropy, increase  
 (perversely) at some ordering transitions, n12 81  
 and CPT invariance, n8 80  
 and electromagnetic wave emission, n9 80  
 and Lyapunov exponents, e5.9 96  
 as emergent property, 90, e5.7 95  
 C. P. Snow and Shakespeare, n19 115  
 card shuffling, e5.13 99  
 cat map, e5.8 95  
 diffusion equation, e5.10 97
- during billiards or pool, 80  
 for antimatter beings, n8 80  
 Markov chains, e8.12 182
- Entropy, limits on, 90  
 computation, e5.3 93  
 data compression, 87, e5.14 100, e5.15 100  
 density, e5.4 94  
 heat engine efficiency, 78  
 Maxwell's demon, e5.2 92  
 measurement, e5.2 91  
 memory, e5.4 94  
 refrigerator efficiency, e5.6 95  
 thought, e5.1 91
- Enzyme, definition, n29 118
- $\epsilon$ -expansion, renormalization-group, 172, 269
- Equal-area construction, Maxwell, f11.3 244, 243–4  
 makes sense only in mean field, n11 244  
 van der Waals, e11.1 251
- Equal-time correlation function, f10.4 217, f10.5 218, 218–20  
 one-dimensional magnet, e10.8 239
- Equation of state, 52  
 ideal gas, 52  
 rarely closed form, n48 52
- Equilibration  
 and diffusion equation, 22  
 as regression to the mean, 65  
 Hamiltonian and dissipative different mechanisms, 65, e4.3 71  
 regression to the mean, 39  
 time, in molecular dynamics, e4.1 69
- Equilibrium, *see also* Chemical equilibrium  
 average over phase space, 37  
 connotations of the word, n1 77  
 defined, 37  
 falling out of, 85  
 fluctuates for small system, n3 37  
 independent of external world, except for  $T, P, \mu$ , 46, e3.9 57  
 not fluctuations, e3.9 57  
 independent of initial conditions, 37  
 no dynamics  
 needs Onsager's regression hypothesis, 220  
 needs quantum mechanics, 220  
 testing, with detailed balance, e10.5 237  
 Universe, nearly perfect after Big Bang, e7.15 159, e10.1 231
- Equilibrium crystal shape, f11.6 247, f11.10 249
- Equipartition theorem  
 and diffusion equation, n20 22  
 and ultraviolet catastrophe, 147  
 black-body radiation, wrong for, 148

- classical harmonic oscillator, 111  
 for classical momentum, 44  
 quantum harmonic oscillator at high  $T$ , 140  
 yielding magnetization fluctuations, e10.8 239
- Ergodic, 65–9  
 component, 66  
 definition  
   dynamical vs. Markov, 170  
   no components which do not intermingle, 66  
   physics vs. mathematics, n20 169  
   trajectory passes near every point, 66  
 geodesics on negatively curved surface, 67  
 hard spheres, 67  
 hypothesis, 65  
 Markov chain, 169  
 mathematicians allow transient states, n20 169  
 theorem, *see* Ergodic hypothesis  
 thoroughly stirred, 65  
 time average equals microcanonical average, 66  
 usually not possible to prove  
   not a concern, 69  
 vs. KAM tori, 68  
 vs. mixing, n9 66  
 Wolff algorithm, e8.8 177
- Ergodicity  
 breakdown  
   at glass transition, 69  
   with anharmonic localized modes, 68  
 breakdown at broken symmetries, 68  
 broken at glass transition, 280  
 Feigenbaum map,  $\mu = 1$ , e4.3 71  
 not for planetary motion, e4.4 74  
 usually not possible to prove for  
   microscopic dynamics, 67  
 vs. Fermi, Pasta, Ulam, and KdV, 68  
 vs. KAM tori, f4.3 66  
 why is Earth not interstellar?, e4.4 73
- Ericksen–Leslie liquid crystal free energies, n22 206
- Euler method, solving PDE not ODE, e3.12 59
- Euler relation  $E = TS - PV + \mu N$ , e6.8 128  
 implies  $\mu$  equal at phase coexistence, 242
- Evaporation  
 does not change momentum  
   distribution, e6.1 125
- Exclusive OR gate, and irreversible computation, e5.3 93
- Exercises  
 difficulty rating scheme, vi
- Exercises, by difficulty  
 ① inspection, e3.1 54, e3.2 54, e6.2 125, e8.1 174, e8.6 176, e12.1 282, eA.1 307  
 ② basic, e1.1 4, e1.2 5, e1.4 7, e2.1 25, e2.2 26, e2.3 26, e2.4 27, e2.6 28, e2.7 29, e2.8 30, e2.9 30, e2.11 31, e2.12 32, e3.3 54, e3.4 54, e3.5 55, e3.8 56, e3.9 57, e4.1 69, e4.2 70, e5.1 91, e5.5 94, e5.6 95, e5.12 98, e5.14 100, e6.1 124, e6.4 126, e6.5 127, e6.8 128, e6.9 129, e6.11 129, e7.7 154, e7.10 157, e7.13 158, e8.3 175, e8.4 175, e8.5 176, e12.2 282, eA.2 307, eA.3 307, eA.4 308, eA.5 309, eA.6 309, eA.8 311, eA.9 311  
 ③ challenging, e1.3 6, e1.5 7, e1.6 8, e1.8 12, e2.5 28, e2.10 30, e3.6 55, e3.7 56, e3.10 58, e3.11 58, e4.4 72, e5.2 91, e5.3 93, e5.4 93, e5.7 95, e5.8 95, e5.9 96, e5.10 97, e5.11 97, e5.13 99, e5.15 100, e5.17 102, e6.3 125, e6.6 128, e6.7 128, e6.10 129, e6.12 131, e6.13 132, e6.14 133, e7.1 151, e7.2 152, e7.3 153, e7.4 153, e7.5 154, e7.6 154, e7.8 155, e7.9 156, e7.11 157, e7.12 157, e7.15 159, e7.16 161, e8.2 174, e8.8 177, e8.12 182, e9.1 203, e9.2 204, e9.3 205, e9.4 206, e9.5 206, e9.6 209, e9.7 210, e10.1 231, e10.2 233, e10.3 235, e10.4 236, e10.5 236, e10.6 237, e10.7 238, e10.8 238, e10.9 239, e11.1 251, e11.2 252, e11.3 252, e11.4 253, e11.5 254, e11.6 255, e11.7 255, e11.8 258, e11.9 259, e12.3 282, e12.4 283, e12.5 284, e12.6 284, e12.7 285, e12.8 286, e12.13 296, eA.7 310, eA.10 311  
 ④ project, e1.7 9, e2.13 33, e3.12 58, e4.3 70, e5.16 101, e7.14 158, e8.7 176, e8.9 177, e8.10 178, e8.11 179, e8.13 182, e8.14 185, e8.15 186, e12.9 288, e12.10 291, e12.11 291, e12.12 293  
 ⑤ advanced, e9.8 211
- Exercises, by subject  
 Astrophysics, e2.2 26, e4.4 72, e5.1 91, e5.4 93, e7.15 159, e7.16 161, e10.1 231  
 Atomic physics, e7.9 156, e7.13 158, e7.14 158  
 Biology, e2.3 26, e6.4 126, e6.12 131, e8.10 178, e8.11 179  
 Chemistry, e6.8 128, e6.9 129, e6.10 129, e6.11 129, e11.1 251, e11.2 252, e11.3 252  
 Complexity, e1.7 9, e2.13 33, e4.3 70, e5.9 96, e5.14 100, e5.16 101, e8.13 182, e8.14 185, e12.9 288, e12.12 293, e12.13 296  
 Computation, e1.7 9, e1.8 12, e2.4 27, e2.5 28, e2.10 30, e2.11 31, e2.13 33, e3.4 54, e3.12 58, e4.1 69, e6.1 124, e6.12 131, e8.1 174, e8.2 174, e8.6 176, e8.7 176, e8.8 177, e8.9 177, e8.10 178, e8.11 179, e8.13 182, e8.14 185, e8.15 186, e10.2 233, eA.2 307, eA.4 308, eA.7 310, eA.8 311  
 Computer science, e1.8 12, e5.2 91, e5.3 93, e5.14 100, e5.15 100, e8.15 186  
 Condensed matter, e2.10 30, e5.11 97, e5.12 98, e7.10 157, e7.11 157, e7.12 157, e9.1 203, e9.2 204, e9.3 205, e9.4 206, e9.5 206, e9.7 210, e9.8 211, e10.4 236, e10.5 236, e10.6 237, e10.8 238, e11.9 259, e12.2 282, e12.3 282, e12.5 284, e12.8 286  
 Engineering, e11.5 254, e11.7 255, e11.8 258  
 Finance, e2.11 31, e2.12 32  
 Mathematics, e1.3 6, e1.4 7, e1.5 7, e1.6 8, e1.8 12, e3.10 58, e3.11 58, e4.2 70, e4.3 70, e4.4 72, e5.7 95, e5.8 95, e5.9 96, e5.13 99, e5.14 100, e5.16 101, e5.17 102, e7.4 153, e7.8 155, e8.3 175, e8.4 175, e8.6 176, e8.8 177, e8.12 182, e8.15 186, e9.1 203, e9.2 204, e9.3 205, e11.7 255, e11.8 258, e12.4 283, e12.6 284, e12.9 288, e12.10 291, e12.11 291, eA.10 311  
 Optics, e7.8 155, e7.9 156, e12.6 284  
 Quantum, e1.1 4, e1.6 8, e7.1 151, e7.2 152, e7.3 153, e7.4 153, e7.5 154, e7.6 154, e7.7 154, e7.8 155, e7.9 156, e7.10 157, e7.11 157, e7.12 157, e7.13 158, e7.14 158, e7.16 161, e9.7 210, e9.8 211, e12.6 284  
 Statistics, e6.14 133  
 Thermodynamics, e3.10 58, e3.11 58, e5.5 94, e5.6 95, e6.5 127, e6.6 128, e6.7 128, e6.8 128, e6.9 129, e6.10 129  
 Exothermic reaction, definition, n32 120



- Extensive variable, definition, 46
- Extensivity  
 and Euler relation, e6.8 128  
 and Gibbs–Duhem relation, e6.9 129  
 and large numbers, e3.2 54  
 Helmholtz free energy, 109  
 of entropy, 90
- Eye blink  
 atoms collide a million, million times during, 196  
 entropy larger than human desegregation, n13 82
- Faceting, on equilibrium crystal shape, f11.6 247, f11.10 249
- Fast Fourier transform (FFT)  
 aliasing, eA.7 310  
 centered plots, 301, n6 301  
 counting modes, eA.7 310  
 definition, 301  
 windowing, eA.7 310
- Feigenbaum map  
 boundaries, e4.3 72  
 fractal dimension at  $\mu_c$ , e5.16 101  
 invariant measure, e4.3 70  
 Lyapunov exponents, e5.9 96  
 period-doubling cascade, renormalization group, e12.9 288
- Feigenbaum numbers,  $\alpha$ ,  $\delta$ , e12.9 290
- Fermi energy, 150
- Fermi gas, free, 150–1  
 fixed point of renormalization group, e12.8 287  
 not accurate for metals, 151
- Fermi liquid theory, n23 144  
 perturbed from free Fermi gas, 172  
 renormalization group, n23 144, e12.8 286  
 flow diagram, f12.20 287
- Fermi sphere, f7.7 147, n38 150
- Fermi statistics, 140–1  
 antisymmetric wavefunctions, 140  
 exclusive, 145  
 Maxwell–Boltzmann at low occupancy, high  $T$ , 143
- Fermi surface, 151  
 aluminum, f7.11 151  
 lithium, f7.10 150
- Fermi, Pasta, Ulam, and KdV ergodicity breakdown, 68
- Fermi–Dirac distribution  
 occupation of non-interacting states, f7.4 142, 143, f7.5 143
- Fermion  
 electron, proton, neutron, neutrino, quark, n14 140  
 free, 150–1  
 grand partition function, 143  
 half-integer spin, n14 140
- non-interacting, 143  
 amazing utility, 144  
 and Fermi liquid theory, n23 144  
 occupation, 143
- Ferromagnet, 164
- Feynman diagram  
 antiparticles, as backward in time, f7.3 141  
 low-temperature expansion, cluster, f8.7 172
- Feynman diagrams  
 sum not convergent, e1.5 8
- FFT, *see* Fast Fourier transform
- Fidelity, of numerical solution to Hamiltonian system, e3.12 59
- Finance exercises, e2.11 31, e2.12 32
- Finite-size scaling, 277, e12.12 294
- Finite-size scaling function, 277
- First homotopy group, *see* Homotopy group, first
- First law of thermodynamics:  
 conservation of energy, 77, 114
- First-order phase transitions, *see also* Abrupt phase transitions  
 avoid using term, n7 243  
 jumps in first derivatives of free energies, 243
- Fixed point  
 renormalization-group, 269  
 stability, n24 71, n33 289  
 stable, antithesis of Liouville, e4.3 71
- Fluctuation-dissipation theorem, 227–9  
 classical  
 $\chi''(\omega) = (\beta\omega/2)\tilde{C}(\omega)$ , 228  
 dissipated power proportional to fluctuation correlations, 229  
 general, n24 227  
 harmonic oscillator, e10.3 235  
 ideal gas, 228  
 Ising model, e10.6 237  
 quantum  
 $\chi''(\mathbf{k}, \omega) = (1/2\hbar)(1 - e^{-\beta\hbar\omega})\tilde{C}(\mathbf{k}, \omega)$ , 229  
 sound waves, e10.9 240  
 speculative applications out of equilibrium, 229  
 time,  $\chi(\mathbf{x}, t) = -\beta\partial C(\mathbf{x}, t)/\partial t$  ( $t > 0$ ), 228
- Fluctuation-response relation  
 easy to perturb, big fluctuations, 225  
 general,  $\tilde{\chi}_0(\mathbf{k}) = \beta\tilde{C}(\mathbf{k}, 0)$ , 225  
 general, uniform, 226  
 specific heat and energy fluctuations, e3.8 56, 108, e8.2 174  
 susceptibility and magnetization, e8.2 174
- Fluctuations  
 average, not measured as mean absolute size (non-analytic), n3 16  
 density, probability from free energy density, 219, 220  
 droplet, near abrupt phase transition, n2 241  
 energy, and specific heat, e3.8 56, 108, e8.2 174  
 exam score, e2.1 25  
 friction and mechanics, 117, 227, e10.3 235, e10.7 238  
 ignored by Landau theory, e9.5 209
- Ising model  
 and susceptibility, e8.2 174  
 self-similar, at  $T_c$ , f1.2 3, f9.23 209, 263
- microwave background radiation, f10.13 232  
 correlation function, f10.14 232  
 number, 40, e3.9 57  
 Gaussian, e3.9 57  
 grand canonical ensemble, 113  
 molecules in cells, ignored by reaction rate theory, e8.10 178, e8.11 181  
 probability from free energy density, 220
- rare  
 critical droplet theory and instantons, n14 246  
 into ordered state, decreasing entropy, n10 81  
 related to susceptibility, fluctuation-response relation, 225  
 shot noise, e8.10 179, e8.11 181  
 telegraph noise, e8.11 181  
 thermal wiggling, 215  
 tiny for large system, 41, n37 46, 226  
 energy, n37 46, e3.7 56, e3.8 56, 108, e6.3 126  
 number, 41  
 zero-point, vs. energy at quantum transition, 278
- Fog, and nucleation, 244
- Force balancing and minimization of free energy, 117
- Forgetting, entropy change per bit, e5.2 92
- Form factors, and X-ray diffraction, n6 217
- Four-color theorem, n15 12
- Fourier, 299–312  
 aliasing in FFT, eA.7 310  
 and momentum space in quantum mechanics, n2 299  
 as group representation theory, 306  
 as superpositions of plane waves, 23

- change of basis in function space, 303–5
- conventions, 299–302
- counting modes in FFT, eA.7 310
- derivative multiplies by  $-i\omega$ , 302
- diffraction experiments measure, 217, 299
- diffusion equation, e2.6 28, e2.7 29, 302
- discrete but infinite (Brillouin zone), n8 301
- ear as effective transform, 299
- caveats, n1 299
- fast transform (FFT)
- centered plots, 301, n6 301
- definition, 301
- wonderfully effective, 22
- Gibbs phenomenon, eA.10 311
- inconsistent convention, space  $-ik$  and time  $i\omega$ , 300
- wave propagation rationale, n3 300
- integral divides by  $-i\omega$ , 302
- inverse transform, 300
- makes calculus, correlations,
- convolutions into algebra, 299, 302–3
- many conventions different fields, 301
- normalization, rationale for series and transform, n4 300
- of convolution is product, n12 221, 222, 224, e12.11 292, 303
- of correlation function is power spectrum, 217, n22 225, e10.1 233, 303
- of power spectrum is correlation function, 303
- of product is convolution, 303
- of real  $y$ ,  $\tilde{y}(\omega) = \tilde{y}^*(-\omega)$ , 301
- series and inverse series, definition, 299
- series as coefficients of expansion in plane-wave basis, 304
- series related to FFT, eA.6 309
- series related to transform, fA.1 300
- solves diffusion equation, 23
- solves linear translation-invariant systems, 23
- solves translation-invariant linear systems, 299, 305–6
- tilde  $\tilde{A}(\mathbf{k}, \omega)$  vs. hat  $\hat{A}(\mathbf{k}, t)$ , n14 222
- transform, 300
- of Gaussian, bogus derivation, n25 24, n24 308
- of Gaussian, is Gaussian, n24 24, eA.4 308
- translating function multiplies by plane wave, eA.4 309
- uncertainty principle, eA.4 308
- white noise, eA.8 311
- why many versions, 301
- widening function narrows transform, eA.4 308
- windowing, eA.7 310
- Fourth homotopy group, classifies instantons, n16 200
- Fractal
- avalanche time series, f8.18 184
- Ising model  $T_c$ , 263, e12.1 282
- multifractal dimensions, e5.16 102
- non-integer Hausdorff dimension, n1 263
- random walk, 17
- strange, rugged sets, n1 263
- structure emerging at critical point, 272
- Fractal dimension
- and coarse-graining, n10 274
- capacity vs. information, e5.16 101
- definition, n6 17
- is critical exponent  $1/\sigma\nu$ , 274
- random walk, f2.2 18
- Frank liquid crystal free energies, n22 206
- Free body diagrams and minimization of free energy, 117
- Free energy, 105–34
- analogous to energy in Boltzmann weight, 109
- as thermodynamic potential, n39 47
- binary alloy, absorbing position fluctuations, n9 165
- complex for metastable state, n9 243
- convex, vs. Landau theory, n32 208
- decrease, Markov chains, e8.12 182
- for molecular motor on DNA, f2.8 26
- from coarse-graining, 105, 121–3
- ignoring external world, 105–13
- ignoring internal degrees of freedom, 105, 117–21
- minimum not attained in martensites, e11.8 258
- surface terms and total divergences, e9.3 205
- why called free?, 109
- Free energy density
- for order parameter fields, 105, 121–3
- gradient terms, 123
- ideal gas, 121–3
- one-dimensional crystal, 196
- paper folding, e11.7 256
- Free particle in box, 146–7
- eigenstates, f7.6 146
- Friction
- and fluctuations, 117, 227, e10.3 235, e10.7 238
- and waste heat, 78
- damped wave equation, e9.6 210
- Galilean invariance and Kelvin damping, e9.6 210, e10.9 240
- not in Carnot cycle, 78
- viscous, from memoryless heat bath, e10.7 238
- Frustration, 280
- and curvature in glassy systems, f12.18 281
- spin glasses, f12.17 280
- Frying pan
- thermal diffusion in handle, e2.9 30
- Functional, as in free energy density, definition, n38 121
- Future, defined by entropy increase, 80
- $g(\omega)$  and  $g(\varepsilon)$ , sloppy notation for density of states, n32 147
- Galilean invariance, n50 240
- and Kelvin damping, e9.6 210, e10.9 240
- broken by Big Bang, n30 232
- Gauge invariance
- $a \rightarrow ae^{-i\zeta}$ , e9.8 213
- broken in superfluids and superconductors, e9.8 213
- electromagnetism, e9.8 213
- leads to number conservation, e9.8 213
- reparameterization invariance, n35 259
- Gaussian
- also known as normal distribution, n24 24, eA.4 308
- Fourier transform
- bogus derivation, n25 24, n24 308
- is Gaussian, n24 24, eA.4 308
- Green's function for diffusion equation, 24
- probability distribution, e1.2 5
- renormalization-group fixed point for sums, e12.11 291
- Generic scale invariance, 271, f12.10 271
- random walk, 271
- Gibbs ensemble, f6.4 116
- Gibbs factor, n50 52
- quantum Maxwell–Boltzmann statistics, 145
- Gibbs free energy  $G$
- and Maxwell construction, 243
- avoids phase coexistence, 242
- crossing determines abrupt phase transition, f11.2 242
- $dG = -SdT + VdP + \mu dN$ , 116, 242
- $E - TS + PV$ , 116, e6.4 127, 242
- equals  $\mu N$ , 242
- minimizing maximizes entropy, n6 242
- per unit area gives surface tension, 245, e11.3 253
- slope with respect to  $T$  gives entropy, 242
- Gibbs paradox
- $N!$  correction to avoid, 52
- and entropy of mixing, n16 83
- Gibbs phenomenon, Fourier series, eA.10 311

- Gibbs–Duhem relation  
 $0 = S dT - V dP + N d\mu$ ,  
 e6.9 129
- Gillespie algorithm, for stochastic  
 chemical reactions, e8.10 179,  
 e8.11 180
- Ginsburg–Landau theory, n23 206
- Glass  
 boiled sweets, n20 84  
 broken ergodicity, 69, 280  
 definition, 84  
 fall from equilibrium, 280  
 hard candy, 84  
 heat leak from internal relaxation,  
 e5.11 97  
 ideal, 281  
 long-range order in time, 280  
 low-temperature behavior, n22 84  
 metallic, 84  
 defect entanglement theory, 202  
 frustrated, f12.18 281  
 not in equilibrium, e5.11 97  
 number of microstates, 84, e5.11 98  
 residual entropy, 83–5, e5.11 98  
 magnitude, 84  
 specific heat on heating and cooling,  
 f5.18 98  
 spin, and frustration, f12.17 280  
 vs. disordered system, n20 280  
 window, 84
- Glass transition, n22 84, 280–1  
 as fall from equilibrium, 280  
 competing theories, 281  
 cross-over, 281  
 diverging viscosity, 280  
 jamming, 281  
 slow relaxation from diverging  
 barriers, 250
- Godot, waiting for, as Markov chain,  
 e8.3 175
- Goldstone mode, 196–8, e10.9 239  
 as origin of slow processes, n37 121  
 dissipation vanishes as  $\omega \rightarrow 0$ ,  
 e10.9 240  
 not for orientations in crystals, 197  
 dislocations mediate rotations,  
 n15 200  
 not in superconductors, 197  
 second sound (heat wave) in  
 superfluid, 197  
 sound waves, spin waves, heat waves,  
 197
- Good irrational, n30 74
- Googol and googolplex, e3.2 54
- Gradient expansion  
 high-order terms small when lengths  
 are long, n9 196  
 in diffusion equation, and square  
 symmetry, n32 28
- Landau theory, e9.5 207
- wave equation, e9.6 209
- Grand canonical ensemble, f6.3 112,  
 112–13  
 and number fluctuations, 113  
 avoids phase coexistence, n5 242  
 Boltzmann distribution, 112  
 chemical potential, 112  
 comparing Bose, Fermi,  
 Maxwell–Boltzmann,  
 distinguishable, e7.1 152  
 different from superfluid number  
 indeterminacy, n38 212  
 grand free energy  $\Phi$ , 112  
 grand partition function  $\Xi$ , 112  
 Lagrange multiplier, e6.6 128  
 non-interacting bosons, 142–3  
 non-interacting fermions, 143  
 non-interacting undistinguished  
 particles, 146  
 quantum non-interacting systems  
 convenient, 142  
 solves each eigenstate separately,  
 142
- Grand free energy  $\Phi$ , 112  
 $-k_B T \log(\Xi)$ , 112  
 $d\Phi = -S dT - P dV - N d\mu$ , 116  
 $E - TS - \mu N$ , 112
- Grand partition function  $\Xi$ , 112
- Graph colorability, e1.8 12
- Gravitation, as emergent law, n1 15
- Green’s function, 23–5  
 applied to diffusion, e2.6 28, e2.7 29  
 diffusion equation, 24  
 and central limit theorem, 25  
 in quantum field theory vs. linear  
 PDEs, n21 22  
 one-dimensional magnet, e10.8 239
- Group representation theory  
 and Landau theory, n25 207  
 from Fourier analysis, 306  
 spherical harmonics, 8-fold way, mass  
 and spin, 306
- Gutenberg–Richter law, earthquake  
 sizes, f12.3 265
- Explanation still controversial, n14 274  
 power law, 274
- Haber–Bosch process, ammonia  
 synthesis, n29 118
- Hairpin fold in RNA, f6.12 127
- Hamilton’s equations, 63
- Hamiltonian  
 binary alloy, and Ising, 165  
 general, for hinges and rigid bodies, 64  
 Ising model, 164  
 non-interacting particles, 141  
 of normal modes, uncoupled  
 oscillators, n11 111  
 random-field Ising model, e8.13 182  
 spin, e7.6 154
- standard, n11 39, 63  
 time dependent,  
 $d\mathcal{H}(V(t))/dt = \partial\mathcal{H}/\partial V dV/dt$ ,  
 50  
 uncoupled, and canonical ensemble,  
 109
- Hamiltonian system  
 all states created equal, 65  
 and area-preserving maps, n47 95  
 chaotic, e5.9 97  
 different from dissipative, 64  
 entropy non-increasing  
 classical, e5.7 95  
 quantum, e7.4 153  
 fidelity of numerical solution to,  
 e3.12 59  
 higher-order symplectic algorithms  
 less stable, e3.12 60  
 KAM theorem, 68  
 Liouville’s theorem, 63, 64  
 many invariants, 64  
 microcanonical ensemble time  
 independent, 65  
 no attractors, 65  
 phase-space flow incompressible, 65  
 symplectic algorithm, e3.12 59  
 symplectic form, n61 59, n6 64  
 Verlet methods faithful, n61 59
- Hard sphere gas, e3.5 55, f3.5 55  
 and van der Waals, e11.1 252  
 entropy, e3.5 55  
 pressure, e3.5 55
- Hard square gas, e6.13 132, f6.18 132
- Harmonic oscillator  
 canonical partition function  
 classical, 111  
 quantum, 139  
 eigenstates, f7.1 139  
 energy gap for  $k_B T \ll \hbar\omega$ , 140  
 excitations are bosons, e7.2 152  
 internal energy canonical  
 classical, 111  
 specific heat classical for  $k_B T \gg \hbar\omega$ ,  
 140  
 uncoupled family describing small  
 oscillations, n11 111
- Hausdorff dimension, fractal, e5.16 101,  
 n1 263
- Hawking and black-hole  
 thermodynamics, e5.4 94
- Heat and particle exchange, grand  
 canonical ensemble figure,  
 f6.3 112
- Heat bath, 105  
 all equivalent, apart from  $T$ ,  $P$ ,  $\mu$ , 46,  
 e3.9 57  
 as rest of world, 46  
 fluctuations not equivalent, e3.9 57  
 source and sink for heat, fixes  $T$ , 46
- Heat death of Universe, 81

- life and thought during, 81, e5.1 91
- Heat engines, 77–80  
and life at heat death of Universe, e5.1 91  
entropic limit to efficiency, 78  
piston diagram, f5.2 78  
 $P$ - $V$  diagram, e5.5 94, f5.15 94  
refrigerator in reverse, 78
- Heat exchange, canonical ensemble  
figure, f6.1 106
- Heat flow  
determined by temperature difference, 44  
equalizes probability of states of total system, 44
- Heat flow and entropy change, 80
- Heat wave, superfluid (rather cold), 197
- Heat, waste, 77, 78
- Heat-bath Monte Carlo, 166  
as Ising model, 167  
implementation, e8.7 176  
thermalizes one site at a time, 167
- Heaviside step function  $\Theta(x)$ , n10 38, n46 237, n28 311
- Heavy tails  
computer time for NP-complete problems, e8.15 188  
critical droplet theory and instantons, n14 246  
probability distribution, e8.15 188  
stock price fluctuations, e2.11 31
- Hedgehog defect, f9.13 199  
free energy, e9.3 205  
surface free energy  
and bulk total divergence terms, e9.3 205  
dominates bulk, e9.3 205  
wrapping number, 200
- Heisenberg model, n7 164  
order parameter, n4 193
- Heisenberg uncertainty  
and Fourier transform, eA.4 308  
vs. phase space, 135
- Helmholtz and heat death of Universe, 81
- Helmholtz free energy  $A$   
additive for uncoupled systems, 109  
 $dA = -S dT - P dV + \mu dN$ , 116  
 $E - TS$ , 108, 115  
extensivity, 109  
 $-k_B T \log Z$ , 108
- Hemoglobin, and cooperative oxygen binding, e6.12 132
- Higgs mechanism  
no Goldstone mode in superconductor, 197
- High-temperature expansion, 172  
Ising model, e8.2 175
- Hill equation, for cooperative chemical reactions, e6.12 131, e8.11 181
- Homotopy group  
counts circumnavigations  
through/around order parameter space, 200  
dislocation lines, commutative, 202  
equivalence class of paths, 201  
first, classifies line defects, 200  
fourth, classifies instantons, n16 200  
group inverse, 201  
group product as coalescence of defects, f9.15 201  
integral formula, e9.2 204  
nematic,  $\Pi_1(\mathbb{R}P^2) = \mathbb{Z}_2$ , 201  
non-commutative, and defect entanglement, f9.17 202, 201–3  
only two examples, 202  
paths on order parameter space, 199  
second  
classifies point defects, 200  
magnet,  $\Pi_2(S^2) = \mathbb{Z}$ , 200  
spheres onto order parameter space, 200  
superfluid, superconductor,  $\Pi_1(S^2) = \mathbb{Z}$ , e9.7 211  
third, classifies textures, skyrmions, n16 200  
2D crystal,  $\Pi_1(T^2) = \mathbb{Z} \times \mathbb{Z}$ , 199  
why a group?, 201  
zeroth, classifies walls, n16 200
- Homotopy theory, 198–203  
and path integrals, n16 200, n20 205  
escape into third dimension, e9.1 204  
fashionable in early 1980s, 198  
order parameter space path through holes, f9.12 199  
real-space loop around defect, f9.12 199  
systematic theory of defects, 198
- Hopf bifurcation, e12.4 284
- $H$ - $T$  phase diagram, Ising model / magnet, f8.5 166, e8.1 174
- Humans  
large and slow, e9.6 209  
slow, compared to atoms, 196
- Hysteresis and avalanches, e8.13 182, e8.14 185, e12.13 296  
avalanche figure, f12.5 266  
avalanche time series, f8.18 184  
Barkhausen noise, e8.13 182  
bits algorithm, e8.14 186  
scale invariance at  $R_c$ , f12.11 273  
sorted-list algorithm, e8.14 185  
subloops, f8.15 183
- Icosahedron, frustrated, and metallic glasses, f12.18 281
- Ideal gas  
and Euler relation, e6.8 128  
canonical partition function, 110
- configurations  
all equally likely, 39  
distinguishable density  $\rho = 1/V^N$ , 40
- correlation function  
equal-time, 218–20  
time dependent, 220–2
- entropy  
canonical, 111  
crude, 51  
microcanonical, 53
- equation of state, 52
- equilibration, limit of weak interactions and long times, n14 39
- free energy density functional, 121–3, 218  
linearized, 218
- Helmholtz free energy, 110
- internal energy, canonical, 110
- Maxwell relations, e3.11 58
- microcanonical ensemble, 39–44
- momentum distribution  
canonical, 111  
microcanonical, 42–4
- number fluctuations, 40  
tiny, 41
- pressure, 52
- temperature, 52
- time–time correlation function, Gaussian, 221  
uncorrelated at equal times, 219
- Identical particles, utterly the same, 52  
antiparticles as backward in time, f7.3 141  
vs. undistinguished particles, 52
- Ignorance  
and entropy, 85–90  
function, deriving Shannon entropy from, 87, e5.17 102
- Inclusive OR,  $\vee$ , n17 13
- Incompressible flow, f4.2 65
- Indistinguishable particles  
Gibbs factor  $1/N!$  for phase-space volume, 52  
non-interacting, 144–6  
vs. undistinguished particles, 52
- Inelastic scattering, and time-dependent correlation function, 217
- Inflation, and isotropy of the microwave background radiation, e10.1 232
- Information  
burning to do work, 83, e5.2 92  
dimension, fractal, and entropy, e5.16 102  
disposing of in black hole, e5.4 94  
limit to density, e5.4 94
- Information entropy, 87–90  
 $S = -k_S \sum p \log p$ , 87

- Instability of numerical solution to dynamical system, e3.12 60
- Instantons  
 calculates rare fluctuations, in tail, n14 246  
 classified by fourth homotopy group, n16 200  
 quantum analogue of critical droplet theory, n14 246
- Integral formula, Cauchy's, 230
- Integrate out degrees of freedom, *see* Partial trace
- Intensive variable  
 chemical potential, e6.9 129  
 definition, 46  
 $T$ ,  $P$ ,  $N$  not independent, e6.9 129
- Interfacial free energy  
 Landau theory, e9.4 206  
 rough calculation, e9.4 206, e11.3 253  
 van der Waals, e11.3 252
- Invariant measure  
 as ensemble for time averages, e4.3 72  
 logistic map, e4.3 70
- Inverse Fourier transform, series, and FFT, *see* Fourier
- Inversion symmetry, f9.25 210
- Ion pump as Maxwell's demon, f5.6 83
- Irrational  
 good, n30 74  
 most irrational number,  $(1 + \sqrt{5})/2$ , n30 74
- Irrelevant perturbation, renormalization group, e12.8 287  
 self-avoidance for random walks in  $d > 4$ , n9 19
- Irreversibility  
 and entropy, 77–81  
 hot and cold to warm, 78
- Ising model, 163–7, e8.1 174  
 antiferromagnetic, 164  
 as binary alloy, f8.3 165  
 at  $T_c$ , f1.2.3, f9.23 209, 263, f12.1 263  
 binary alloy, 165  
   atomic relaxation, 165  
    $\beta$ -brass, 165  
   Hamiltonian, 165  
   thermal position fluctuations, n9 165  
 coarse-graining at  $T_c$ , f12.9 270  
 coarsening, 216, f10.1 216, f11.7 247, e11.6 255  
   scaling, e12.3 282  
 critical droplet, e11.4 253  
 critical point fluctuations, 216, f10.3 217  
 Curie's law, e8.2 175  
 energy gap, e8.2 175  
 explicit mapping to binary alloy Hamiltonian, n8 165  
 extensively studied, 164  
 ferromagnetic, 164  
 fluctuation-dissipation theorem, e10.6 237  
 fluctuation-response relation, e8.2 174  
 frustrated next-neighbor, facets, log coarsening, 249, f11.10 249  
 Hamiltonian, 164  
 high-temperature expansion, e8.2 175  
 Ising solution in one dimension, 166  
 Landau theory, e9.5 206  
   domain wall energy, e9.4 206  
 lattice gas, 166  
 less realistic than Heisenberg model, n7 164  
 liquid–gas transition, 166  
   exact at critical point, 166, 266  
   not quantitative away from critical, 166  
 low-temperature expansion, 172, f8.7 172, e8.2 175  
 $M(T)$  plot, f8.2 164  
 magnet, 164  
   spins either quantum or classical, n7 164  
 mean-field theory, e12.5 284  
 Monte Carlo, 166  
   Bortz–Kalos–Lebowitz algorithm, n36 179  
   continuous-time, n36 179  
   heat-bath algorithm, 166, e8.7 176  
   Metropolis algorithm, e8.6 176, e8.7 176  
   Wolff algorithm, e8.8 177, e8.9 177  
 no analytic solution in three dimensions, 166  
 non-conserved order parameter (usually), 248  
 nucleation, e11.4 253  
 Onsager solution in two dimensions, 166  
 paramagnetic phase, 164  
 phase diagram,  $H$ – $T$ , f8.5 166, e8.1 174  
 phase diagram,  $M$ – $T$ , f8.2 164  
   with low-temperature series, f8.7 172  
 phase separation, f10.1 216, f11.7 247  
 pronunciation, 163  
 random field  
   and hysteresis, e8.13 182, e8.14 185, e12.13 296  
   equilibrium glassy behavior, 280  
   self-similarity, e12.1 282  
   three-site, long-range interactions, 165  
 transfer matrix, exact diagonalization,  $1/N$ ,  $4 - \epsilon$ , 166
- Isolated system, 37
- Isothermal  
 steps in Carnot cycle, f5.3 79
- Isothermal bulk modulus, not for sound, n56 160
- Jensen's inequality, n36 88  
 generalization, e8.12 182
- Jordan canonical form, and Markov chain, n16 168
- Jupiter, and the three-body problem, e4.4 72
- k-space experiments, *see* Diffraction experiments
- KAM  
 good irrational, n30 74  
 theorem, 68, e4.4 74  
 and chaos, 68  
 winding number, e4.4 74  
 tori, f4.3 66, f4.7 73, e4.4 74  
 and ergodicity breakdown, 68  
 KdV equation and ergodicity, 68  
 Kelvin damping and Galilean invariance, e9.6 210, e10.9 240
- Kick, linear response to, 215
- Kolmogorov, Arnol'd, Moser, *see* KAM
- Korteweg–de Vries equation, and ergodicity breakdown, 68
- Kosterlitz–Thouless–Halperin–Nelson–Young theory of two-dimensional melting., n39 235
- Kramers theory of chemical reaction rates, e6.11 130
- Kramers–Krönig relation, 229–31  
 formula for reactive  $\chi'(\omega)$  in terms of dissipation  $\chi''(\omega)$ , vice versa, 229  
 from  $i$  in Cauchy's integral formula, 230  
 from causality, 229  
 tricky to verify, e10.3 235
- kSAT, *see* Logical satisfiability
- Lagrange multipliers, e6.6 128
- Landau Fermi liquid theory, n23 144  
 renormalization group, n23 144, e12.8 286
- Landau theory, e9.5 206  
 accurate for superconductors, n33 209  
 and mean-field theory, e12.5 284  
 domain wall energy, e9.4 206  
 gives incorrect critical exponents, e9.5 209  
 ignores fluctuations, e9.5 209  
 Ising model, e9.4 206  
 non-convex free energy, n32 208  
 not quantitative for interfaces or defect cores, n27 207
- Langevin equation, e10.7 238  
 as heat bath for molecular dynamics, e10.7 238  
 dissipation balanced by noise, e10.7 238
- Laplace transform, e6.5 127
- Large numbers, e3.2 54

- multiplying energy-shell volume by constant irrelevant, n47 **51**
- Large, humans compared to atoms, e9.6 **209**
- Laser
  - acronym definition, n47 **156**
  - analogy to superflow, e9.7 **211**
  - and gregarious photons, e7.9 **156**
  - as Bose condensate, e7.2 **153**, e7.9 **156**
  - as phase, e12.6 **284**
  - macroscopically occupied quantum state, e9.7 **211**
  - negative temperature, e6.3 **125**
  - onset, as phase transition, with scaling, e12.6 **285**
  - population inversion, e7.9 **156**, e12.6 **284**
  - tweezer and molecular motor, f2.9 **27**, f6.11 **126**
- Lasso
  - basketball, cannot, f9.13 **199**
  - hemisphere, can, f9.14 **200**
- Latent heat
  - abrupt phase transition, n3 **241**
  - boiling water, 600 cal/g, n3 **241**
  - related to entropy change at transition, 243
- Lattice gas, 166
- Lattice models, 163
- Lattice quantum chromodynamics
  - emergent translational, rotational, Lorentz symmetry, 265
- Law of mass action, *see* Mass-action law, chemical reactions
- Legendre transform, 116, e6.7 **128**
  - and Wulff construction, equilibrium crystal shape, f11.6 **247**
- Lennard–Jones interatomic potential, e10.2 **234**
- Leslie–Ericksen liquid crystal free energies, n22 **206**
- Levy flights, 25
- Life
  - at heat death of Universe, 81, e5.1 **91**
  - intercepting entropy flows, e5.1 **91**
- Lindemann criterion of melting, e10.2 **235**
- Linear response, n43 **122**, 222–31
  - equilibrium relations to correlations, 218
  - to gentle kick, 215
- Linear stability analysis, dendritic growth, e11.9 **260**
- Liouville numbers, nearly rational, e4.4 **75**
- Liouville’s theorem, 63–5
  - and area conservation in maps, n47 **95**
  - and constant microscopic entropy, e5.7 **95**
- microcanonical ensemble time
  - independent, 65
- no analogue in statistics, e6.14 **133**
- no attractors, 65
- not obeyed in dissipative systems
  - Feigenbaum map, e4.3 **70**
  - pendulum, e4.2 **70**
- phase-space flow incompressible, 65, f4.2 **65**
- quantum, 138
  - not as useful as classical, 139
- Liquid
  - coordination number, e10.2 **234**
  - pair distribution function, e10.2 **234**
  - symmetric ensemble of disordered snapshots, 192
- Liquid crystal
  - many phases, 191
  - nematic, f9.5 **194**
    - as American footballs, 194
    - LCD display, 194
    - order parameter space hemisphere, f9.5 **194**
- Liquid–gas transition, 166
  - avoiding, circling critical point, f6.14 **129**, f8.4 **166**
  - critical point, 166
  - Ising critical point, 166, 266
  - phase diagram,  $T$ – $\rho$ , f12.6 **267**
  - liquid–gas transition,  $P$ – $T$ , f8.4 **166**
  - phase diagram,  $P$ – $T$ , f6.14 **129**
  - phase diagram,  $T$ – $V$ , f11.1 **241**
- Local conservation, and current, 20, 64, 122, 248
  - always use current to derive dynamics, n18 **21**
- Localization, 278
- Logical satisfiability, e1.8 **12**, e8.15 **187**
  - conjunctive normal form, e1.8 **13**
  - Davis–Putnam algorithm, e8.15 **187**
  - WalkSAT, SP algorithms, e8.15 **189**
- Logistic map
  - boundaries, e4.3 **72**
  - fractal dimension at  $\mu_c$ , e5.16 **101**
  - invariant measure, e4.3 **70**
  - Lyapunov exponents, e5.9 **96**
  - period-doubling cascade, renormalization group, e12.9 **288**
- Long-range order
  - in magnets, analogous to superfluids, e9.8 **212**
  - in time, glass, 280
  - measured by correlation function, 216
  - off-diagonal, in superfluids and superconductors, 136, e9.8 **212**
  - orientational, in nematics, f9.19 **203**
- Lorentz invariance
  - broken by Big Bang, n30 **232**
- emergent, lattice quantum chromodynamics, 265
  - yields mass and spin quantum numbers, 306
- Losing keys, and entropy, 87
- Lossless data compression and entropy, n33 **87**, e5.15 **100**
- Lossy data compression and entropy, n33 **87**, e5.14 **100**
- Low-temperature expansion
  - Feynman diagram cluster, f8.7 **172**
  - Ising model, 172, f8.7 **172**, e8.2 **175**
- Lyapunov exponents, e5.9 **96**
- Macroscopically occupied quantum state, superfluids and lasers, e9.7 **211**
- Magnet
  - breaks time-reversal invariance, n4 **193**
  - Curie’s law, e8.2 **175**
  - Heisenberg, order parameter  $\mathbf{M}(\mathbf{r}) \in \mathbb{S}^2$ , 193
  - phase diagram,  $H$ – $T$ , f8.5 **166**, e8.1 **174**
  - phase diagram  $M$ – $T$ , f12.6 **267**
  - phase diagram,  $M$ – $T$ , f8.2 **164**
    - with low-temperature series, f8.7 **172**
- Magnetization
  - fluctuations, and susceptibility, e8.2 **174**
  - scaling function, 277
- Many-body energy eigenstates, peculiar, n10 **139**
- Map
  - Arnol’d cat, e5.8 **95**, f5.16 **96**
  - Feigenbaum
    - boundaries, e4.3 **72**
    - fractal dimension at  $\mu_c$ , e5.16 **101**
    - invariant measure, e4.3 **70**
    - Lyapunov exponents, e5.9 **96**
    - period-doubling cascade, renormalization group, e12.9 **288**
    - Poincaré first return, e4.4 **72**, f4.8 **74**
    - related to continuous dynamics, n50 **97**
  - Marginal operator, renormalization group, e12.8 **287**, e12.11 **293**
  - Markov chain, 167–71
    - and Jordan canonical form, n16 **168**
    - asymptotic states, e8.4 **175**
    - coin flips, e8.3 **175**
    - continuous time or space, n13 **167**, e10.5 **236**
    - cycles, 169
    - detailed balance, 170, e8.5 **176**
    - equilibrates, if ergodic and detailed balance, 171
    - equilibrium state, 169
    - ergodic, 169
    - has no memory, 167
    - Ising model, heat-bath, 167

- mathematicians call ‘regular’, n20 **169**  
 non-unique stationary states, 169  
 Perron–Frobenius theorem, 169  
 probabilistic transition rule, 167  
 red, green bacteria, 168, e8.4 **175**  
 transient states, 169  
 transition matrix  
   decay time from second-largest  
   eigenvalue, e8.4 **175**, e10.5 **236**  
   left and right eigenvectors, 168,  
   e10.5 **236**  
   not symmetric  $P_{\alpha\beta} \neq P_{\beta\alpha}$ , 168  
 waiting for Godot, e8.3 **175**  
 Wolff algorithm, e8.8 **177**  
   implementation, e8.9 **177**
- Markovian heat bath, leads to viscous  
   friction, e10.7 **238**  
 Markovian: no memory, 167  
 Martensite, 250  
   and origami, e11.7 **255**  
   as minimizing sequence, e11.8 **258**  
   boundary conditions induce  
   microstructure, 250, e11.7 **257**  
   compatibility condition, e11.7 **256**  
   crystal shape transition, 250  
   deformation field, e11.7 **255**  
   free energy minimum not attained,  
   e11.8 **258**  
   layered laminate structure, 250,  
   e11.8 **258**  
   variants, f11.11 **250**, e11.7 **255**  
   Young measure, e11.8 **259**
- Mass, spin, from group representation  
   theory, 306  
 Mass-action law, chemical reactions,  
   118–20  
   naive motivation, 118  
 Mass-energy, of photons and matter in  
   Universe, e7.15 **160**
- Master equation, e10.5 **236**
- Mathematics exercises, e1.3 **6**, e1.4 **7**,  
   e1.5 **7**, e1.6 **8**, e1.8 **12**, e3.10 **58**,  
   e3.11 **58**, e4.2 **70**, e4.3 **70**,  
   e4.4 **72**, e5.7 **95**, e5.8 **95**,  
   e5.9 **96**, e5.13 **99**, e5.14 **100**,  
   e5.16 **101**, e5.17 **102**, e7.4 **153**,  
   e7.8 **155**, e8.3 **175**, e8.4 **175**,  
   e8.6 **176**, e8.8 **177**, e8.12 **182**,  
   e8.15 **186**, e9.1 **203**, e9.2 **204**,  
   e9.3 **205**, e11.7 **255**, e11.8 **258**,  
   e12.4 **283**, e12.6 **284**, e12.9 **288**,  
   e12.10 **291**, e12.11 **291**,  
   eA.10 **311**
- Mathematics, unreasonable effectiveness  
   of, emergent, n1 **15**
- Maxwell equal-area construction,  
   f11.3 **244**, 243–4  
   makes sense only in mean field,  
   n11 **244**  
   van der Waals, e11.1 **251**
- Maxwell relations, e3.11 **58**
- Maxwell’s demon  
   as biological ion pump, f5.6 **83**  
   entropic limits to, 83, e5.2 **92**
- Maxwell–Boltzmann  
   compromise, democratic bosons vs.  
   exclusive fermions, 145  
   distribution, occupation of  
   non-interacting states,  
   f7.4 **142**, 146  
   non-interacting  
   grand free energy, 146  
   grand partition function, 146  
   partition function, 145  
   quantum statistics  
   bogus, 145  
   vs. distinguishable particles, n24 **145**  
   statistics, 53
- Maxwellian velocity distribution, e1.2 **6**,  
   44, 111
- Mean-field theory, e12.5 **284**  
   and Landau theory, e12.5 **284**
- Mechanics, friction, and fluctuations,  
   117, 227, e10.3 **235**, e10.7 **238**
- Meissner effect  
   related to no Goldstone mode in  
   superconductor, 197
- Melting  
   Lindemann criterion of, e10.2 **235**
- Memory tape, frugal, one atom per bit,  
   e5.2 **91**
- Mermin–Wagner theorem  
   no 2D continuous broken symmetries,  
   n12 **198**  
   not for 2D crystal orientations,  
   n12 **198**
- Metallic glass, 84  
   defect entanglement theory, 202  
   frustration, f12.18 **281**
- Metals, 150–1  
   surprisingly, as non-interacting  
   fermions, 144
- Metastable state, 243  
   imaginary part of free energy gives  
   nucleation rate, n9 **243**  
   mean-field theory, e12.5 **284**  
   perturbatively defined because  
   nucleation rate has essential  
   singularity, n15 **246**  
   supercooled vapor  
   110% humidity, n8 **243**  
   superheated liquid, 243  
   well defined when nucleation slow, 243
- Metropolis Monte Carlo, e8.6 **176**  
   implementation, e8.7 **176**  
   slightly faster than heat-bath,  
   e8.6 **176**, e8.7 **176**
- Michaelis–Menten chemical reaction  
   rate, e6.12 **131**
- Microcanonical ensemble, 37–9  
   all states created equal, 39, 65  
   and Lagrange multiplier, e6.6 **128**  
   assumes ergodic: time average equals  
   microcanonical average, 66  
   chaos justification, 38  
   chemical potential, 47–8  
   comparing Bose, Fermi,  
   Maxwell–Boltzmann,  
   distinguishable, e7.1 **152**  
   conserved energy, 38  
   energy shell, 38  
   thickness for quantum, n9 **38**  
   equivalent to canonical, 108, e6.3 **126**  
   ideal gas, 39–44  
   ignorance justification, 38, 63  
   isolated system, 37  
   less convenient than canonical, 109  
   Liouville’s theorem, 63–5  
   momentum distribution, 42–4  
   negative temperature, e6.3 **125**  
   pressure, 47–51  
   probability density  $\delta(E - \mathcal{H})/\Omega$ ,  
   n10 **38**  
   regression to the mean, 39, 65  
   subsystems compete for energy,  
   n35 **46**, 109  
   time independent, from Liouville, 65  
   velocity distribution, classical, 44,  
   e4.1 **70**  
   weakly-coupled systems  
   all states equal with fixed  $E_{\text{tot}}$ , 45  
    $\Omega(E) = \int dE_1 \Omega_1(E_1)\Omega_2(E - E_1)$ ,  
   n31 **45**, e3.6 **55**  
    $\rho(s_1) \propto \Omega_2(E - E_1)$ , 45
- Microstructure  
   bewildering variety, non-universal, 250  
   dendritic, 250–1  
   martensitic, 250  
   and origami, e11.7 **255**  
   of phases, 246–51
- Microwave background radiation,  
   e7.15 **159**, e10.1 **231**  
   and absolute velocity of Sun, e10.1 **232**  
   correlation function, f10.14 **232**  
   fluctuation map, f10.13 **232**  
   temperature, e5.1 **91**
- Minimizing sequence, and martensites,  
   e11.8 **258**
- Mixed state, 135–9  
   operator expectation value, 136  
   photon, n2 **136**  
   photon polarization, e7.5 **154**  
   spin, time evolution, e7.6 **154**
- Mixing, entropy of, 82
- Mobility, in diffusion equation, 21, 122  
   dilute limit, 21  
   hydrodynamic limit, 21  
   sign, explained, 22
- Molecular dynamics  
   equilibration time, e4.1 **69**

- exponential atmosphere, e6.1 124  
 Langevin as heat bath, e10.7 238  
 often uses Verlet algorithm, e3.12 59  
 pair distribution function, e10.2 233  
 pressure and wall collisions, e3.4 54  
 random walk, e2.4 27  
 stability often bottle-neck, e3.12 60  
 velocities Maxwellian, n28 44
- Molecular motor**, f2.7 26  
 free energy, e6.4 126  
 random walk of, e2.3 26
- Molecular rotations, vibrations, and free energy**, n54 56, n31 119
- Moment**, of probability distribution, definition, n12 20
- Momentum distribution**  
 canonical, 111  
 classical, independent of potential energy, 111, e6.1 125  
 microcanonical, 42–4
- Momentum space**, n5 37
- Monte Carlo**  
 as Markov chain, 167  
 Bortz–Kalos–Lebowitz algorithm, n36 179  
 cluster-flip algorithm, e8.8 177, e8.9 177  
 continuous-time algorithm, n36 179  
 gambling center in Monaco, n12 166  
 Gillespie algorithm, chemical reactions, e8.10 179, e8.11 180  
 heat-bath algorithm, 166, e8.7 176  
 thermalizes one site at a time, 167
- Ising model**, 166
- Metropolis algorithm**, e8.6 176, e8.7 176  
 slightly faster than heat-bath, e8.6 176, e8.7 176
- renormalization group, 269
- Swendsen–Wang algorithm**, e8.8 177
- Wolff algorithm**, e8.8 177  
 bypasses critical slowing-down, e8.8 177, e8.9 177  
 implementation, e8.9 177  
 much faster than heat-bath, Metropolis near  $T_c$ , e8.8 177, e8.9 177
- Morphology**  
 bewildering variety, non-universal, 250  
 coarsening, 246–50  
 dendritic, 250–1  
 martensitic, 250  
 and origami, e11.7 255  
 of phases, 246–51
- Most general**  
 evolution equation, e9.6 209  
 free energy density, e9.5 207
- mRNA**, messenger RNA, n40 180
- $M$ – $T$  phase diagram**, f12.6 267  
 Ising model, f8.2 164  
 with low-temperature series, f8.7 172
- Multifractals**, e5.16 102
- $\text{Na}^+/\text{K}^+$ -ATPase as Maxwell’s demon**, f5.6 83
- Negative**  
 specific heat, black hole, e5.4 94  
 temperature, e6.3 125
- Nematic**, f9.5 194  
 as American footballs, 194  
 biaxial, defect entanglement theory, 202  
 disclination, e9.1 203  
 own antiparticle, 200, e9.1 203  
 topological defect, f9.14 200  
 LCD display, 194  
 order parameter  $\mathbf{n}(\mathbf{r}) \in \mathbb{R}P^2$ , 194  
 order parameter space hemisphere, f9.5 194
- Nernst’s theorem**, 115, e7.3 153
- Network**  
 bond percolation, f2.12 33  
 $p_c$  and near  $p_c$ , f12.2 264  
 dimerization reaction, f8.11 178  
 repressilator, f8.13 181  
 site percolation, f2.13 35  
 small world, f1.5 10
- Neutrinos**  
 and electrons, hard materials to build life from, n46 94  
 decoupling after Big Bang, n52 159  
 hard to confine, n22 144
- Neutron star**  
 as Fermi gas of neutrons, e7.16 161  
 stellar collapse into, e7.16 161  
 stellar collapse of, e7.16 161  
 surprisingly, as free Fermi gas, 144
- Newton, Isaac**, used wrong bulk modulus for sound, n56 160
- Noise**, *see also* Fluctuations  
 Barkhausen, in magnets, e8.13 182, f8.14 183  
 telegraph, e10.5 236  
 definition, n53 127  
 in nanojunctions, f10.16 236  
 in RNA unzipping, f6.13 127  
 thermal, and Langevin equation, e10.7 238
- Non-adiabatic, fast motions which generate entropy**, 49, 78
- Non-convex free energy**  
 Landau theory, f9.22 208, n32 208  
 martensites, 250  
 yields laminate microstructure, e11.8 258
- mean-field theory, e12.5 284  
 one-dimensional staircase model, e11.8 258
- Non-equilibrium entropy**, 86
- Non-interacting**  
 amazing utility of approximation, 144  
 bosons, *see* Boson, non-interacting  
 fermions, *see* Fermion, non-interacting  
 particles, 141–51  
 planet approximation, KAM theorem, e4.4 73  
 undistinguished particles, *see* Undistinguished particles, non-interacting
- Normal distribution**, *see* Gaussian
- Normal form and scaling functions**, e12.4 283
- NP-complete problems**, n16 12, e8.15 186  
 3SAT, e8.15 187  
 demonstrating new, e8.15 187  
 hard in worst case, e8.15 187  
 logical satisfiability (SAT), e1.8 12, e8.15 187  
 statistical mechanics for typical difficulty, e8.15 187  
 traveling salesman, graph coloring, spin-glass, e8.15 186
- Nucleation**, 244–6  
 carbon precipitates in cast iron, 246  
 cloud seeding, ice-nucleating bacteria, n16 246  
 critical droplet as barrier, 245  
 dew, fog, clouds, 244  
 dislocation pair, e11.5 254  
 driving force from undercooling, 245  
 free energy barrier, f11.5 245  
 diverges at transition, 246, e11.5 255  
 homogeneous, rarely dominant, 246  
 ice crystal, snowflake model, e11.9 259  
 Ising model, field reversal, e11.4 253  
 rare fluctuations, in tail, n14 246  
 rate, 245  
 dominated by dust, interfaces, 246  
 essential singularity at  $T_b$ ; allows metastable state theory, n15 246  
 exponentially small near transition, 246  
 given by imaginary part of free energy, n9 243  
 Ising model, e11.4 253  
 power-law dependence for 2D dislocations, e11.5 255  
 predict barrier instead, e11.4 254  
 prefactors not as important as barrier, 245  
 vs. spinodal decomposition, n10 243
- Number conservation, Hamiltonian invariance**  $a \rightarrow ae^{-i\zeta}$ , e9.8 213
- Number fluctuations**, 40, e3.9 57  
 Gaussian, e3.9 57  
 grand canonical ensemble, 113  
 in small volume of cell, e8.10 178  
 tiny for large system, 41



- Number indeterminacy in superfluids,  
not just grand canonical  
ensemble, n38 [212](#)
- ODLRO, 197  
Bose condensate, e9.8 [212](#)  
breaks particle number conservation,  
n5 [195](#), e9.8 [212](#)  
broken gauge invariance, e9.8 [213](#)  
superfluids and superconductors, 136,  
e9.8 [211](#)
- Off-diagonal long-range order, *see*  
ODLRO
- Oil, water, and alcohol; ternary phase  
diagram, f8.8 [173](#)
- Onsager  
solution of two-dimensional Ising  
model, 166
- Onsager's regression hypothesis, 220–2  
applied to one-dimensional magnet,  
e10.8 [239](#)  
derive from quantum mechanics,  
n25 [229](#)  
determines dynamics, 220  
same decay, fluctuations and  
perturbations, 221  
testing in Ising model, e10.6 [237](#)
- Onset of chaos, 279, e12.9 [288](#)
- Operator sites, regulating transcription  
DNA to RNA, e8.11 [180](#)
- Optics exercises, e7.8 [155](#), e7.9 [156](#),  
e12.6 [284](#)
- Option, call, e2.12 [32](#)  
European vs. American style, n38 [32](#)
- OR  
gate, exclusive, and irreversible  
computation, e5.3 [93](#)  
inclusive  $\vee$ , and logical satisfiability,  
n17 [13](#)
- Orange peel carpet, and frustration,  
f12.18 [281](#)
- Order parameter, f9.4 [193](#)  
as field, 193  
as mapping from real to order  
parameter space, 194  
Bose condensate  $\psi(r)$ , e9.7 [211](#)  
choice as art, 194  
field, 121  
ideal gas, f6.8 [121](#), f6.9 [122](#)  
'hard-spin', 194  
important variables for system, 192  
Landau, for Ising model, e9.5 [207](#)  
Landau, near transitions and defect  
cores, 194  
magnet, 192  
martensite, deformation field,  
e11.7 [255](#)  
quantum field as, n3 [192](#)  
'soft-spin', 194  
superfluids and superconductors  $\psi(r)$ ,  
e9.7 [211](#)  
expectation of annihilation operator  
( $a$ ), e9.8 [212](#)  
from ODLRO, e9.8 [212](#)  
topological, low temperature, 194  
variation in space, 193
- Order parameter space, f9.4 [193](#)  
 $\mathbb{S}^2$  for magnet, 193  
crystal is torus, f9.6 [194](#)  
folded paper, f11.16 [256](#)  
 $\mathbb{R}P^2$  for nematic, 194  
 $\mathbb{S}^1$  for Bose condensate, superfluid,  
superconductors, 195, e9.7 [211](#)  
 $\mathbb{S}^1$  for XY model, e9.2 [204](#)  
 $\mathbb{T}^d$  for crystal in  $d$  dimensions, 195
- Order, of phase transition; use *abrupt* or  
*continuous*, n7 [243](#)
- Oriental symmetry, *see* Rotational  
symmetry
- Origami, and martensites, e11.7 [255](#),  
f11.18 [257](#)
- Osmotic pressure  
and chemical potential, 48  
and entropy, n17 [83](#)  
salt, and blood pressure, f5.6 [83](#)
- Overdamped oscillations, at short  
wavelengths, e10.9 [240](#)
- $P = NP?$ , e8.15 [187](#)
- Padé approximant, f8.2 [164](#), f8.7 [172](#),  
n26 [172](#)
- Pair distribution function  
and form factors, n6 [217](#)  
liquids, gases, and crystals, e10.2 [233](#)
- Paramagnet, 164
- Partial trace  
and chemical equilibrium, 120  
canonical ensemble, n5 [107](#)  
definition, n14 [112](#)  
grand canonical as, of canonical  
ensembles, 112  
integrating over internal variables,  
n15 [112](#)  
leaving discrete system, n33 [120](#)  
pollen effective potentials, e6.13 [132](#)  
thermal position fluctuations in binary  
alloy, n9 [165](#)
- Particle accelerators and area-conserving  
maps, n47 [95](#)
- Particle and heat exchange, grand  
canonical ensemble figure,  
f6.3 [112](#)
- Partition function  $Z$ , 106  
as normalization factor, 107  
entropy, 108  
factors for uncoupled systems, 109  
harmonic oscillator  
classical, 111  
quantum, 139  
Helmholtz free energy, 108  
ideal gas, 110  
internal energy, 107  
specific heat, 107
- Path integral  
and homotopy theory, n20 [205](#)  
and instantons, n16 [200](#)  
and order parameter field  
configurations, n22 [225](#)
- Pauli exclusion principle, 142, 145
- Pendulum  
as Hamiltonian system, numerical,  
e3.12 [58](#)  
damped, vs. Liouville's theorem,  
e4.2 [70](#)
- Percolation, e2.13 [33](#), 263, 266–7,  
e12.12 [293](#)  
bond, f2.12 [33](#)  
connectivity transition, e2.13 [34](#)  
continuous transition, 263  
does not demand equilibrium  
statistical mechanics, e2.13 [34](#)  
but is one-state Potts model, n43 [34](#)  
duality, e2.13 [34](#)  
ensemble of hole punch patterns,  
e2.13 [33](#), 263  
 $p_c$  and near  $p_c$ , f12.2 [264](#)  
site, f2.13 [35](#)  
site vs. bond, f12.7 [268](#)
- Perfume  
as ideal gas without conserved  
momentum, 122, 220  
as random walk, 16, e2.4 [27](#)  
constant rain solution, n19 [22](#)  
diffusion equation, 19, 220  
final state uniform, 22  
in gravity final state exponentially  
decays, 22  
primarily transported by convection,  
n4 [16](#)
- Period doubling  
cascade, onset of chaos, e12.9 [289](#)  
renormalization group, e12.9 [288](#)
- Periodic boundary conditions, n28 [146](#)  
Ising model, n5 [164](#)  
molecular dynamics, n30 [27](#)  
wrapping a torus, f9.7 [195](#)
- Permutation, sign, even and odd,  
n15 [140](#)
- Perpetual motion machine, 78, f5.1 [78](#)
- Perron–Frobenius theorem, and Markov  
chains, 169
- Perturbation theory, 171–3  
asymptotic series, e1.5 [7](#), 172  
breakdown at superconducting  $T_c$ ,  
e12.8 [286](#)  
cannot converge past phase boundary,  
173  
convergence defining phase, almost,  
173  
 $\epsilon$ -expansion, 172, 269  
fails for three-body problem, e4.4 [73](#)

- Fermi liquid theory, 172  
 high-order, 172  
   heroic, n26 [172](#)  
 high-temperature expansion, 172,  
   e8.2 [175](#)  
 infinite-order, to change phases, 173  
 low-temperature expansion, f8.7 [172](#),  
   e8.2 [175](#)  
   cluster, f8.7 [172](#)  
   Ising model, 172  
 Padé approximant, f8.2 [164](#), f8.7 [172](#),  
   n26 [172](#)  
 true to all orders inside phase,  
   e12.8 [286](#)  
 true to all orders is not necessarily  
   true, e12.8 [286](#)  
 virial expansion, 172  
 works inside phases, 171
- Petri net  
 for dimerization reaction, f8.11 [178](#)  
 for part of repressilator, f8.13 [181](#)
- Phase  
 almost defined as perturbative region,  
   171–3  
 almost defined by broken symmetry,  
   n2 [192](#)  
 as renormalization-group fixed point,  
   271  
 examples: ice/water/vapor, Ising  
   ferromagnet/paramagnet,  
   Bose condensation, 171  
 multitudes, 191  
 solid, liquid, gas, 191  
 vacuum in early Universe, 191
- Phase coexistence, 242  
 avoided by grand canonical ensemble,  
   n5 [242](#)  
 avoided using Gibbs free energy, 242  
 line, Clausius–Clapeyron equation,  
   e6.10 [129](#)  
 Maxwell construction, 243  
 temperature, pressure,  $\mu$  equal, 242
- Phase diagram  
 alloy, from lattice simulations, 165  
 Ising model,  $H$ – $T$ , f8.5 [166](#), e8.1 [174](#)  
 Ising model,  $M$ – $T$ , f8.2 [164](#)  
   with low-temperature series, f8.7 [172](#)  
 liquid–gas transition,  $T$ – $\rho$ , f12.6 [267](#)  
 liquid–gas transition  $P$ – $T$ , f6.14 [129](#)  
 liquid–gas transition,  $P$ – $T$ , f8.4 [166](#),  
   f11.1 [241](#)  
 liquid–gas transition,  $T$ – $V$ , f11.1 [241](#)  
 magnet,  $H$ – $T$ , f8.5 [166](#)  
 magnet,  $M$ – $T$ , f8.2 [164](#), f12.6 [267](#)  
 ternary, for oil, water, and alcohol,  
   f8.8 [173](#)
- Phase separation, f10.1 [216](#)  
 called spinodal decomposition, n10 [243](#)  
 Ising model, f11.7 [247](#), e11.6 [255](#)
- Phase space, n5 [37](#)
- Heisenberg uncertainty invalidates,  
   135
- Phase-space volume  
 and very large numbers, e3.2 [54](#)  
 divided by  $h^{3N}$ , 52  
   general argument, n42 [153](#)  
   Nernst’s theorem, e7.3 [153](#)  
   quantum state counting, e7.3 [153](#)  
   semiclassical and path-integral  
   arguments, n42 [153](#)
- Gibbs factor  $1/N!$ , 52
- Phase transition  
 abrupt, *see* Abrupt phase transitions  
 continuous, 263–82  
 disordered systems, 280  
 dynamical systems, 279–80, e12.4 [283](#),  
   e12.9 [288](#)  
 glass, theories of, 280–1  
 onset of chaos, e12.9 [288](#)  
 onset of lasing, e12.6 [284](#)  
 order, *see* *abrupt* or *continuous* phase  
   transition, n7 [243](#)  
 perturbation theory fails, 173  
 properties not smooth, 173  
 quantum, 278–9  
 $\phi^4$  model, e9.5 [208](#)
- Phonon, 196  
 as Goldstone mode, 196  
 boson, e7.2 [152](#)  
 on a string, e7.11 [157](#)
- Photon  
 black-body radiation, 147–8  
 boson, e7.2 [152](#)  
 decoupling after Big Bang, e7.15 [159](#)  
 dominated Universe, e7.15 [160](#)  
 emission from small hole, e7.7 [154](#)  
 four kinds in early Universe, 191  
 random walk in Sun, e2.2 [26](#)  
 unpolarized, as mixed state, n2 [136](#),  
   e7.5 [154](#)
- Piston  
 and heat engine, f5.2 [78](#)  
 exchanging volume between  
   subsystems, f3.3 [47](#)  
 fast moving, generating entropy, 49, 78  
 resetting bits on digital tape, e5.2 [92](#)
- Pit and island evolution, surface,  
   f10.2 [216](#)
- Pitchfork bifurcation, e12.4 [283](#)
- Planck black-body radiation, *see*  
 Black-body radiation
- Planck distribution  
 and stimulated emission, e7.8 [155](#)  
 cosmic microwave background  
   radiation, f7.17 [159](#), e10.1 [231](#)  
 emission from black body, 148  
 emission from small hole, e7.7 [154](#)
- Planetary dynamics, vs. ergodicity,  
   e4.4 [72](#)
- Plasma frequency, and Higgs mechanism  
   for superconductor, n11 [197](#)
- Plasticity, dislocation mediated, 2D  
 superfluids and crystals,  
   n22 [254](#)
- Poincaré group invariance, yields mass  
 and spin quantum numbers,  
   306
- Poincaré section, e4.4 [74](#), f4.8 [74](#)  
 relates continuous dynamics to maps,  
   n50 [97](#)  
 three-body problem, f4.3 [66](#)
- Poisson probability distribution, e3.9 [57](#)
- Polarizability  $\alpha(\omega)$   
 related to conductivity  
    $\sigma = \lim_{\omega \rightarrow 0} \omega \alpha''(\omega)$ , 224  
 tensor for anisotropic materials,  
   n16 [222](#)  
 vs. dielectric permittivity  $\epsilon(\omega)$ ,  
   n16 [222](#)
- Poles, in susceptibility, as damped  
 modes, e10.9 [240](#)
- Polyatomic molecules, free energy,  
   n31 [119](#)
- Polycrystal, coarsening rate and grain  
 size, 247
- Polymer  
 as self-avoiding random walk, 19,  
   e2.10 [30](#)  
 some compact, not random walk, n8 [19](#)
- Pool game, entropy increase and arrow  
 of time, 80
- Population inversion  
 and lasing, e7.9 [156](#), e12.6 [284](#)  
 and negative temperature, e6.3 [125](#)
- Potts model, n18 [278](#)
- Power law  
 as heavy-tailed distribution, e8.15 [188](#)  
 avalanche size distribution,  $R_c$ , 272–4  
 correlation function decay, 217,  
   f10.5 [218](#)  
 earthquake sizes (Gutenberg–Richter),  
   f12.3 [265](#), 274  
 length of random walk, 19  
 only self-similar function, n15 [275](#)  
 singularity in susceptibility, specific  
   heat, correlation length at  
   critical point, 266
- Power spectrum  
 and correlation function, 303  
 definition, n11 [302](#)
- Prefactor, for chemical reaction rates,  
 transition state theory,  
   e6.11 [129](#)
- Pressure  
 defined for adiabatic volume change,  
   50  
 equal at phase coexistence, e6.10 [129](#),  
   242

- equal when volume shifts to maximize entropy, 47, f3.3 47
- from energy,  $P = -(\partial E/\partial V)|_{S,N}$ , 48
- from entropy,  $P = T(\partial S/\partial V)|_{E,N}$ , 47
- from wall collisions, e3.4 54
- hard sphere gas, e3.5 55
- ideal gas, 52
- intensive variable, 46
- microcanonical, 47–51
- of photons and matter in Universe, e7.15 160
- relation to mechanics  $P = -\Delta E/\Delta V$   
microscopic derivation, 48
- Pressure–volume diagram, *see*  $P$ – $V$  diagram
- Prior, use in Bayesian statistics, vs. Liouville’s theorem, e6.14 133
- Probability density
- confused with probability, 40
  - evolution has conserved current, 64
  - sloppy notation, name  $\rho$  used everywhere, n24 42, n32 45, n44 154
- Probability distribution, e1.2 5
- discrete as  $\delta$ -functions, n11 19
  - exponential, e1.2 5
  - Gaussian, e1.2 5
  - heavy tails, e8.15 188
  - Maxwellian, e1.2 6
  - mean, e1.2 5
  - moment, n12 20
  - multidimensional, e1.2 6
  - normalization, e1.2 5
  - of sum of random variables, e1.2 6
  - Poisson, e3.9 57
  - standard deviation, e1.2 5
  - uniform, e1.2 5
  - velocity, e1.2 6
- Projective plane
- hemisphere, f9.5 194
  - order parameter space for nematic, 194
- Proliferation: cellular reproduction, e8.11 180
- Proton decay, and life at heat death of Universe, e5.1 91
- Pseudomonas syringae*, ice-nucleating bacteria, n16 246
- $P$ – $T$  phase diagram, liquid–gas transition, f6.14 129, f8.4 166, f11.1 241
- Pulsar, *see* Neutron star
- Pure state, density matrix, 137
- $P$ – $V$  diagram
- and Carnot cycle, f5.3 79
  - and heat engine, e5.5 94
  - area related to work done, 79
- Quality factor, for decaying oscillations, e10.9 240
- Quantum
- canonical ensemble
    - $\rho = e^{-\beta\mathcal{H}}/(\text{Tr } e^{-\beta\mathcal{H}})$ , 137
  - computation, no minimum cost for, e5.3 93
  - density matrix, *see* Density matrix
  - Heisenberg uncertainty vs. classical phase space, 135
  - Liouville’s theorem, 138
    - not as useful as classical, 139
  - mechanics, not needed for statistical mechanics, v
  - mixed state, 135–9
    - operator expectation value, 136
    - photon, n2 136
    - photon polarization, e7.5 154
    - spin, time evolution, e7.6 154
  - of circulation, in superfluids, e9.7 211
  - particle in box, 146
    - eigenstates, f7.6 146
  - statistics, 140–1
    - comparing Bose, Fermi, Maxwell–Boltzmann, distinguishable, e7.1 151
    - Maxwell–Boltzmann at low occupancy, high  $T$ , 143
    - wavefunction symmetrization, antisymmetrization, 140
  - two kinds of probability, 135
- Quantum chromodynamics, lattice:
- emergent translational, rotational, Lorentz symmetry, 265
- Quantum criticality, 278–9
- Kondo effect, macroscopic quantum coherence, quantum Hall transitions, 278
  - localization and mobility edge, 278
  - superconductor–insulator transition, f12.15 279
    - scaling collapse, f12.15 279
    - unexplained, 279
  - zero-point fluctuations vs. energy, 278
- Quantum exercises, e1.1 4, e1.6 8, e7.1 151, e7.2 152, e7.3 153, e7.4 153, e7.5 154, e7.6 154, e7.7 154, e7.8 155, e7.9 156, e7.10 157, e7.11 157, e7.12 157, e7.13 158, e7.14 158, e7.16 161, e9.7 210, e9.8 211, e12.6 284
- Quantum field, as order parameter, n3 192
- Quantum mechanics
- determines dynamics in statistical mechanics, 220
  - microcanonical energy shell thickness, n9 38
  - not needed for statistical mechanics, 135
  - sets zero of entropy, 52, 115, e7.3 153
- Quantum statistical mechanics, 135–61
- governs solid-state, molecular, astrophysics, 135
  - restrict ensemble to wavefunctions with proper Bose, Fermi symmetry, 141
  - spawned quantum mechanics, 135
- Quantum tunneling, as origin of slow processes, n37 121
- Quasicrystal, 191, f9.1 191
- Quasiparticles
- and Fermi liquid theory, n23 144
  - and poles in susceptibility, e10.9 240
- $\mathbb{R}P^2$ , order parameter space for nematic, 194
- Radius of convergence
- distance to nearest complex singularity, e1.5 7, 173
  - Ising model low-temperature expansion, f8.7 172, 173
  - of Taylor expansions, 173
  - zero
    - for asymptotic series, e1.5 7
    - for some perturbation series, 172
    - quantum electrodynamics, and Hooke’s law, e1.5 8
- Random walk, 15–19, e2.5 28
- central limit theorem, f1.1 2, f2.6 24, e2.5 28
  - chemotaxis, 25
  - coin flips, 15–16
  - critical exponent  $\nu$ , 19
  - distance
    - measured as root-mean-square, 16
    - not mean displacement  $\langle x \rangle (= 0)$ , 16
    - not measured as mean absolute distance (non-analytic), n3 16
    - scales as  $\sqrt{N}$ , 16
  - drunkard’s walk, 16–17
  - ensemble yields diffusion equation, f1.1 2, f2.6 24
  - fractal dimension, n6 17, f2.2 18
  - generic scale invariance, 271
  - grade space, e2.1 25
  - heavy tails, e2.11 31
  - Levy flights, 25
  - molecular motor, e2.3 26
  - perfume molecule, 16, e2.4 27
  - persistence length, e2.10 30
  - scale invariance, f2.2 18
  - self-avoiding, 19, e2.10 30
  - solar photon, e2.2 26
  - stock price, f2.3 19, e2.11 31
  - sum of random variables, 15
- Random-field Ising model
- equilibrium glassy behavior, 280
  - equilibrium vs. hysteretic, n21 280
  - hysteretic, e8.13 182, e8.14 185, e12.13 296

- Rare fluctuations  
 critical droplet theory and instantons, n14 **246**  
 into ordered state, decreasing entropy, n10 **81**
- Ratchet and pawl, and molecular motors, e2.3 **27**
- Ratio test, and asymptotic series, e1.5 **7**
- Rayleigh–Jeans black-body radiation  
 formula, 148, f7.8 **148**
- Reaction coordinate, 120
- Reaction rates, *see* Chemical reactions
- Reactions, *see* Chemical reaction
- Real-space microscopy  
 complementary to  $k$ -space diffraction, 217  
 Fourier analyzed into correlation functions, 218  
 local geometries, mechanisms, 218
- Rectilinear diameter, law of, f12.6 **267**  
 singular corrections to, n2 **266**
- Red and green bacteria, Markov chain, e8.4 **175**
- Reduced density matrix, Bose condensate, superfluid, e9.8 **211**
- Refrigerator  
 efficiency estimate, e5.6 **95**  
 heat engine in reverse, 78  
 $P$ - $V$  diagram, f5.15 **94**
- Regression hypothesis, Onsager's, 220–2  
 derive from quantum mechanics, n25 **229**  
 determines dynamics, 220  
 same decay, fluctuations and perturbations, 221
- Regression to the mean, and equilibration, 39, 65
- Relativistic particle, dispersion relation, e7.2 **153**, e7.16 **161**
- Relevant perturbation, renormalization group, e12.8 **287**, e12.11 **293**  
 self-avoidance for random walks, n9 **19**
- Renormalization  
 of parameters on coarse-graining, e12.11 **292**  
 of parameters, on coarse-graining, 268  
 origin of term in quantum electrodynamics, n5 **267**
- Renormalization group, 267–72  
 and superconductivity, e12.8 **286**  
 continuum limit with fluctuations, 267  
 correction to scaling, e12.11 **293**  
 critical surface, n8 **271**  
 fixed point, 269, f12.8 **269**  
 flow, f12.8 **269**  
 and scaling function, e12.7 **285**  
 for central limit theorem, e12.11 **291**  
 generic scale invariance, 271, f12.10 **271**
- irrelevant operator, e12.8 **287**  
 leading irrelevant operator, e12.11 **293**  
 marginal operator, e12.8 **287**, e12.11 **293**  
 momentum-space,  $\epsilon$ -expansion, Monte Carlo, 269  
 near critical point, f12.12 **275**, 275–6  
 not a group, n5 **267**  
 onset of chaos, e12.9 **290**, f12.23 **290**  
 coarse-graining in time, 279  
 real-space, 269, f12.9 **270**  
 relevant operator, e12.8 **287**, e12.11 **293**  
 scaling variables, 277  
 self-organized criticality, f12.10 **271**, 272  
 stable manifold, n8 **271**  
 system space, axes for all parameters, 267  
 unstable manifold, n7 **269**
- Repressilator, e8.11 **179**
- chemical reaction network, f8.13 **181**
- Repression, of transcription by proteins, e8.11 **180**
- Response, *see* Linear response
- Restricted three-body problem, e4.4 **72**
- Reversible  
 computation, no minimum cost for, e5.3 **93**  
 engines, 78  
 all equivalent, 79
- RG, *see* Renormalization group
- $\rho$ , as sloppy notation for any probability density, n24 **42**, n32 **45**, n44 **154**
- Rigidity  
 crystal, f9.8 **196**  
 amazing, 197  
 orientational  
 liquid crystal, f9.10 **197**  
 phase gradients, in superconductors, 197  
 phase gradients, in superfluids, 197
- Risk, financial  
 avoiding with derivatives, e2.12 **32**  
 avoiding with diversification, e2.11 **32**
- RMS (Root-mean-square) distance, 16
- RNA  
 hairpin, f6.12 **127**  
 messenger, n40 **180**
- RNA polymerase  
 laser tweezer experiment, f2.9 **27**, f6.11 **126**  
 regulated by operator sites, n41 **180**
- Roads not taken by cooling glass, 83, f5.8 **85**
- Rocks  
 coarsening, 246  
 cold, cannot extract useful work from, 78  
 polyphase polycrystals, 247  
 quench rate and grain size, 247
- Root-mean-square (RMS) distance, 16
- Rotational symmetry  
 and angular momentum quantization, 306  
 broken by crystal, 192  
 broken by cube, 192  
 emergent, in lattice quantum chromodynamics, 265  
 emergent, in random walks, e2.5 **28**  
 implies matrices constant and vectors zero, n29 **207**  
 liquid, 192  
 sphere, 192
- Rotational wave, liquid crystal, f9.10 **197**
- Rotations, molecular, and free energy, n54 **56**, n31 **119**
- Roughening transition, and equilibrium crystal shape, f11.6 **247**
- Rubber band, entropy, e5.12 **98**
- $\mathbb{S}^2$ , order parameter space for magnet, 193
- $\mathbb{S}^1$ , order parameter space for Bose condensate, superfluid, superconductor, 195, e9.7 **211**
- Saddle-node bifurcation, e12.4 **283**
- Salad dressing, and coarsening, 246
- Salt  
 and dendrites, e11.9 **259**  
 lowering freezing point of water, n1 **241**, e11.9 **259**  
 osmotic pressure and high blood pressure, f5.6 **83**
- SAT, *see* Logical satisfiability
- Satisfiability, logical, *see* Logical satisfiability
- Scale invariance, 272–7  
 avalanche model  $R_c$ , f12.11 **273**  
 Ising model  $T_c$ , f12.1 **263**, f12.9 **270**, e12.1 **282**  
 leads to scaling functions, 272  
 only power laws have, n15 **275**  
 percolation  $p_c$ , n4 **267**  
 period-doubling, f12.22 **289**  
 predicted by inflation for microwave background radiation, e10.1 **232**  
 random walk, 17, f2.2 **18**  
 symmetry under change of length, 272
- Scaling  
 avalanche size distribution,  $R_c$ , 272–4  
 correction to, n2 **266**, 278, e12.2 **282**, e12.11 **293**  
 for functions of multiple variables, 276–7  
 for functions of one variable, power laws, 272–6
- Scaling collapse, 277  
 avalanche size distribution, f12.13 **276**, 277, e12.13 **297**

- liquid–gas transition, 266  
percolation finite-size scaling, e12.12 295  
small-world network separations, e1.7 11  
superconductor–insulator transition, f12.15 279
- Scaling function  
avalanche size distribution, f12.13 276, 276–7, e12.13 297  
correlation function, 277  
  coarsening, e12.3 282  
finite-size, 277, e12.12 295  
from scale invariance, 272  
magnetization, 277, e12.2 282  
normal form for bifurcations, e12.4 283  
photon number near lasing onset, e12.6 285  
superconductor–insulator transition, f12.15 279  
useful far from critical point, f12.13 276
- Scaling variable, invariant under renormalization group, 277, e12.12 295
- Scattering experiments, *see* Diffraction experiments
- Schottky anomaly, e7.10 157
- Second homotopy group, *see* Homotopy group, second
- Second law of thermodynamics: entropy increases  
  Carathéodory’s equivalent version of, 115  
  definition, 115  
  equivalent to no perpetual motion, n5 78  
  Shakespeare, and C. P. Snow, n19 115
- Second sound, superfluid, 197
- Second-order phase transitions, *see also* Continuous phase transition  
  avoid using term, n7 243  
  singularities not usually jumps in second derivative, n7 243
- Self-avoiding random walk, 19, e2.10 30
- Self-organized criticality, f12.10 271, 272
- Self-similarity, *see* Scale invariance
- Semiconductor, e7.12 157
- Sensitive dependence on initial conditions, e5.9 96
- Shakespeare, C. P. Snow, and the second law of thermodynamics, n19 115
- Shannon entropy, 87–90, e5.15 100  
  communications theory, e5.15 100  
  data compression, e5.14 100, e5.15 100  
   $k_S$  instead of  $k_B$ , 87  
   $S = -k_S \sum p \log p$ , 87  
  three key properties specify form, e5.17 102
- vs. connotations of the word ‘entropy’, n1 77
- Shot noise, of chemical concentrations in cells, e8.10 179, e8.11 181
- Shuffling, of playing cards and entropy increase, e5.13 99
- Site percolation, f2.13 35
- Site vs. bond percolation, e2.13 35, f12.7 268
- Skyrmions, classified by third homotopy group, n16 200
- Slater determinant, n16 142
- Sloppy notation  
   $g(\omega)$  and  $g(\varepsilon)$  for density of states, n32 147  
   $\rho$ , as any probability density, n24 42, n32 45, n44 154
- Slow humans, compared to atoms, 196, e9.6 209
- Slow processes  
  arise in three ways, n37 121  
  from conspiracy, 196
- Slush, formed by salt concentrating in water, n1 241, e11.9 259
- Snowflake, e11.9 259  
  as dendrite, 250  
  growth equation, e11.9 259  
  linear stability analysis, e11.9 260  
  nucleation, e11.9 259  
  picture, f11.22 260  
  tips grow fastest; less salty, humid, hot, 250, f11.21 260
- Sodium  
  and high blood pressure, f5.6 83  
  -potassium pump as Maxwell’s demon, f5.6 83
- Solar photons, random walk, e2.2 26
- Solitons and ergodicity breakdown, 68
- Sorted-list algorithm, hysteresis model, e8.14 185
- Sound  
  air, not due to broken symmetry, n6 196  
  as Goldstone mode, 196, e10.9 239  
  crystal, from broken translation invariance, f9.8 196  
  free energy density, 196  
  second, in superfluid, 197
- Sound wave, 196
- Specific heat  
  and energy fluctuations, e3.8 56, 108, e8.2 174  
  Bose, Fermi gases, f8.6 171  
  crystal, e7.11 157  
  cusp at Bose condensation  $T_c$ , f8.6 171  
  from canonical partition function, 107  
  glass, on heating and cooling, f5.18 98  
  infinite for classical continuum string, e7.11 157  
  iron, e2.9 30
- negative, black hole, e5.4 94  
  power-law singularity at critical point, 266, 275  
  string, e7.11 157  
  uniform susceptibility of energy to temperature, 226
- Sphere  
   $\mathbb{S}^0$  is  $\pm 1$ , n21 41  
   $\mathbb{S}^1$  is circle, n21 41  
   $\mathbb{S}^2$  is surface of basketball, n21 41  
  order parameter space for magnet, 193  
  unit in  $d$  dimensions called  $\mathbb{S}^{d-1}$ , n21 41  
  volume inside  $\mathbb{S}^{\ell-1}$  is  $\pi^{\ell/2} R^\ell / (\ell/2)!$ , 41
- Spherical harmonics from group representation theory, 306
- Spin  
  correlation, susceptibility, dissipation, e10.4 236  
  density matrix, time evolution, e7.6 154
- Spin glass  
  and logical satisfiability algorithms, e8.15 189  
  finding ground state NP-complete, e8.15 186  
  frustration, f12.17 280  
  replica vs. cluster models, n22 280
- Spin wave, magnetic, from broken rotational invariance, f9.9 197
- Spin-statistics theorem, n13 140
- Spinodal decomposition, spontaneous phase separation, *see* Coarsening
- Spinodal line  
  not in real systems, n10 243
- Spontaneous emission, e7.9 156  
  Einstein coefficient, e7.8 155
- Spontaneous symmetry breaking, *see* Broken symmetry
- Stability  
  fixed-point, n24 71  
  of numerical solution to dynamical system, e3.12 60
- Stable fixed point, antithesis of Liouville, e4.3 71
- Stable manifold, of renormalization group, n8 271
- Standard deviation, of probability distribution, e1.2 5
- States of matter  
  earth, water, air, fire, 191  
  multitudes, 191  
  quasicrystalline, f9.1 191  
  solid, liquid, gas, 191  
  vacuum states in early Universe, 191
- Static susceptibility, *see* Susceptibility, static
- Statistical mechanics

- equilibrium, no dynamics  
 needs Onsager's regression hypothesis, 220  
 needs quantum mechanics, 220  
 tool for deriving emergent laws, 15
- Statistics, e6.14 133  
 anyon, n12 140  
 Bose, Fermi, 140–1  
 Maxwell–Boltzmann, 53
- Statistics exercises, e6.14 133
- Statistics, overlap with statistical mechanics, 124
- Steady state, contrasted with equilibrium, n2 37
- Stefan–Boltzmann law and constant, e7.7 155, e7.15 160
- Step function, Heaviside  $\Theta(x)$ , n10 38, n28 311
- Stiff differential equations, e3.12 60
- Stimulated emission, e7.9 156  
 Einstein coefficient, e7.8 155
- Stirling's formula, 4, 53, e3.9 57, 83, e5.12 99, 110, e6.3 125  
 as asymptotic series, e1.5 7  
 average number in product, n17 40  
 derivation, e1.4 7  
 more and less accurate forms, 40
- STM image, surface pit and island evolution, f10.2 216
- Stochastic chemical reactions  
 compared to continuous, e8.10 179, e8.11 181  
 dimerization, e8.10 179  
 ensemble average, e8.10 179  
 Gillespie algorithm, e8.10 179, e8.11 180  
 repressilator, e8.11 180
- Stock price  
 and September 11, e2.11 31  
 arbitrage, e2.12 33  
 as random walk, f2.3 19, e2.11 31  
 Black–Scholes model, e2.12 32  
 derivative, e2.12 32  
 diversification and risk, e2.11 32  
 fluctuations have heavy tails, e2.11 31  
 option, e2.12 32  
 volatility, definition, e2.11 32
- Stoichiometry, of chemical reaction, n28 118, e8.10 178, e8.11 181
- Strange attractor  
 dimensions, e5.16 101  
 for Feigenbaum map at  $\mu_c$ , e5.16 101
- String theory and black-hole thermodynamics, e5.4 94
- Strong pinning boundary conditions, e9.3 205
- Subdominant correction to scaling, n2 266, 278, e12.2 282, e12.11 293
- Subject-observer design pattern, e8.13 184
- Sugar, lowering freezing point of water, n1 241
- Sun  
 photon random walk inside, e2.2 26  
 velocity of, from microwave background radiation, e10.1 232
- Sun-tan, predicted classically from oven radiation, 147
- Superconductor  
 and the renormalization group, e12.8 286  
 BCS theory, quantitative, not just adiabatic, n29 173  
 broken gauge invariance, e9.8 213  
 impossible to all orders, e12.8 286  
 Landau mean-field theory accurate for, n33 209  
 no Goldstone mode, 197  
 no more amazing than crystal, 197  
 ODLRO, 136, e9.8 211  
 why transition so cold, e12.8 286
- Superconductor–insulator transition, quantum critical properties, f12.15 279  
 scaling collapse, f12.15 279
- Supercooled vapor  
 110% humidity, n8 243  
 and dew, 244
- Superfluid  
 $\psi$  Landau order parameter,  $\phi$  topological, n39 213  
 analogy to laser, e9.7 211  
 analogy to XY model, 278  
 analogy with Bose condensate, 150, e9.7 210  
 and gregarious photons, e7.9 156  
 as superposition of states with different particle number, e9.8 213  
 Bose condensate  $\psi(r)$ , e9.7 211  
 broken gauge invariance, e9.8 213  
 circulation quantized, e9.7 211  
 coherent superposition of different number eigenstates, e9.8 213  
 density, 1% for  $\text{He}^4$ ,  $10^{-8}$  for superconductor, e9.8 213  
 Josephson current, e9.8 214  
 macroscopically occupied quantum state, e9.7 211  
 no more amazing than crystal, 197  
 number and phase as conjugate variables, e9.8 214  
 ODLRO, 136, e9.8 211  
 one-particle density matrix  $\langle a^\dagger(r')a(r) \rangle$ , e9.8 212  
 order parameter  $\psi(r)$ , 195, e9.7 211, e9.8 211  
 as condensate wavefunction, e9.7 211  
 from ODLRO, e9.8 212  
 superflow explained  
 Bose particles scatter into condensate, e7.9 156  
 winding number cannot change by one, e9.7 211  
 superposition of different particle numbers, n38 212  
 topological order parameter  $\phi(r)$  in  $S^1$ , 195, e9.7 211  
 relative phase of particle number superposition, e9.8 213  
 transition in  $\text{He}^4$   
 critical properties, f12.14 278  
 near Bose condensation temperature, 150  
 2D, nonlinear decay of superflow, n22 254  
 velocity, e9.7 211, e9.8 214  
 vortex line, topological defect, e9.7 211
- Superheated liquid, 243
- Superman, and work hardening, 200
- Supersaturated vapor, *see* Supercooled vapor
- Surface of state  $S(E, V)$ , f3.4 48
- Surface pit and island evolution, f10.2 216
- Surface tension  
 careful definition, n12 245  
 Gibbs free energy per unit area, 245, e11.3 253  
 Landau theory, e9.4 206  
 obstacle to nucleation, 245  
 power-law singularity at critical point, 275  
 rough calculation, e9.4 206, e11.3 253  
 subtle for curved surfaces, n12 245  
 traction from mean curvature  $\tau = 2\sigma\kappa$ , 248  
 van der Waals, e11.3 252
- Surface terms in free energy, e9.3 205, e9.5 207
- Susceptibility, 222–31  
 analytic in upper half-plane, 230, e10.9 240  
 and fluctuations, e8.2 174  
 $\chi(t)$  half a function,  $\tilde{\chi}(\omega)$  two functions, 229  
 damped harmonic oscillator, e10.3 235  
 equilibrium relations to correlations, 218  
 Fourier simplifies, 222  
 imaginary  $\chi''(\omega)$   
 out of phase, dissipative, 223  
 positive for  $\omega > 0$ , 224  
 linear, 222  
 polarizability, related to conductivity  $\sigma = \lim_{\omega \rightarrow 0} \omega \alpha''(\omega)$ , 224

- poles, representing damped oscillations, e10.9 240
- power-law singularity at critical point, 266, 275
- real and imaginary related by Kramers–Krönig, 229–31
- real part  $\chi'(\omega)$ , in-phase, reactive, 223
- related to correlation, fluctuation-dissipation theorem
- (classical)  $\chi''(\omega) = (\beta\omega/2)\tilde{C}(\omega)$ , 228
- (quantum)  $\chi''(\mathbf{k}, \omega) = (1/2\hbar)(1 - e^{-\beta\hbar\omega})\tilde{C}(\mathbf{k}, \omega)$ , 229
- response to external magnetic, electric, potential, 222
- sound waves, e10.9 240
- space–time response to gentle kick, 215, 222
- space–time, one-dimensional magnet, e10.8 239
- static, 224–6
- determined from equilibrium statistical mechanics, 224
  - dimple from leaning, 224
  - proportional to equal-time correlation  $\tilde{\chi}_0(\mathbf{k}) = \beta\hat{C}(\mathbf{k}, 0)$ , 225
  - related to dynamic  $\chi_0(\mathbf{r}) = \int_{-\infty}^{\infty} dt \chi(\mathbf{r}, t)$ ,  $\tilde{\chi}_0(\mathbf{k}) = \tilde{\chi}(\mathbf{k}, \omega = 0)$ , 225
  - two-state spin, e10.4 236
- two-state spin, e10.4 236
- uniform, 226
- zero for  $t < 0$  (causality), 226, 229
- Swendsen–Wang algorithm, e8.8 177
- Symmetry
- and Landau theory, e9.5 206
  - broken, *see* Broken symmetry
  - crystal vs. liquid, 192
  - cube vs. sphere, 192
  - Galilean invariance, e9.6 210
  - inversion, f9.25 210
  - restrictions on evolution laws, e9.6 210
  - restrictions on free energy density, e9.5 207
  - rotational, *see* Rotational symmetry
  - to derive wave equation, e9.6 209
  - translational, *see* Translational symmetry
- Symmetry breaking, spontaneous, *see* Broken symmetry
- Symplectic algorithm, e3.12 59
- Symplectic form, n6 64
- conserved by Verlet algorithm, n61 59
- System space, dimensions for all parameters, and renormalization group, 267
- $\mathbb{T}^2$ , order parameter space for two-dimensional crystal, 195
- $\mathbb{T}^3$ , order parameter space for three-dimensional crystal, 195
- $T$ – $\rho$  phase diagram, liquid–gas transition, f12.6 267
- Tails, heavy
- computer time for NP-complete problems, e8.15 188
  - critical droplet theory and instantons, n14 246
  - probability distribution, e8.15 188
  - stock price fluctuations, e2.11 31
- Taylor expansions
- and causality, n27 230
  - and Landau theory, e9.5 208
  - converge to nearest complex singularity, e1.5 7, 173
  - convergent inside phases, 171
- Telegraph noise, e10.5 236
- chemical concentrations in cells, e8.11 181
- definition, n53 127
- in nanojunctions, f10.16 236
  - in RNA unzipping, f6.13 127
- Temperature, 44–6
- as Lagrange multiplier, e6.6 128
  - cost of buying energy from world, 46
  - determines direction of heat flow, 44
  - equal at phase coexistence, e6.10 129, 242
  - equal when energy shifts to maximize entropy, 46, f3.3 47
  - ideal gas, 43, 52
  - intensive variable, 46
  - melting, lowered by salt or sugar, n1 241, e11.9 259
  - negative, e6.3 125
- Ternary phase diagram, for oil, water, and alcohol, f8.8 173
- Textures, classified by third homotopy group, n16 200
- Thermal activation
- and chemical equilibrium constant, 120
  - and reaction rates, 120
  - as origin of slow processes, n37 121
- Thermal conductivity
- and refrigerator efficiency, e5.6 95
  - diffusion equation, n4 16, e2.8 30
  - frying pan, e2.9 30
  - iron, e2.9 30
- Thermal de Broglie wavelength, *see* de Broglie wavelength, thermal
- Thermodynamic entropy
- and glasses, e5.11 97
  - definition, 80
  - glass, measuring residual, 84
- Thermodynamic limit, n16 114
- Thermodynamic potential, 47
- and free energy, n39 47
- Thermodynamics, 113–17
- as zoo, 115–17
  - axiomatic formulations of, 115
  - black hole, e5.4 93
  - can't win and can't break even, n21 115
  - emerges for large systems, 114
  - first law: conservation of energy, 77, 114
  - ignores fluctuations, 114, e6.7 128
  - Legendre transformation, 116
  - Nernst's theorem, 115, e7.3 153
  - no longer key in physics, v
  - not widely applicable outside physics, v
  - Oxford English dictionary definition, 114
  - second law: entropy increases, 115
  - Carathéodory's equivalent version of, 115
  - equivalent to no perpetual motion, n5 78
  - than statistical mechanics, not really trickier, 117
  - third law: entropy density zero at zero  $T$ , 115, e7.3 153
  - three laws, 114–15
  - tricky relations, 116
  - zeroth law: transitivity of equilibria, 114
- Thermodynamics exercises, e3.10 58, e3.11 58, e5.5 94, e5.6 95, e6.5 127, e6.6 128, e6.7 128, e6.8 128, e6.9 129, e6.10 129
- Third homotopy group, classifies textures, skyrmions, n16 200
- Third law of thermodynamics: entropy density zero at zero  $T$ , 115, e7.3 153
- Thought
- at heat death of Universe, 81, e5.1 91
  - cost for complex, only to record answer, n39 91, e5.3 93
- Three-body problem, e4.4 72
- KAM tori, f4.3 66
  - not equilibrating, 68
  - not ergodic, 68
  - perturbation theory fails, e4.4 73
  - Poincaré section, f4.3 66
  - vs. Newton's two-body problem, n19 68
  - why is Earth not interstellar?, 68, e4.4 73
- Three-degree cosmic background radiation, e7.15 159, e10.1 231
- Time Machine* (Wells, H. G.) and heat death of Universe, 81
- Time, arrow of, and entropy, 80
- Time–time correlation function









- general case, n12 [221](#)  
 ideal gas, Gaussian, [221](#)  
 Onsager's regression hypothesis, [222](#)
- Time-reversal invariance**  
 and detailed balance, [170](#)  
 broken by Big Bang, n30 [232](#)  
 broken in magnets, n4 [193](#)  
 correlation function, [228](#)  
 of microscopic theory, implying  
   constant entropy, [87](#), [90](#),  
   e5.7 [95](#), e7.4 [153](#)  
 vs. increasing entropy, [80](#)
- Time-time correlation function**  
 Ising model, e10.6 [237](#)  
 Onsager's regression hypothesis, [220](#)
- Topological defect**, 198–203  
 crystal dislocation, f9.11 [198](#)  
 entanglement, f9.16 [202](#), 201–3  
   only two examples, [202](#)  
 integral formula for strength, e9.2 [204](#)  
 nematic disclination, f9.14 [200](#),  
   e9.1 [203](#)  
 pair, and homotopy group  
   multiplication, [200](#), e9.2 [204](#)  
 unpatchable tear in order parameter  
   field, [198](#)
- Topology**, bending and twisting ignored,  
[199](#)
- Torus**  
 KAM, f4.7 [73](#)  
 order parameter space for crystal, [195](#)  
 periodic boundary conditions, f9.7 [195](#)  
 three-body problem, f4.7 [73](#)  
 topologically surface of donut or coffee  
   cup, e4.4 [73](#)  
 winding number around, through is  
   Burger's vector, [199](#)
- Total derivative**, [65](#)
- Total divergence terms in free energy**,  
[n38 121](#), e9.3 [205](#), e9.5 [207](#)
- Transcription**, from DNA into RNA,  
 e2.3 [26](#), n52 [126](#)  
 regulation by proteins, e8.11 [179](#)
- Transient**  
 dissipative systems, related to  
   equilibration, [65](#)  
 Hamiltonian systems, as unusual  
   states, [65](#)
- Transition state**, [120](#)  
 dividing surface, n35 [120](#)  
 theory, e6.11 [129](#)
- Translation**, from RNA into protein,  
 e2.3 [26](#)  
 regulating transcription, e8.11 [179](#)
- Translational symmetry**  
 and Fourier methods, [299](#), [305–6](#)  
 broken by crystal, [192](#), n38 [233](#)  
 broken, implies sound waves, [196](#)  
 emergent, in lattice quantum  
   chromodynamics, [265](#)
- implies conserved 'energy' for domain  
   wall structure, e9.4 [206](#)
- liquid**, [192](#)  
 not broken by two-dimensional  
   crystal, n39 [235](#)  
 to right by  $\Delta$  shifts  $x \rightarrow x - \Delta$ , n22 [23](#)
- Triple-product relation**, f3.4 [48](#), e3.10 [58](#)  
 $(\partial x / \partial y)|_f (\partial y / \partial f)|_x (\partial f / \partial x)|_y = -1$ ,  
[47](#)  
 negative of canceling fractions, n41 [47](#)
- T–V phase diagram**, liquid–gas  
 transition, f11.1 [241](#)
- Two-dimensional melting**, n39 [235](#)
- Two-phase mixture**, [242](#)  
 avoided by grand canonical ensemble,  
   n5 [242](#)  
 avoided using Gibbs free energy, [242](#)  
 interpolates between free energies;  
   convexity, f11.2 [242](#)  
 Maxwell construction, [243](#)  
 temperature, pressure,  $\mu$  equal, [242](#)
- Two-state system**, e6.2 [125](#)  
 and negative temperature, e6.3 [125](#)  
 from RNA unfolding, e6.4 [127](#)  
 in nanojunction, e10.5 [236](#)  
 model for glass, [84](#)  
 potential, f5.7 [84](#)
- Ultrasonic attenuation**, [223](#), e10.9 [240](#)
- Ultraviolet catastrophe**, and  
 equipartition theorem, [147](#)
- Uncertainty and entropy**, n26 [85](#)
- Uncertainty principle**, and Fourier  
 transform, eA.4 [308](#)
- Uncorrelated variables**, mean product is  
 product of means, n5 [17](#)
- Uncoupled systems**, canonical ensemble,  
 f6.2 [109](#), 109–11
- Undistinguished particles**  
 Gibbs factor  $1/N!$  for phase-space  
   volume, [52](#)  
 Hamiltonian and measurements treat  
   same, [52](#)  
 non-interacting, [144–6](#)  
 vs. indistinguishable particles, [52](#)
- Unit sphere in  $d$  dimensions** called  $\mathbb{S}^{d-1}$ ,  
 n21 [41](#)
- Universality**, 265–72  
 class, [266](#)  
   polymer not same as random walk,  
   [19](#), e2.10 [30](#)  
 coarsening  
   exponents dimension independent,  
   [250](#)  
   not for scaling functions, [250](#)  
   correction to scaling, n2 [266](#), [278](#),  
   e12.2 [282](#), e12.11 [293](#)  
 critical exponents, *see* **Critical**  
   exponents  
 independence of microscopic details,  
   [267](#)
- liquid–gas transition, [266](#)  
 magnetism and liquid–gas, [266](#)  
 near critical point, f12.12 [275](#), [275–6](#)  
 not for coarsening, e12.3 [282](#)  
 percolation, site vs. bond, e2.13 [35](#),  
   f12.7 [268](#)  
 period-doubling transition, [279](#),  
   e12.9 [290](#)  
 pitchfork bifurcation, e12.4 [283](#)  
 predicts much more than critical  
   exponents, [276](#)  
 random walk, [17–19](#)  
   explicit vs. renormalization-group  
   explanation, [19](#)  
 scaling functions, n44 [295](#)  
 several shared exponents, [266](#)  
 up to overall scales, f12.7 [268](#)
- Universe**  
 dominated by photons, e7.15 [160](#)  
 heat death, [81](#)  
   and life, e5.1 [91](#)  
 visible, circumference at decoupling,  
   e10.1 [233](#)
- Unreasonable effectiveness of**  
 mathematics, emergent, n1 [15](#)
- Unstable manifold**, of  
 renormalization-group fixed  
 point, n7 [269](#)
- Vacuum states in early Universe**, [191](#)
- Valence band**, e7.12 [157](#)
- van der Waals**  
 and hard sphere gas, e11.1 [252](#)  
 chemical potential, e11.3 [252](#)  
   water, f11.14 [253](#)  
 critical density, e11.2 [252](#)  
 equation of state, e11.1 [251](#)  
 fit to water, f11.13 [252](#)  
 Maxwell construction, e11.1 [251](#)  
 not quantitative for surface energy,  
   e11.3 [253](#)  
 perturbative in density, n20 [251](#)  
 surface tension, interfacial free energy,  
   e11.3 [252](#)  
 vapor pressure, e11.3 [252](#)  
 wrong critical exponent  $\beta = \frac{1}{2}$ ,  
   e11.2 [252](#)
- Variational derivative**, n41 [122](#), [196](#),  
 e9.4 [206](#), n7 [218](#), e10.8 [239](#)
- Velocity distribution**, classical, e1.2 [6](#)  
 canonical ensemble, [111](#)  
 independent of potential energy, [44](#),  
   e4.1 [70](#), [111](#)  
 microcanonical ensemble, [44](#), e4.1 [70](#)  
 vs. magnetic fields, relativity,  
   quantum, n28 [44](#)
- Verlet algorithm**: conserves symplectic  
 form, n61 [59](#)
- Very large numbers**, e3.2 [54](#)
- Vibrations**, molecular, frozen out,  
 n54 [56](#), n31 [119](#)



- Virial expansion, 172  
 van der Waals, n20 [251](#)
- Volatility  
 of index fund, smaller than stock price, e2.11 [32](#)  
 of stock price, e2.11 [32](#)
- Waiting for Godot, as Markov chain, e8.3 [175](#)
- Walls, classified by zeroth homotopy group, n16 [200](#)
- Warning  
 name  $\rho$  used everywhere for probability density, n32 [45](#)  
 use conserved currents to derive laws, n18 [21](#)
- Waste heat, 77
- Wave equation, 196  
 derived from symmetry, e9.6 [209](#)  
 for photon gas in early Universe, e7.15 [160](#)  
 quantized, e7.11 [157](#)
- Weakly-coupled systems  
 canonical ensemble, 106, f6.2 [109](#)  
 energy of one independent of state of other, 44  
 energy shell volume multiplies, e3.6 [56](#)  
 entropies add, n35 [46](#)  
 microcanonical ensemble  
 all states equal with fixed  $E_{\text{tot}}$ , 45  
 $\rho(s_1) \propto \Omega_2(E - E_1)$ , 45  
 mixture of ideal gases, e3.7 [56](#)  
 $\Omega(E) = \int dE_1 \Omega_1(E_1) \Omega_2(E - E_1)$   
 $\delta$ -function derivation, e3.6 [55](#)  
 energy-shell derivation, n31 [45](#)  
 partition function factors, 109  
 positions and momenta, n29 [45](#)  
 surface area vs. volume, n29 [45](#)  
 temperature, 44
- Weirdness of high-dimensional spaces  
 configuration space 50/50 right-hand side, 40  
 equator has most of surface area, 43  
 natural in statistical mechanics, 43
- Wells, H. G., and heat death of Universe, 81
- White dwarf  
 as Fermi gas of electrons, e7.16 [161](#)  
 stellar collapse, e7.16 [161](#)
- White noise, n11 [219](#), eA.8 [311](#)  
 $\delta$ -function correlation, 219  
 ideal gas equal-time correlation function, 219  
 zero correlation length, n9 [219](#)
- Wilkinson microwave anisotropy probe (WMAP), of cosmic microwave background radiation, f10.14 [232](#)
- Winding number  
 counts defects in XY model, e9.2 [204](#)  
 escape into third dimension, e9.1 [204](#)  
 integer, cannot change smoothly to zero, 199  
 integral formula, e9.2 [204](#)  
 KAM theorem, e4.4 [74](#)  
 nematic disclination  $\pm\frac{1}{2}$ , e9.1 [203](#)  
 not topological for nematic, e9.1 [203](#)  
 quantized circulation around superfluid vortex, e9.7 [211](#)
- Wolff algorithm, e8.8 [177](#)  
 bypasses critical slowing-down, e8.8 [177](#), e8.9 [177](#)  
 changes coarsening dynamics, e8.9 [178](#)  
 detailed balance, e8.8 [177](#)  
 ergodic, Markov, e8.8 [177](#)  
 implementation, e8.9 [177](#)  
 much faster than heat-bath, Metropolis near  $T_c$ , e8.8 [177](#), e8.9 [177](#)
- Work hardening  
 and topological defects, 200  
 magician and Superman bend bars irreversibly, 200
- $P$ - $V$  diagram  
 and Carnot cycle, f5.3 [79](#)
- Work,  $P$ - $V$  diagram, e5.5 [94](#)  
 area enclosed, 79
- Wrapping number, f9.13 [199](#)  
 counts hedgehogs, 200, e9.3 [205](#)  
 integral formula, e9.2 [205](#)
- Written works of human history, entropy of, n27 [85](#)
- Wulff construction, equilibrium crystal shape, f11.6 [247](#)
- X-ray diffraction, 217, f10.6 [218](#)  
 different from medical X-rays and CAT scans, n5 [217](#)
- XOR gate, and irreversible computation, e5.3 [93](#)
- XY model  
 analogy to superfluid, 278  
 order parameter, defects, winding number, e9.2 [204](#)
- Young measure, martensite, e11.8 [259](#)
- Zero-point energy, e7.2 [152](#), e7.15 [160](#)
- Zeroth homotopy group  
 classifies walls, n16 [200](#)
- Zeroth law of thermodynamics:  
 transitivity of equilibria, 114

<p style="text-align: center;"><b>Random walks &amp; diffusion</b></p> <p>Random walk: <math>L = \sqrt{Na} \sim N^\nu</math>, <math>\nu = \frac{1}{2}</math>, <math>d_{\text{fractal}} = 2</math>.          Self-avoiding walk: <math>\nu_{2d} = \frac{3}{4}</math>, <math>\nu_{3d} \sim 0.59</math>.          Diffusion equation:  <math display="block">\frac{\partial \rho}{\partial t} = -\nabla \cdot J = -\nabla \cdot (-D\nabla \rho + \gamma F \rho)</math> <math display="block">= D\nabla^2 \rho - \gamma F \cdot \nabla \rho \quad (D, F \text{ constant})</math> <p>Einstein relation: <math>D/\gamma = k_B T</math>          Fourier solution: <math>\tilde{\rho}_k(t) = \tilde{\rho}_k(0) \exp(-Dk^2 t)</math>          Green's function: <math>G(\mathbf{x}, t) = 1/(4\pi Dt)^{d/2} \exp[-(x^2/4Dt)]</math></p> </p>	<p style="text-align: center;"><b>Ideal Gas</b></p> <p>Thermal deBroglie wavelength: <math>\lambda = \sqrt{2\pi\hbar^2/mk_B T}</math>          Classical: <math>A = Nk_B T [\log(\rho\lambda^3) - 1]</math>,  <math>S = Nk_B (5/2 - \log(\rho\lambda^3))</math>,          Diffusive correlation function:  <math>C(\mathbf{r}, \tau) = \frac{1}{\beta\alpha} e^{-r^2/4D\tau} / (4\pi D\tau)^{3/2}</math>          Bose–Einstein: <math>\Phi^{NI} = \sum_k k_B T \log(1 - e^{-\beta(\epsilon_k - \mu)})</math>,  <math>\langle n_k \rangle = 1/(e^{\beta(\epsilon_k - \mu)} - 1)</math>          Fermi–Dirac: <math>\Xi^{NI} = \prod_k (1 + e^{-\beta(\epsilon_k - \mu)})</math>,  <math>\langle n_k \rangle = 1/(e^{\beta(\epsilon_k - \mu)} + 1)</math></p>																					
<p style="text-align: center;"><b>Entropy</b></p> <p>Thermodynamic: <math>\Delta S = Q/T = \int dQ/T = \int \frac{\delta Q}{T} dT + \frac{L}{T_c}</math>          Statistical: <math>S = k_B \log \Omega</math>      Equilibrium  <math>= k_B \log(\#\text{configs})</math>      Mixing  <math>= -k_B \sum p_i \log p_i</math>      Non-equilib  <math>= -k_B \text{Tr}(\rho \log \rho)</math>      Quantum  <math>= -k_S \sum p_i \log p_i</math>      Shannon</p>	<p style="text-align: center;"><b>Ensembles</b></p> <p>Microcanonical (3.54): <math>\Omega(E)\delta E = \int_{E &lt; \mathcal{H} &lt; E + \delta E} \frac{d\mathbb{P} d\mathcal{Q}}{h^{3N} N!}</math>          Canonical (6.5): <math>Z = \sum_n e^{-E_n/k_B T} = \text{Tr} e^{-\beta \mathcal{H}}</math>          Helmholtz free energy (6.17): <math>A = -k_B T \log Z</math>          Grand canonical (6.35): <math>\Xi = \sum_m e^{-(E_m - \mu N_m)/k_B T}</math>          Grand free energy (6.36): <math>\Phi = -k_B T \log \Xi</math>  <math>\langle O \rangle = \sum_m O_m e^{-\beta E_m} / Z = \sum_m O_m e^{-\beta(E_m - \mu N_m)} / \Xi</math></p>																					
<p><b>Thermodynamics (Section 6.4)</b></p>																						
<table style="width: 100%; border-collapse: collapse;"> <tr> <td style="width: 30%;"></td> <td style="width: 40%;"></td> <td style="width: 30%; text-align: right;">[Also known as]</td> </tr> <tr> <td>Entropy <math>S(E, V, N)</math></td> <td><math>S = E/T + PV/T - \mu N/T</math></td> <td><math>dS = dE/T + P dV/T - \mu dN/T</math></td> </tr> <tr> <td>Energy <math>E(S, V, N)</math></td> <td><math>E = TS - PV + \mu N</math></td> <td><math>dE = T dS - P dV + \mu dN</math>      U</td> </tr> <tr> <td>Helmholtz <math>A(T, V, N)</math></td> <td><math>A = E - TS = -PV + \mu N</math></td> <td><math>dA = -S dT - P dV + \mu dN</math>      F</td> </tr> <tr> <td>Grand <math>\Phi(T, V, \mu)</math></td> <td><math>\Phi = A - \mu N = -PV</math></td> <td><math>d\Phi = -S dT - P dV - N d\mu</math>      <math>\Omega, \mathcal{F}</math></td> </tr> <tr> <td>Gibbs <math>G(T, P, N)</math></td> <td><math>G = A + PV = \mu N</math></td> <td><math>dG = -S dT + V dP + \mu dN</math>      <math>\Phi</math></td> </tr> <tr> <td>Enthalpy <math>H(S, P, N)</math></td> <td><math>H = E + PV = TS + \mu N</math></td> <td><math>dH = T dS + V dP + \mu dN</math>      W</td> </tr> </table> <p>(e.g., <math>dS = \frac{1}{T} dE + \frac{P}{T} dV - \frac{\mu}{T} dN</math> means <math>(\partial S/\partial E) _{V,N} = \frac{1}{T}</math>, <math>(\partial S/\partial V) _{E,N} = \frac{P}{T}</math>, and <math>(\partial S/\partial N) _{E,V} = -\frac{\mu}{T}</math>)          A Maxwell relation (3.70): <math>(\partial T/\partial V) _{S,N} = \partial(\partial E/\partial S)/\partial V = \partial(\partial E/\partial V)/\partial S = -(\partial P/\partial S) _{V,N}</math>          A triple product relation (3.35): <math>-1 = (\partial S/\partial E) _{V,N}(\partial E/\partial V) _{S,N}(\partial V/\partial S) _{E,N} = (1/T)(-P)(T/P)</math>          Gibbs–Duhem relation (6.78): <math>S dT - V dP + N d\mu = 0</math>          Clausius–Clapeyron equation (6.79), for phase coexistence line <math>P(T)</math>: <math>dP/dT = (s_1 - s_2)/(v_1 - v_2)</math></p>				[Also known as]	Entropy $S(E, V, N)$	$S = E/T + PV/T - \mu N/T$	$dS = dE/T + P dV/T - \mu dN/T$	Energy $E(S, V, N)$	$E = TS - PV + \mu N$	$dE = T dS - P dV + \mu dN$ U	Helmholtz $A(T, V, N)$	$A = E - TS = -PV + \mu N$	$dA = -S dT - P dV + \mu dN$ F	Grand $\Phi(T, V, \mu)$	$\Phi = A - \mu N = -PV$	$d\Phi = -S dT - P dV - N d\mu$ $\Omega, \mathcal{F}$	Gibbs $G(T, P, N)$	$G = A + PV = \mu N$	$dG = -S dT + V dP + \mu dN$ $\Phi$	Enthalpy $H(S, P, N)$	$H = E + PV = TS + \mu N$	$dH = T dS + V dP + \mu dN$ W
		[Also known as]																				
Entropy $S(E, V, N)$	$S = E/T + PV/T - \mu N/T$	$dS = dE/T + P dV/T - \mu dN/T$																				
Energy $E(S, V, N)$	$E = TS - PV + \mu N$	$dE = T dS - P dV + \mu dN$ U																				
Helmholtz $A(T, V, N)$	$A = E - TS = -PV + \mu N$	$dA = -S dT - P dV + \mu dN$ F																				
Grand $\Phi(T, V, \mu)$	$\Phi = A - \mu N = -PV$	$d\Phi = -S dT - P dV - N d\mu$ $\Omega, \mathcal{F}$																				
Gibbs $G(T, P, N)$	$G = A + PV = \mu N$	$dG = -S dT + V dP + \mu dN$ $\Phi$																				
Enthalpy $H(S, P, N)$	$H = E + PV = TS + \mu N$	$dH = T dS + V dP + \mu dN$ W																				
<p style="text-align: center;"><b>Harmonic oscillator</b></p> <p>Classical: <math>A = k_B T \log(\hbar\omega/k_B T)</math>, equipartition theorem <math>\frac{1}{2}k_B T</math> per degree of freedom          Quantum: <math>Z = 1/[\exp(\beta\hbar\omega/2) - \exp(-\beta\hbar\omega/2)]</math></p>																						

### Order parameters, topological defects (Chapter 9)

System	Order parameter	Defect	Homotopy	
Crystal		Torus $\mathbb{T}^d$	Dislocation 	$\Pi_1(\mathbb{T}^d) = \mathbb{Z}^d$
Magnet		Sphere $\mathbb{S}^2$	Hedgehog 	$\Pi_2(\mathbb{S}^2) = \mathbb{Z}$
Nematic		Hemisphere $\mathbb{R}P^2$	Disclination 	$\Pi_1(\mathbb{R}P^2) = \mathbb{Z}_2$
Superfluid/conductor		Circle $\mathbb{S}^1$	Vortex Line 	$\Pi_1(\mathbb{S}^1) = \mathbb{Z}$

### Correlation, response, dissipation (Chapter 10)

Correlation function:  $C(\mathbf{r}, \tau) = \langle s(\mathbf{x}, t)s(\mathbf{x} + \mathbf{r}, t + \tau) \rangle$

Scattering experiments:  $\tilde{C}(\mathbf{k}, 0) \propto |\tilde{s}(\mathbf{k})|^2$

Onsager's regression hypothesis: (Green's function  $G$ ):

$$\tilde{C}(\mathbf{k}, \tau) = \tilde{G}(\mathbf{k}, \tau)\tilde{C}(\mathbf{k}, 0)$$

Susceptibility to force field  $f(\mathbf{x}, t)$ :

$$s(\mathbf{x}, t) = \int d\mathbf{x}' \int_{-\infty}^t dt' \chi(\mathbf{x} - \mathbf{x}', t - t') f(\mathbf{x}', t')$$

$$\tilde{s}(\mathbf{k}, \omega) = \tilde{\chi}(\mathbf{k}, \omega) f(\mathbf{k}, \omega) = (\chi'(\mathbf{k}, \omega) + i\chi''(\mathbf{k}, \omega)) \tilde{f}(\mathbf{k}, \omega)$$

Power dissipated:  $p(\omega) = (\omega |\tilde{f}(\omega)|^2 / 2) \chi''(\omega)$

Static susceptibility:  $\chi_0(\mathbf{r}) = \int_{-\infty}^{\infty} dt \chi(\mathbf{r}, t)$

Causality:  $\chi(t) = 0, t < 0$

Fluctuation-response theorem:  $\chi_0(\mathbf{r}) = \beta C(\mathbf{r}, 0)$

Macroscopic fluctuations vanish:

$$\langle \langle s \rangle_{\text{space}}^2 \rangle = k_B T \chi_0(\mathbf{0}) / V \rightarrow 0 \text{ as } V \rightarrow \infty.$$

Fluctuation-dissipation theorem:

(classical)  $\chi(\mathbf{x}, t) = -\beta \partial C(\mathbf{x}, t) / \partial t \quad (t > 0)$ ,

$$\chi''(\mathbf{k}, \omega) = (\beta\omega/2)\tilde{C}(\omega)$$

(quantum)  $\chi''(\mathbf{k}, \omega) = (1/2\hbar) (1 - e^{\beta\hbar\omega}) \tilde{C}(\omega)$

Dissipated power:  $p(\omega) = (\beta\omega^2/4) |\tilde{f}_\omega|^2 \tilde{C}(\mathbf{k}, \omega)$

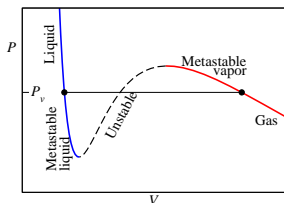
Kramers-Krönig (causality):

$$\tilde{\chi}(\omega) = (1/\pi i) \int d\omega' \tilde{\chi}(\omega') / (\omega' - \omega)$$

$$\chi'(\omega) = (2/\pi) \int_0^\infty d\omega' \omega' \chi''(\omega') / (\omega'^2 - \omega^2)$$

$$\chi''(\omega) = -(2\omega/\pi) \int_0^\infty d\omega' \chi'(\omega') / (\omega'^2 - \omega^2)$$

### Abrupt phase transitions (Chapter 11)



Equal area construction

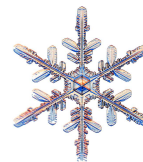
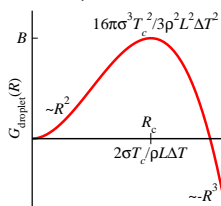
Nucleation theory

$$\Gamma = \Gamma_0 e^{-B/k_B T}$$

Coarsening,  $L(t) \sim t^\beta$

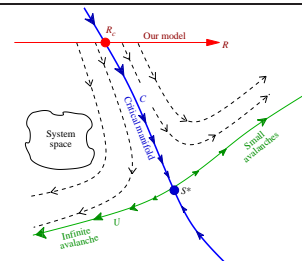
$\beta = 1/2$  /  $1/3$ , un/conserved

Dendrites, martensites



©2003 Libbrecht [80]

### Continuous phase transitions (Chapter 12)



Coarse-graining, scaling

Renormalization group

Universal critical exponents  $\beta, \nu, \dots$

Scaling functions  $\mathcal{D}, \mathcal{M}, \mathcal{C}, \dots$

$$D(S, R) \sim S^{-\tau} \mathcal{D}(S^\sigma (R - R_c))$$

