

Contents

- Contents** **i**

- List of Figures** **ii**

- List of Tables** **ii**

- 2 Linear Oscillations** **1**

 - 2.1 Harmonic Motion 1
 - 2.2 Damped Harmonic Oscillator 1
 - 2.2.1 Classes of damped harmonic motion 2
 - 2.2.2 Remarks on the case of critical damping 4
 - 2.2.3 Phase portraits for the damped harmonic oscillator 5
 - 2.3 Damped Harmonic Oscillator with Forcing 6
 - 2.3.1 Resonant forcing 9
 - 2.3.2 $R-L-C$ circuits 9
 - 2.3.3 Examples 10
 - 2.4 General Solution by Green's Function Method 13
 - 2.5 General Linear Autonomous Inhomogeneous ODEs 15

2.6	Kramers-Krönig Relations	18
-----	------------------------------------	----

List of Figures

2.1	Three classifications of damped harmonic motion	3
2.2	Phase curves for the damped harmonic oscillator	5
2.3	Amplitude and phase shift <i>versus</i> oscillator frequency	7
2.4	An R - L - C circuit which behaves as a damped harmonic oscillator	10
2.5	A driven L - C - R circuit, with $V(t) = V_0 \cos(\omega t)$	12
2.6	The equivalent mechanical circuit for fig. 2.5	12
2.7	Response of an underdamped oscillator to a pulse force	14

List of Tables

Chapter 2

Linear Oscillations

2.1 Harmonic Motion

Harmonic motion is ubiquitous in physics. The reason is that any potential energy function, when expanded in a Taylor series in the vicinity of a local minimum, is a harmonic function:

$$U(q) = U(q^*) + \sum_{j=1}^N \overbrace{\frac{\partial U}{\partial q_j} \Big|_{q=q^*}}^{\nabla U(q^*)=0} (q_j - q_j^*) + \frac{1}{2} \sum_{j,k=1}^N \frac{\partial^2 U}{\partial q_j \partial q_k} \Big|_{q=q^*} (q_j - q_j^*) (q_k - q_k^*) + \dots \quad , \quad (2.1)$$

where $q = \{q_1, \dots, q_N\}$ are the *generalized coordinates* of a system of point particles – more on this when we discuss Lagrangians. In one dimension, we have one coordinate, which we shall call x , and we expand the potential $U(x)$ about an extremum using Taylor's theorem, *viz.*

$$U(x) = U(x^*) + \frac{1}{2} U''(x^*) (x - x^*)^2 + \dots \quad . \quad (2.2)$$

Provided the deviation $\eta = x - x^*$ is small enough in magnitude, the remaining terms in the Taylor expansion may be ignored. Newton's Second Law then gives

$$m \ddot{\eta} = -U''(x^*) \eta + \mathcal{O}(\eta^2) \quad . \quad (2.3)$$

This, to lowest order, is the equation of motion for a harmonic oscillator. If $U''(x^*) > 0$, the equilibrium point $x = x^*$ is *stable*, since for small deviations from equilibrium the restoring force pushes the system back toward the equilibrium point. When $U''(x^*) < 0$, the equilibrium is *unstable*, and the forces push one further away from equilibrium.

2.2 Damped Harmonic Oscillator

In the real world, there are frictional forces, which we here will approximate by $F = -\gamma v$. We begin with the homogeneous equation for a damped harmonic oscillator,

$$\frac{d^2x}{dt^2} + 2\beta \frac{dx}{dt} + \omega_0^2 x = 0 \quad , \quad (2.4)$$

where $\gamma = 2\beta m$. To solve, write $x(t) = \sum_n C_n e^{-i\omega_n t}$. This renders the differential equation 2.4 an *algebraic* equation for the two eigenfrequencies ω_i , each of which must satisfy

$$\omega^2 + 2i\beta\omega - \omega_0^2 = 0 \quad , \quad (2.5)$$

hence

$$\omega_{\pm} = -i\beta \pm (\omega_0^2 - \beta^2)^{1/2} \quad . \quad (2.6)$$

The most general solution to eqn. 2.4 is then

$$x(t) = C_+ e^{-i\omega_+ t} + C_- e^{-i\omega_- t} \quad (2.7)$$

where C_{\pm} are arbitrary constants. Notice that the eigenfrequencies are in general complex, with a negative imaginary part (so long as the damping coefficient β is positive). Thus $e^{-i\omega_{\pm} t}$ decays to zero as $t \rightarrow \infty$.

2.2.1 Classes of damped harmonic motion

We identify three classes of motion:

Underdamped motion ($\omega_0^2 > \beta^2$)

The solution for underdamped motion is

$$\begin{aligned} x(t) &= A \cos(\nu t) e^{-\beta t} + B \sin(\nu t) e^{-\beta t} \\ \dot{x}(t) &= (-\beta A + \nu B) \cos(\nu t) e^{-\beta t} - (\nu A + \beta B) \sin(\nu t) e^{-\beta t} \quad , \end{aligned} \quad (2.8)$$

where $\nu = \sqrt{\omega_0^2 - \beta^2}$, and where A and B are constants determined by initial conditions,

$$x_0 = A \quad , \quad \dot{x}_0 = -\beta A + \nu B \quad .$$

Simultaneously solving these two equations in the two unknowns yields

$$A = x_0 \quad , \quad B = \frac{\beta}{\nu} x_0 + \frac{1}{\nu} \dot{x}_0 \quad . \quad (2.9)$$

Overdamped motion ($\omega_0^2 < \beta^2$)

The solution in the case of overdamped motion is

$$\begin{aligned} x(t) &= C \cosh(\lambda t) e^{-\beta t} + D \sinh(\lambda t) e^{-\beta t} \\ \dot{x}(t) &= (-\beta C + \lambda D) \cosh(\lambda t) e^{-\beta t} + (\lambda C - \beta D) \sinh(\lambda t) e^{-\beta t} \quad , \end{aligned} \quad (2.10)$$

where $\lambda = \sqrt{\beta^2 - \omega_0^2}$ and where C and D are constants determined by the initial conditions

$$x_0 = C \quad , \quad \dot{x}_0 = -\beta C + \lambda D \quad . \quad (2.11)$$

Solving for the two unknowns, we have

$$C = x_0 \quad , \quad D = \frac{\beta}{\lambda} x_0 + \frac{1}{\lambda} \dot{x}_0 \quad . \quad (2.12)$$

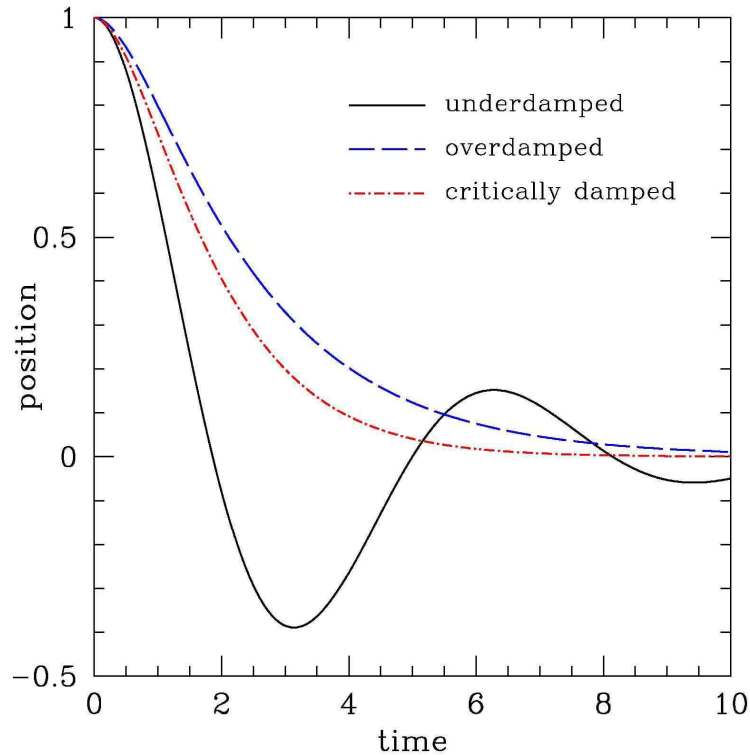

Figure 2.1: Three classifications of damped harmonic motion. The initial conditions are $x(0) = 1$, $\dot{x}(0) = 0$.

Critically damped motion ($\omega_0^2 = \beta^2$)

The solution in the case of critically damped motion is

$$\begin{aligned} x(t) &= E e^{-\beta t} + F t e^{-\beta t} \\ \dot{x}(t) &= (-\beta E + F) e^{-\beta t} - \beta F t e^{-\beta t} \end{aligned} \quad (2.13)$$

Thus, $x_0 = E$ and $\dot{x}_0 = -\beta E + F$, and

$$E = x_0 \quad , \quad F = \dot{x}_0 + \beta x_0 \quad . \quad (2.14)$$

The screen door analogy

The three types of behavior are depicted in fig. 2.1. To concretize these cases in one's mind, it is helpful to think of the case of a screen door or a shock absorber. If the hinges on the door are underdamped, the door will swing back and forth (assuming it doesn't have a rim which smacks into the door frame) several times before coming to a stop. If the hinges are overdamped, the door may take a very long time

to close. To see this, note that for $\beta \gg \omega_0$ we have

$$\sqrt{\beta^2 - \omega_0^2} = \beta \left(1 - \frac{\omega_0^2}{\beta^2}\right)^{1/2} = \beta - \frac{\omega_0^2}{2\beta} - \frac{\omega_0^4}{8\beta^3} + \dots \quad , \quad (2.15)$$

which leads to

$$\begin{aligned} i\omega_+ &= \beta - \sqrt{\beta^2 - \omega_0^2} = \frac{\omega_0^2}{2\beta} + \frac{\omega_0^4}{8\beta^3} + \dots \\ i\omega_- &= \beta + \sqrt{\beta^2 - \omega_0^2} = 2\beta - \frac{\omega_0^2}{2\beta} - \dots \quad . \end{aligned} \quad (2.16)$$

Thus, we can write

$$x(t) = C e^{-t/\tau_1} + D e^{-t/\tau_2} \quad , \quad (2.17)$$

with

$$\tau_1 = \frac{1}{\beta - \sqrt{\beta^2 - \omega_0^2}} \approx \frac{2\beta}{\omega_0^2} \quad , \quad \tau_2 = \frac{1}{\beta + \sqrt{\beta^2 - \omega_0^2}} \approx \frac{1}{2\beta} \quad . \quad (2.18)$$

Thus $x(t)$ is a sum of exponentials, with decay times $\tau_{1,2}$. For $\beta \gg \omega_0$, we have that τ_1 is much larger than τ_2 – the ratio is $\tau_1/\tau_2 \approx 4\beta^2/\omega_0^2 \gg 1$. Thus, on time scales on the order of τ_1 , the second term has completely damped away. The decay time τ_1 , though, is very long, since β is so large. So a highly overdamped oscillator will take a very long time to come to equilibrium.

2.2.2 Remarks on the case of critical damping

Define the first order differential operator

$$\mathcal{D}_t = \frac{d}{dt} + \beta \quad . \quad (2.19)$$

The solution to $\mathcal{D}_t x(t) = 0$ is $\tilde{x}(t) = A e^{-\beta t}$, where A is a constant. Note that the *commutator* of \mathcal{D}_t and t is unity:

$$[\mathcal{D}_t, t] = 1 \quad , \quad (2.20)$$

where $[A, B] \equiv AB - BA$. The simplest way to verify eqn. 2.20 is to compute its action upon an arbitrary function $f(t)$:

$$\begin{aligned} [\mathcal{D}_t, t] f(t) &= \left(\frac{d}{dt} + \beta\right) t f(t) - t \left(\frac{d}{dt} + \beta\right) f(t) \\ &= \frac{d}{dt}(t f(t)) - t \frac{d}{dt} f(t) = f(t) \quad . \end{aligned} \quad (2.21)$$

We know that $x(t) = \tilde{x}(t) = A e^{-\beta t}$ satisfies $\mathcal{D}_t x(t) = 0$. Therefore

$$\begin{aligned} 0 &= \mathcal{D}_t [\mathcal{D}_t, t] \tilde{x}(t) \\ &= \mathcal{D}_t^2 (t \tilde{x}(t)) - \mathcal{D}_t t \overbrace{\mathcal{D}_t \tilde{x}(t)}^0 = \mathcal{D}_t^2 (t \tilde{x}(t)) \quad . \end{aligned} \quad (2.22)$$

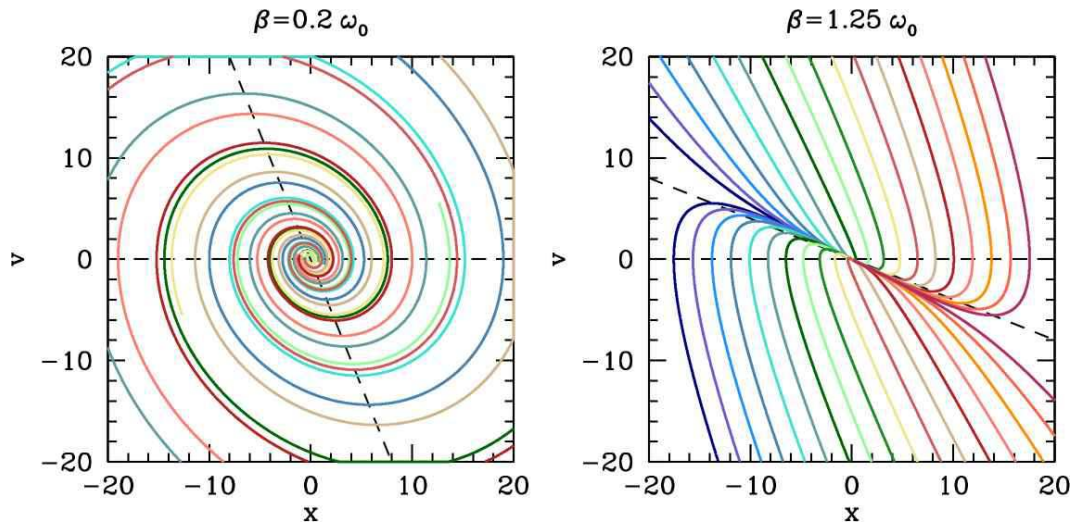

Figure 2.2: Phase curves for the damped harmonic oscillator. Left panel: underdamped motion. Right panel: overdamped motion. Note the *nullclines* along $v = 0$ and $v = -(\omega_0^2/2\beta)x$, which are shown as dashed lines.

We already know that $\mathcal{D}_t^2 \tilde{x}(t) = \mathcal{D}_t \mathcal{D}_t \tilde{x}(t) = 0$. The above equation establishes that the second independent solution to the second order ODE $\mathcal{D}_t^2 x(t) = 0$ is $x(t) = t \tilde{x}(t)$. Indeed, we can keep going, and show that

$$\mathcal{D}_t^n \left(t^{n-1} \tilde{x}(t) \right) = 0 \quad . \quad (2.23)$$

Thus, the n independent solutions to the n^{th} order ODE

$$\left(\frac{d}{dt} + \beta \right)^n x(t) = 0 \quad (2.24)$$

are

$$x_k(t) = A t^k e^{-\beta t} \quad , \quad k = 0, 1, \dots, n-1 \quad . \quad (2.25)$$

2.2.3 Phase portraits for the damped harmonic oscillator

Expressed as a dynamical system, the equation of motion $\ddot{x} + 2\beta\dot{x} + \omega_0^2 x = 0$ is written as two coupled first order ODEs, *viz.*

$$\begin{aligned} \dot{x} &= v \\ \dot{v} &= -\omega_0^2 x - 2\beta v \quad . \end{aligned} \quad (2.26)$$

In the theory of dynamical systems, a *nullcline* is a curve along which one component of the phase space velocity $\dot{\varphi}$ vanishes. In our case, there are two nullclines: $\dot{x} = 0$ and $\dot{v} = 0$. The equation of the first nullcline, $\dot{x} = 0$, is simply $v = 0$, *i.e.* the first nullcline is the x -axis. The equation of the second nullcline, $\dot{v} = 0$, is $v = -(\omega_0^2/2\beta)x$. This is a line which runs through the origin and has negative slope. Everywhere along the first nullcline $\dot{x} = 0$, we have that $\dot{\varphi}$ lies parallel to the v -axis. Similarly, everywhere along the second nullcline $\dot{v} = 0$, we have that $\dot{\varphi}$ lies parallel to the x -axis. The situation is depicted in fig. 2.2.

2.3 Damped Harmonic Oscillator with Forcing

When forced, the equation for the damped oscillator becomes

$$\frac{d^2x}{dt^2} + 2\beta \frac{dx}{dt} + \omega_0^2 x = f(t) \quad , \quad (2.27)$$

where $f(t) = F(t)/m$. Since this equation is linear in $x(t)$, we can, without loss of generality, restrict our attention to harmonic forcing terms of the form

$$f(t) = f_0 \cos(\Omega t + \varphi_0) = \operatorname{Re} \left[f_0 e^{-i\varphi_0} e^{-i\Omega t} \right] \quad (2.28)$$

where Re stands for “real part”. Here, Ω is the forcing frequency.

Consider first the complex equation

$$\frac{d^2z}{dt^2} + 2\beta \frac{dz}{dt} + \omega_0^2 z = f_0 e^{-i\varphi_0} e^{-i\Omega t} \quad . \quad (2.29)$$

We try a solution $z(t) = z_0 e^{-i\Omega t}$. Plugging in, we obtain the algebraic equation

$$z_0 = \frac{f_0 e^{-i\varphi_0}}{\omega_0^2 - 2i\beta\Omega - \Omega^2} \equiv A(\Omega) e^{i\delta(\Omega)} f_0 e^{-i\varphi_0} \quad . \quad (2.30)$$

The amplitude $A(\Omega)$ and phase shift $\delta(\Omega)$ are given by the equation

$$A(\Omega) e^{i\delta(\Omega)} = \frac{1}{\omega_0^2 - 2i\beta\Omega - \Omega^2} \quad . \quad (2.31)$$

A basic fact of complex numbers:

$$\frac{1}{a - ib} = \frac{a + ib}{a^2 + b^2} = \frac{e^{i \tan^{-1}(b/a)}}{\sqrt{a^2 + b^2}} \quad . \quad (2.32)$$

Thus,

$$A(\Omega) = \left((\omega_0^2 - \Omega^2)^2 + 4\beta^2\Omega^2 \right)^{-1/2} \quad , \quad \delta(\Omega) = \tan^{-1} \left(\frac{2\beta\Omega}{\omega_0^2 - \Omega^2} \right) \quad . \quad (2.33)$$

Now since the coefficients β and ω_0^2 are real, we can take the complex conjugate of eqn. 2.29, and write

$$\begin{aligned} \ddot{z} + 2\beta \dot{z} + \omega_0^2 z &= f_0 e^{-i\varphi_0} e^{-i\Omega t} \\ \ddot{\bar{z}} + 2\beta \dot{\bar{z}} + \omega_0^2 \bar{z} &= f_0 e^{+i\varphi_0} e^{+i\Omega t} \quad , \end{aligned} \quad (2.34)$$

where \bar{z} is the complex conjugate of z . We now add these two equations and divide by two to arrive at

$$\ddot{x} + 2\beta \dot{x} + \omega_0^2 x = f_0 \cos(\Omega t + \varphi_0) \quad . \quad (2.35)$$

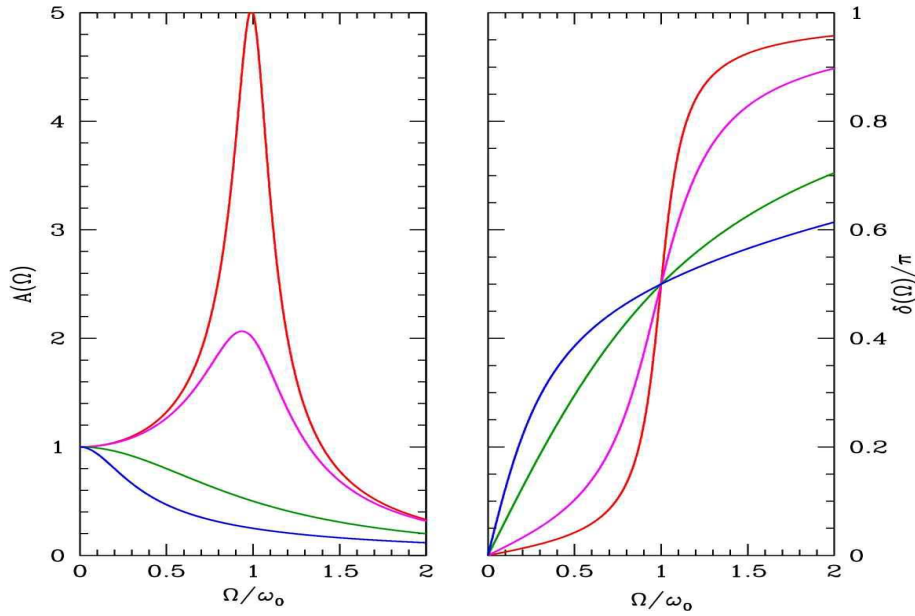

Figure 2.3: Amplitude and phase shift *versus* oscillator frequency (units of ω_0) for β/ω_0 values of 0.1 (red), 0.25 (magenta), 1.0 (green), and 2.0 (blue).

Therefore, the real, physical solution we seek is

$$\begin{aligned} x_{\text{inh}}(t) &= \text{Re} \left[A(\Omega) e^{i\delta(\Omega)} \cdot f_0 e^{-i\varphi_0} e^{-i\Omega t} \right] \\ &= A(\Omega) f_0 \cos(\Omega t + \varphi_0 - \delta(\Omega)) \quad . \end{aligned} \quad (2.36)$$

The quantity $A(\Omega)$ is the *amplitude* of the response (in units of f_0), while $\delta(\Omega)$ is the (dimensionless) *phase lag* (typically expressed in radians).

The maximum of the amplitude $A(\Omega)$ occurs when $A'(\Omega) = 0$. From

$$\frac{dA}{d\Omega} = -\frac{2\Omega}{[A(\Omega)]^3} (\Omega^2 - \omega_0^2 + 2\beta^2) \quad , \quad (2.37)$$

we conclude that $A'(\Omega) = 0$ for $\Omega = 0$ and for $\Omega = \Omega_R$, where

$$\Omega_R = \sqrt{\omega_0^2 - 2\beta^2} \quad . \quad (2.38)$$

The solution at $\Omega = \Omega_R$ pertains only if $\omega_0^2 > 2\beta^2$, of course, in which case $\Omega = 0$ is a local minimum and $\Omega = \Omega_R$ a local maximum. If $\omega_0^2 < 2\beta^2$ there is only a local maximum, at $\Omega = 0$. See fig. 2.3.

Since equation 2.27 is linear, we can add a solution to the homogeneous equation to $x_{\text{inh}}(t)$ and we will still have a solution. Thus, the most general solution to eqn. 2.27 is Therefore, the real, physical solution

we seek is

$$\begin{aligned}
 x(t) &= x_{\text{inh}}(t) + x_{\text{hom}}(t) \\
 &= \text{Re} \left[A(\Omega) e^{i\delta(\Omega)} \cdot f_0 e^{-i\varphi_0} e^{-i\Omega t} \right] + C_+ e^{-i\omega_+ t} + C_- e^{-i\omega_- t} \\
 &= \underbrace{A(\Omega) f_0 \cos(\Omega t + \varphi_0 - \delta(\Omega))}_{x_{\text{inh}}(t)} + \underbrace{\begin{cases} C e^{-\beta t} \cos(\nu t) + D e^{-\beta t} \sin(\nu t) \\ C e^{-\beta t} \cosh(\lambda t) + D e^{-\beta t} \sinh(\lambda t) \end{cases}}_{x_{\text{hom}}(t)} .
 \end{aligned} \tag{2.39}$$

When $\omega_0^2 > \beta^2$, we choose the top expression for $x_{\text{hom}}(t)$, with $\nu = \sqrt{\omega_0^2 - \beta^2}$. When $\omega^2 < \beta^2$, we choose the bottom expression for $x_{\text{hom}}(t)$, with $\lambda = \sqrt{\beta^2 - \omega_0^2}$.

The quantity $x_{\text{hom}}(t)$ in eqn. 2.39 is the solution to the homogeneous equation, *i.e.* with $f(t) = 0$. This involves two constants of integration, C and D , which are then determined by imposing initial conditions on $x(0)$ and $\dot{x}(0)$ – two constants of integration always arise in the solution of a second order ODE, whether or not it is homogeneous. That is, C and D are adjusted so as to satisfy $x(0) = x_0$ and $\dot{x}_0 = v_0$. However, due to their $e^{-\beta t}$ prefactor, these terms decay to zero once t reaches a relatively low multiple of β^{-1} . They are called *transients*, and may be set to zero if we are only interested in the long time behavior of the system. This means, incidentally, that the initial conditions are effectively forgotten over a time scale on the order of β^{-1} .

For $\Omega_{\text{R}} > 0$, one defines the *quality factor*, Q , of the oscillator by $Q = \Omega_{\text{R}}/2\beta$. Q is a rough measure of how many periods the unforced oscillator executes before its initial amplitude is damped down to a small value. For a forced oscillator driven near resonance, and for weak damping, Q is also related to the ratio of average energy in the oscillator to the energy lost per cycle by the external source. To see this, let us compute the energy lost per cycle,

$$\begin{aligned}
 \Delta E &= m \int_0^{2\pi/\Omega} dt \dot{x} f(t) \\
 &= -m \int_0^{2\pi/\Omega} dt \Omega A f_0^2 \sin(\Omega t + \varphi_0 - \delta) \cos(\Omega t + \varphi_0) \\
 &= \pi A f_0^2 m \sin \delta = 2\pi\beta m \Omega A^2(\Omega) f_0^2 ,
 \end{aligned} \tag{2.40}$$

since $\sin \delta(\Omega) = 2\beta\Omega A(\Omega)$. The oscillator energy, averaged over the cycle, is

$$\langle E \rangle = \frac{\Omega}{2\pi} \int_0^{2\pi/\Omega} dt \frac{1}{2} m (\dot{x}^2 + \omega_0^2 x^2) = \frac{1}{4} m (\Omega^2 + \omega_0^2) A^2(\Omega) f_0^2 . \tag{2.41}$$

Thus, we have

$$\frac{2\pi \langle E \rangle}{\Delta E} = \frac{\Omega^2 + \omega_0^2}{4\beta\Omega} . \tag{2.42}$$

Thus, for $\Omega \approx \Omega_{\text{R}}$ and $\beta^2 \ll \omega_0^2$, we have

$$Q \approx \frac{2\pi \langle E \rangle}{\Delta E} \approx \frac{\omega_0}{2\beta} . \tag{2.43}$$

2.3.1 Resonant forcing

When the damping β vanishes, the response diverges at resonance. The solution to the resonantly forced oscillator

$$\ddot{x} + \omega_0^2 x = f_0 \cos(\omega_0 t + \varphi_0) \quad (2.44)$$

is given by

$$x(t) = \frac{f_0}{2\omega_0} t \sin(\omega_0 t + \varphi_0) + \overbrace{A \cos(\omega_0 t) + B \sin(\omega_0 t)}^{x_{\text{hom}}(t)} \quad (2.45)$$

The amplitude of this solution grows linearly due to the energy pumped into the oscillator by the resonant external forcing. In the real world, nonlinearities can mitigate this unphysical, unbounded response.

2.3.2 R-L-C circuits

Consider the R-L-C circuit of fig. 2.4. When the switch is to the left, the capacitor is charged, eventually to a steady state value $Q = CV$. At $t = 0$ the switch is thrown to the right, completing the R-L-C circuit. Recall that the sum of the voltage drops across the three elements must be zero:

$$L \frac{dI}{dt} + IR + \frac{Q}{C} = 0 \quad (2.46)$$

We also have $\dot{Q} = I$, hence

$$\frac{d^2 Q}{dt^2} + \frac{R}{L} \frac{dQ}{dt} + \frac{1}{LC} Q = 0 \quad (2.47)$$

which is the equation for a damped harmonic oscillator, with $\omega_0 = (LC)^{-1/2}$ and $\beta = R/2L$.

The boundary conditions at $t = 0$ are $Q(0) = CV$ and $\dot{Q}(0) = 0$. Under these conditions, the full solution at all times is

$$\begin{aligned} Q(t) &= CV e^{-\beta t} \left(\cos \nu t + \frac{\beta}{\nu} \sin \nu t \right) \\ I(t) &= -CV \frac{\omega_0^2}{\nu} e^{-\beta t} \sin \nu t \quad (2.48) \end{aligned}$$

again with $\nu = \sqrt{\omega_0^2 - \beta^2}$.

If we put a time-dependent voltage source in series with the resistor, capacitor, and inductor, we would have

$$L \frac{dI}{dt} + IR + \frac{Q}{C} = V(t) \quad (2.49)$$

which is the equation of a *forced* damped harmonic oscillator.

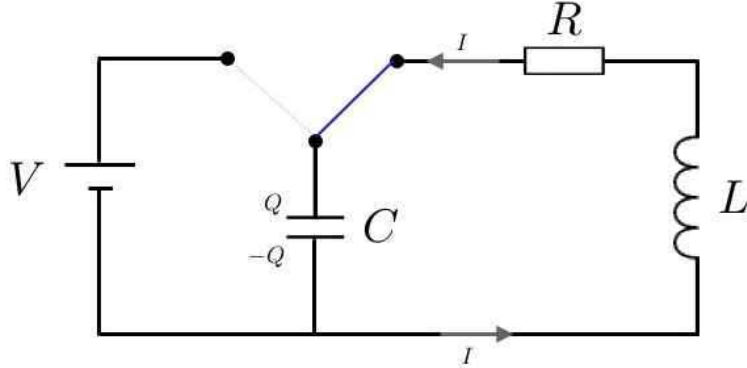

Figure 2.4: An R - L - C circuit which behaves as a damped harmonic oscillator.

2.3.3 Examples

Third order linear ODE with forcing

The problem is to solve the equation

$$\mathcal{L}_t x \equiv \ddot{x} + (a + b + c) \dot{x} + (ab + ac + bc) x + abc x = f_0 \cos(\Omega t) \quad . \quad (2.50)$$

The key to solving this is to note that the differential operator \mathcal{L}_t factorizes:

$$\begin{aligned} \mathcal{L}_t &= \frac{d^3}{dt^3} + (a + b + c) \frac{d^2}{dt^2} + (ab + ac + bc) \frac{d}{dt} + abc \\ &= \left(\frac{d}{dt} + a \right) \left(\frac{d}{dt} + b \right) \left(\frac{d}{dt} + c \right) \quad , \end{aligned} \quad (2.51)$$

which says that the third order differential operator appearing in the ODE is in fact a product of first order differential operators. Since

$$\frac{dx}{dt} + \alpha x = 0 \quad \implies \quad x(t) = A e^{-\alpha t} \quad , \quad (2.52)$$

we see that the homogeneous solution takes the form

$$x_h(t) = A e^{-at} + B e^{-bt} + C e^{-ct} \quad , \quad (2.53)$$

where A , B , and C are constants.

To find the inhomogeneous solution, we solve $\mathcal{L}_t x = f_0 e^{-i\Omega t}$ and take the real part. As before, we assume the inhomogeneous solution $x(t)$ oscillates with the driving frequency Ω , and we write $x(t) = x_0 e^{-i\Omega t}$, which entails

$$\mathcal{L}_t x_0 e^{-i\Omega t} = (a - i\Omega)(b - i\Omega)(c - i\Omega) x_0 e^{-i\Omega t} \quad (2.54)$$

and thus

$$x_0 = \frac{f_0 e^{-i\Omega t}}{(a - i\Omega)(b - i\Omega)(c - i\Omega)} \equiv A(\Omega) e^{i\delta(\Omega)} f_0 e^{-i\Omega t} \quad ,$$

where

$$\begin{aligned} A(\Omega) &= \left[(a^2 + \Omega^2) (b^2 + \Omega^2) (c^2 + \Omega^2) \right]^{-1/2} \\ \delta(\Omega) &= \tan^{-1} \left(\frac{\Omega}{a} \right) + \tan^{-1} \left(\frac{\Omega}{b} \right) + \tan^{-1} \left(\frac{\Omega}{c} \right) . \end{aligned} \quad (2.55)$$

Thus, the most general solution to $L_t x(t) = f_0 \cos(\Omega t)$ is

$$x(t) = A(\Omega) f_0 \cos(\Omega t - \delta(\Omega)) + A e^{-at} + B e^{-bt} + C e^{-ct} . \quad (2.56)$$

Note that the phase shift increases monotonically from $\delta(0) = 0$ to $\delta(\infty) = \frac{3}{2}\pi$.

Mechanical analog of RLC circuit

Consider the electrical circuit in fig. 2.5. Our task is to construct its mechanical analog. To do so, we invoke Kirchoff's laws around the left and right loops:

$$\begin{aligned} L_1 \dot{I}_1 + \frac{Q_1}{C_1} + R_1 (I_1 - I_2) &= 0 \\ L_2 \dot{I}_2 + R_2 I_2 + R_1 (I_2 - I_1) &= V(t) . \end{aligned} \quad (2.57)$$

Let $Q_1(t)$ be the charge on the left plate of capacitor C_1 , and define

$$Q_2(t) = \int_0^t dt' I_2(t') . \quad (2.58)$$

Then Kirchoff's laws may be written

$$\begin{aligned} \ddot{Q}_1 + \frac{R_1}{L_1} (\dot{Q}_1 - \dot{Q}_2) + \frac{1}{L_1 C_1} Q_1 &= 0 \\ \ddot{Q}_2 + \frac{R_2}{L_2} \dot{Q}_2 + \frac{R_1}{L_2} (\dot{Q}_2 - \dot{Q}_1) &= \frac{V(t)}{L_2} . \end{aligned} \quad (2.59)$$

Now consider the mechanical system in fig. 2.6. The blocks have masses M_1 and M_2 . The friction coefficient between blocks 1 and 2 is b_1 , and the friction coefficient between block 2 and the floor is b_2 . Here we assume a velocity-dependent frictional force $F_f = -b\dot{x}$, rather than the more conventional constant $F_f = -\mu W$, where W is the weight of an object. Velocity-dependent friction is applicable when the relative velocity of an object and a surface is sufficiently large. There is a spring of spring constant k_1 which connects block 1 to the wall. Finally, block 2 is driven by a periodic acceleration $f_0 \cos(\omega t)$. We now identify

$$X_1 \leftrightarrow Q_1 , \quad X_2 \leftrightarrow Q_2 , \quad b_1 \leftrightarrow \frac{R_1}{L_1} , \quad b_2 \leftrightarrow \frac{R_2}{L_2} , \quad k_1 \leftrightarrow \frac{1}{L_1 C_1} , \quad (2.60)$$

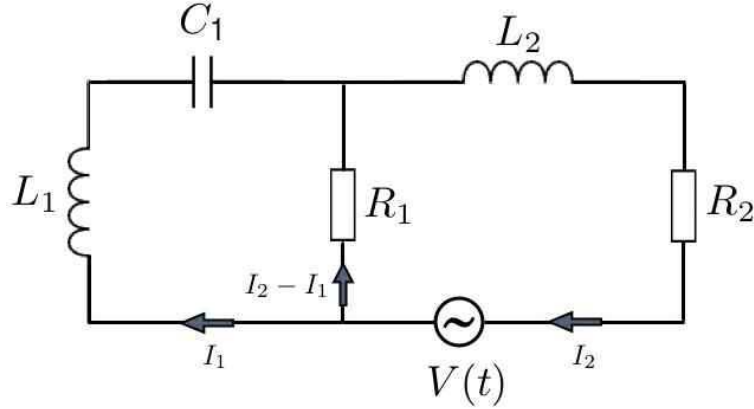

Figure 2.5: A driven L - C - R circuit, with $V(t) = V_0 \cos(\omega t)$.

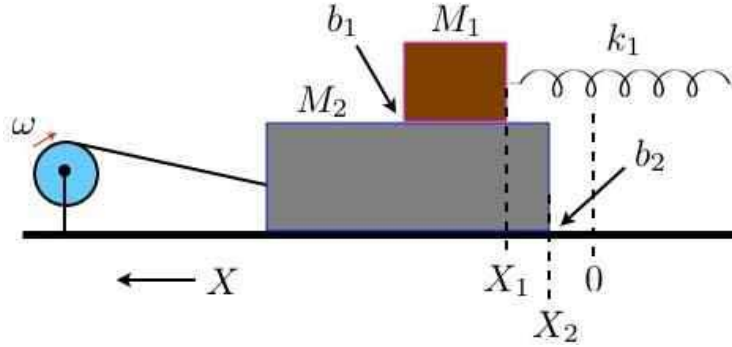

Figure 2.6: The equivalent mechanical circuit for fig. 2.5.

as well as $f(t) \leftrightarrow V(t)/L_2$.

The solution again proceeds by Fourier transform. We write

$$V(t) = \int_{-\infty}^{\infty} \frac{d\omega}{2\pi} \hat{V}(\omega) e^{-i\omega t} \quad (2.61)$$

and

$$\begin{Bmatrix} Q_1(t) \\ \hat{I}_2(t) \end{Bmatrix} = \int_{-\infty}^{\infty} \frac{d\omega}{2\pi} \begin{Bmatrix} \hat{Q}_1(\omega) \\ \hat{I}_2(\omega) \end{Bmatrix} e^{-i\omega t} \quad (2.62)$$

The frequency space version of Kirchoff's laws for this problem is

$$\overbrace{\begin{pmatrix} -\omega^2 - i\omega R_1/L_1 + 1/L_1 C_1 & R_1/L_1 \\ i\omega R_1/L_2 & -i\omega + (R_1 + R_2)/L_2 \end{pmatrix}}^{\hat{G}(\omega)} \begin{pmatrix} \hat{Q}_1(\omega) \\ \hat{I}_2(\omega) \end{pmatrix} = \begin{pmatrix} 0 \\ \hat{V}(\omega)/L_2 \end{pmatrix} \quad (2.63)$$

The homogeneous equation has eigenfrequencies given by the solution to $\det \hat{G}(\omega) = 0$, which is a cubic equation. Correspondingly, there are three initial conditions to account for: $Q_1(0)$, $I_1(0)$, and $I_2(0)$. As in the case of the single damped harmonic oscillator, these transients are damped, and for large times may be ignored. The solution then is

$$\begin{pmatrix} \hat{Q}_1(\omega) \\ \hat{I}_2(\omega) \end{pmatrix} = \begin{pmatrix} -\omega^2 - i\omega R_1/L_1 + 1/L_1 C_1 & R_1/L_1 \\ i\omega R_1/L_2 & -i\omega + (R_1 + R_2)/L_2 \end{pmatrix}^{-1} \begin{pmatrix} 0 \\ \hat{V}(\omega)/L_2 \end{pmatrix}. \quad (2.64)$$

To obtain the time-dependent $Q_1(t)$ and $I_2(t)$, we must compute the Fourier transform back to the time domain.

2.4 General Solution by Green's Function Method

For a general forcing function $f(t)$, we solve by Fourier transform. Recall that a function $F(t)$ in the time domain has a Fourier transform $\hat{F}(\omega)$ in the frequency domain. The relation between the two is:¹

$$F(t) = \int_{-\infty}^{\infty} \frac{d\omega}{2\pi} e^{-i\omega t} \hat{F}(\omega) \iff \hat{F}(\omega) = \int_{-\infty}^{\infty} dt e^{+i\omega t} F(t). \quad (2.65)$$

We can convert the differential equation 2.3 to an algebraic equation in the frequency domain, $\hat{x}(\omega) = \hat{G}(\omega) \hat{f}(\omega)$, where

$$\hat{G}(\omega) = \frac{1}{\omega_0^2 - 2i\beta\omega - \omega^2} \quad (2.66)$$

is the *Green's function* in the frequency domain. The general solution is written

$$x(t) = \int_{-\infty}^{\infty} \frac{d\omega}{2\pi} e^{-i\omega t} \hat{G}(\omega) \hat{f}(\omega) + x_h(t), \quad (2.67)$$

where $x_h(t) = \sum_i C_i e^{-i\omega_i t}$ is a solution to the homogeneous equation. We may also write the above integral over the time domain:

$$x(t) = \int_{-\infty}^{\infty} dt' G(t-t') f(t') + x_h(t) \quad (2.68)$$

$$\begin{aligned} G(s) &= \int_{-\infty}^{\infty} \frac{d\omega}{2\pi} e^{-i\omega s} \hat{G}(\omega) \\ &= \nu^{-1} \exp(-\beta s) \sin(\nu s) \Theta(s) \end{aligned} \quad (2.69)$$

¹Different texts often use different conventions for Fourier and inverse Fourier transforms. Sometimes the factor of $(2\pi)^{-1}$ is associated with the time integral, and sometimes a factor of $(2\pi)^{-1/2}$ is assigned to both frequency and time integrals. The convention I use is obviously the best.

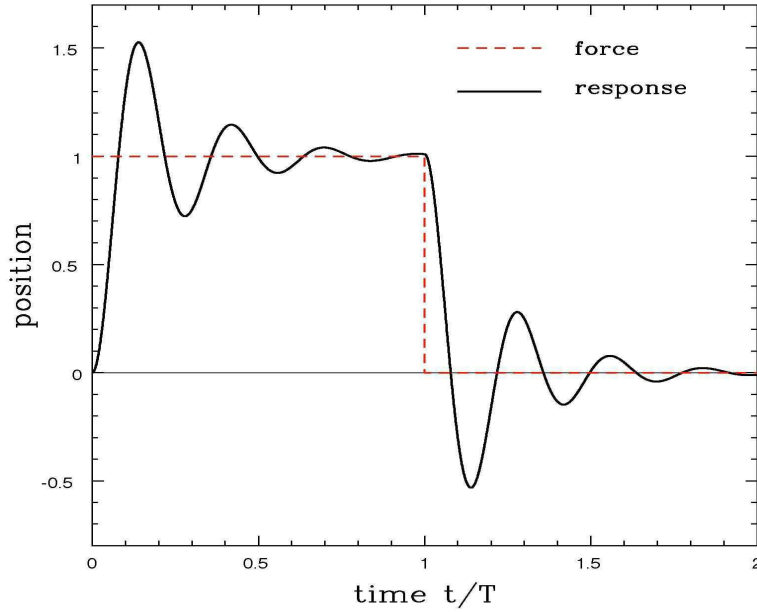

Figure 2.7: Response of an underdamped oscillator to a pulse force.

where $\Theta(s)$ is the *step function*,

$$\Theta(s) = \begin{cases} 1 & \text{if } s \geq 0 \\ 0 & \text{if } s < 0 \end{cases} \quad (2.70)$$

where once again $\nu \equiv \sqrt{\omega_0^2 - \beta^2}$. In the overdamped case, we write $\nu = i\lambda$ with $\lambda = \sqrt{\beta^2 - \omega_0^2}$, and we then have

$$G(s) = \lambda^{-1} \exp(-\beta s) \sinh(\lambda s) \Theta(s) \quad . \quad (2.71)$$

Example: force pulse

Consider a pulse force

$$f(t) = f_0 \Theta(t) \Theta(T - t) = \begin{cases} f_0 & \text{if } 0 \leq t \leq T \\ 0 & \text{otherwise.} \end{cases} \quad (2.72)$$

In the underdamped regime, for example, and ignoring the transients, we find the solution

$$x(t) = \frac{f_0}{\omega_0^2} \left\{ 1 - e^{-\beta t} \cos \nu t - \frac{\beta}{\nu} e^{-\beta t} \sin \nu t \right\} \quad (2.73)$$

if $0 \leq t \leq T$ and

$$x(t) = \frac{f_0}{\omega_0^2} \left\{ \left(e^{-\beta(t-T)} \cos \nu(t-T) - e^{-\beta t} \cos \nu t \right) + \frac{\beta}{\nu} \left(e^{-\beta(t-T)} \sin \nu(t-T) - e^{-\beta t} \sin \nu t \right) \right\} \quad (2.74)$$

if $t > T$.

2.5 General Linear Autonomous Inhomogeneous ODEs

This method immediately generalizes to the case of general autonomous linear inhomogeneous ODEs of the form

$$\frac{d^n x}{dt^n} + a_{n-1} \frac{d^{n-1} x}{dt^{n-1}} + \dots + a_1 \frac{dx}{dt} + a_0 x = f(t) \quad . \quad (2.75)$$

We can write this as

$$\mathcal{L}_t x(t) = f(t) \quad , \quad (2.76)$$

where \mathcal{L}_t is the n^{th} order differential operator

$$\mathcal{L}_t = \frac{d^n}{dt^n} + a_{n-1} \frac{d^{n-1}}{dt^{n-1}} + \dots + a_1 \frac{d}{dt} + a_0 \quad . \quad (2.77)$$

The general solution to the inhomogeneous equation is given by

$$x(t) = x_h(t) + \int_{-\infty}^{\infty} dt' G(t, t') f(t') \quad , \quad (2.78)$$

where $G(t, t')$ is the Green's function. Note that $\mathcal{L}_t x_h(t) = 0$. Thus, in order for eqns. 2.76 and 2.78 to be true, we must have

$$\mathcal{L}_t x(t) = \overbrace{\mathcal{L}_t x_h(t)}^{\text{this vanishes}} + \int_{-\infty}^{\infty} dt' \mathcal{L}_t G(t, t') f(t') = f(t) \quad , \quad (2.79)$$

which means that

$$\mathcal{L}_t G(t, t') = \delta(t - t') \quad , \quad (2.80)$$

where $\delta(t - t')$ is the Dirac δ -function. Some properties of $\delta(x)$:

$$\int_a^b dx f(x) \delta(x - y) = \begin{cases} f(y) & \text{if } a < y < b \\ 0 & \text{if } y < a \text{ or } y > b \end{cases} \quad . \quad (2.81)$$

$$\delta(g(x)) = \sum_{\substack{x_i \text{ with} \\ g(x_i) = 0}} \frac{\delta(x - x_i)}{|g'(x_i)|} \quad , \quad (2.82)$$

valid for any functions $f(x)$ and $g(x)$. The sum in the second equation is over the zeros x_i of $g(x)$.

Incidentally, the Dirac δ -function enters into the relation between a function and its Fourier transform, in the following sense. We have

$$f(t) = \int_{-\infty}^{\infty} \frac{d\omega}{2\pi} e^{-i\omega t} \hat{f}(\omega) \quad , \quad \hat{f}(\omega) = \int_{-\infty}^{\infty} dt e^{+i\omega t} f(t) \quad . \quad (2.83)$$

Substituting the second equation into the first, we have

$$f(t) = \int_{-\infty}^{\infty} \frac{d\omega}{2\pi} e^{-i\omega t} \int_{-\infty}^{\infty} dt' e^{i\omega t'} f(t') = \int_{-\infty}^{\infty} dt' \left\{ \int_{-\infty}^{\infty} \frac{d\omega}{2\pi} e^{i\omega(t'-t)} \right\} f(t') \quad , \quad (2.84)$$

which is indeed correct because the term in brackets is a representation of $\delta(t - t')$:

$$\int_{-\infty}^{\infty} \frac{d\omega}{2\pi} e^{i\omega s} = \delta(s) \quad . \quad (2.85)$$

If the differential equation $\mathcal{L}_t x(t) = f(t)$ is defined over some finite t interval with prescribed boundary conditions on $x(t)$ at the endpoints, then $G(t, t')$ will depend on t and t' separately. For the case we are considering, the interval is the entire real line $t \in (-\infty, \infty)$, and $G(t, t') = G(t - t')$ is a function of the single variable $t - t'$.

Note that $\mathcal{L}_t = \mathcal{L}\left(\frac{d}{dt}\right)$ may be considered a function of the differential operator $\frac{d}{dt}$. If we now Fourier transform the equation $\mathcal{L}_t x(t) = f(t)$, we obtain

$$\begin{aligned} \int_{-\infty}^{\infty} dt e^{i\omega t} f(t) &= \int_{-\infty}^{\infty} dt e^{i\omega t} \left\{ \frac{d^n}{dt^n} + a_{n-1} \frac{d^{n-1}}{dt^{n-1}} + \dots + a_1 \frac{d}{dt} + a_0 \right\} x(t) \\ &= \int_{-\infty}^{\infty} dt e^{i\omega t} \left\{ (-i\omega)^n + a_{n-1} (-i\omega)^{n-1} + \dots + a_1 (-i\omega) + a_0 \right\} x(t) \quad , \end{aligned} \quad (2.86)$$

where we integrate by parts on t , assuming the boundary terms at $t = \pm\infty$ vanish, *i.e.* $x(\pm\infty) = 0$, so that, inside the t integral,

$$e^{i\omega t} \left(\frac{d}{dt} \right)^k x(t) \rightarrow \left[\left(-\frac{d}{dt} \right)^k e^{i\omega t} \right] x(t) = (-i\omega)^k e^{i\omega t} x(t) \quad . \quad (2.87)$$

Thus, if we define

$$\hat{\mathcal{L}}(\omega) = \sum_{k=0}^n a_k (-i\omega)^k \quad , \quad (2.88)$$

then we have

$$\hat{\mathcal{L}}(\omega) \hat{x}(\omega) = \hat{f}(\omega) \quad , \quad (2.89)$$

where $a_n \equiv 1$. According to the Fundamental Theorem of Algebra, the n^{th} degree polynomial $\hat{\mathcal{L}}(\omega)$ may be uniquely factored over the complex ω plane into a product over n roots:

$$\hat{\mathcal{L}}(\omega) = (-i)^n (\omega - \omega_1)(\omega - \omega_2) \cdots (\omega - \omega_n) \quad . \quad (2.90)$$

If the $\{a_k\}$ are all real, then $[\hat{\mathcal{L}}(\omega)]^* = \hat{\mathcal{L}}(-\omega^*)$, hence if Ω is a root then so is $-\Omega^*$. Thus, the roots appear in pairs which are symmetric about the imaginary axis. *I.e.* if $\Omega = a + ib$ is a root, then so is $-\Omega^* = -a + ib$.

The general solution to the homogeneous equation is

$$x_h(t) = \sum_{i=1}^n A_i e^{-i\omega_i t} \quad , \quad (2.91)$$

which involves n arbitrary complex constants A_i . The susceptibility, or Green's function in Fourier space, $\hat{G}(\omega)$ is then

$$\hat{G}(\omega) = \frac{1}{\hat{\mathcal{L}}(\omega)} = \frac{i^n}{(\omega - \omega_1)(\omega - \omega_2) \cdots (\omega - \omega_n)} \quad , \quad (2.92)$$

and the general solution to the inhomogeneous equation is again given by

$$x(t) = x_h(t) + \int_{-\infty}^{\infty} dt' G(t-t') f(t') \quad , \quad (2.93)$$

where $x_h(t)$ is the solution to the homogeneous equation, *i.e.* with zero forcing, and where

$$\begin{aligned} G(s) &= \int_{-\infty}^{\infty} \frac{d\omega}{2\pi} e^{-i\omega s} \hat{G}(\omega) \\ &= i^n \int_{-\infty}^{\infty} \frac{d\omega}{2\pi} \frac{e^{-i\omega s}}{(\omega - \omega_1)(\omega - \omega_2) \cdots (\omega - \omega_n)} = \sum_{j=1}^n \frac{e^{-i\omega_j s}}{i \mathcal{L}'(\omega_j)} \Theta(s) \quad , \end{aligned} \quad (2.94)$$

where we assume that $\text{Im}(\omega_j) < 0$ for all j . The integral above was done using Cauchy's theorem and the calculus of residues – a beautiful result from the theory of complex functions.

As an example, consider the familiar case

$$\hat{\mathcal{L}}(\omega) = \omega_0^2 - 2i\beta\omega - \omega^2 = -(\omega - \omega_+)(\omega - \omega_-) \quad , \quad (2.95)$$

with $\omega_{\pm} = -i\beta \pm \nu$, and $\nu = (\omega_0^2 - \beta^2)^{1/2}$. This yields

$$\mathcal{L}'(\omega_{\pm}) = \mp(\omega_+ - \omega_-) = \mp 2\nu \quad . \quad (2.96)$$

Then according to equation 2.94,

$$\begin{aligned} G(s) &= \left\{ \frac{e^{-i\omega_+ s}}{i \mathcal{L}'(\omega_+)} + \frac{e^{-i\omega_- s}}{i \mathcal{L}'(\omega_-)} \right\} \Theta(s) \\ &= \left\{ \frac{e^{-\beta s} e^{-i\nu s}}{-2i\nu} + \frac{e^{-\beta s} e^{i\nu s}}{2i\nu} \right\} \Theta(s) = \nu^{-1} e^{-\beta s} \sin(\nu s) \Theta(s) \quad , \end{aligned} \quad (2.97)$$

exactly as before.

2.6 Kramers-Krönig Relations

Suppose $\hat{\chi}(\omega) \equiv \hat{G}(\omega)$ is analytic in the UHP². Then for all ν , we must have

$$\int_{-\infty}^{\infty} \frac{d\nu}{2\pi} \frac{\hat{\chi}(\nu)}{\nu - \omega + i\epsilon} = 0 \quad , \quad (2.98)$$

where ϵ is a positive infinitesimal. The reason is simple: just close the contour in the UHP, assuming $\hat{\chi}(\omega)$ vanishes sufficiently rapidly that Jordan's lemma can be applied. Clearly this is an extremely weak restriction on $\hat{\chi}(\omega)$, given the fact that the denominator already causes the integrand to vanish as $|\omega|^{-1}$.

Let us examine the function

$$\frac{1}{\nu - \omega + i\epsilon} = \frac{\nu - \omega}{(\nu - \omega)^2 + \epsilon^2} - \frac{i\epsilon}{(\nu - \omega)^2 + \epsilon^2} \quad . \quad (2.99)$$

which we have separated into real and imaginary parts. Under an integral sign, the first term, in the limit $\epsilon \rightarrow 0$, is equivalent to taking a *principal part* of the integral. That is, for any function $F(\nu)$ which is regular at $\nu = \omega$,

$$\lim_{\epsilon \rightarrow 0} \int_{-\infty}^{\infty} \frac{d\nu}{2\pi} \frac{\nu - \omega}{(\nu - \omega)^2 + \epsilon^2} F(\nu) \equiv \mathcal{P} \int_{-\infty}^{\infty} \frac{d\nu}{2\pi} \frac{F(\nu)}{\nu - \omega} \quad . \quad (2.100)$$

The principal part symbol \mathcal{P} means that the singularity at $\nu = \omega$ is elided, either by smoothing out the function $1/(\nu - \epsilon)$ as above, or by simply cutting out a region of integration of width ϵ on either side of $\nu = \omega$.

The imaginary part is more interesting. Let us write

$$h(u) \equiv \frac{\epsilon}{u^2 + \epsilon^2} \quad . \quad (2.101)$$

For $|u| \gg \epsilon$, $h(u) \simeq \epsilon/u^2$, which vanishes as $\epsilon \rightarrow 0$. For $u = 0$, $h(0) = 1/\epsilon$ which diverges as $\epsilon \rightarrow 0$. Thus, $h(u)$ has a huge peak at $u = 0$ and rapidly decays to 0 as one moves off the peak in either direction a distance greater than ϵ . Finally, note that

$$\int_{-\infty}^{\infty} du h(u) = \pi \quad , \quad (2.102)$$

a result which itself is easy to show using contour integration. Putting it all together, this tells us that

$$\lim_{\epsilon \rightarrow 0} \frac{\epsilon}{u^2 + \epsilon^2} = \pi \delta(u) \quad . \quad (2.103)$$

Thus, for positive infinitesimal ϵ ,

$$\frac{1}{u \pm i\epsilon} = \mathcal{P} \frac{1}{u} \mp i\pi \delta(u) \quad , \quad (2.104)$$

²In this section, we use the notation $\hat{\chi}(\omega)$ for the susceptibility, rather than $\hat{G}(\omega)$

a most useful result.

We now return to our initial result 2.98, and we separate $\hat{\chi}(\omega)$ into real and imaginary parts:

$$\hat{\chi}(\omega) = \hat{\chi}'(\omega) + i\hat{\chi}''(\omega) \quad . \quad (2.105)$$

(In this equation, the primes do not indicate differentiation with respect to argument.) We therefore have, for every real value of ω ,

$$0 = \int_{-\infty}^{\infty} \frac{d\nu}{2\pi} [\chi'(\nu) + i\chi''(\nu)] \left[\mathcal{P} \frac{1}{\nu - \omega} - i\pi\delta(\nu - \omega) \right] \quad . \quad (2.106)$$

Taking the real and imaginary parts of this equation, we derive the *Kramers-Krönig relations*:

$$\begin{aligned} \chi'(\omega) &= +\mathcal{P} \int_{-\infty}^{\infty} \frac{d\nu}{\pi} \frac{\hat{\chi}''(\nu)}{\nu - \omega} \\ \chi''(\omega) &= -\mathcal{P} \int_{-\infty}^{\infty} \frac{d\nu}{\pi} \frac{\hat{\chi}'(\nu)}{\nu - \omega} \quad . \end{aligned} \quad (2.107)$$