

Lecture 15

White Dwarfs, Neutron Stars,
Black Holes

Outline of Lecture 15

- White Dwarfs (WDs) are supported against their self-gravity by *electron degeneracy pressure*. Because electrons cannot move faster than c , WDs have a maximum mass, the *Chandrasekhar limit* $= 1.4 M_{\odot}$.
- Neutron Stars (NSs) are supported against their self-gravity (primarily) by *neutron degeneracy pressure*. As a consequence, NSs are typically 600 times smaller than WDs. Maximum mass of NS $\approx 3M_{\odot}$.
- Black holes (BHs) arise when matter cannot generate enough resistance to oppose self-gravity. Ever more pressure is ultimately self-defeating, because according to Einstein's theory of general relativity, pressure is an extra source for gravitation. The gravity of a BH of mass M is so large (at small distances) that even light cannot escape from the *event horizon* of a BH, with *Schwarzschild radius*:

$$R_{Sch} = \frac{2GM}{c^2}.$$

Sirius, at the Collar of *Canis Majoris*

- Assuming that all stars are as intrinsically as bright as the Sun, Huygens deduced that Sirius might be the brightest star in the night sky because it is the nearest star to Earth. (It is only one of the nearest). In a book published posthumously in 1698, Huygens described a method for estimating the distance to Sirius.
- Through a small pinhole punched through a shade in a darkened Church, he observed a small piece of the day sky (lit up by the Sun at 1 AU). He increased his distance from the pinhole until he judged the light to be comparably bright as how he remembered Sirius to shine the night before. From the fractional coverage of the pinhole of the whole sky at his position, he computed that Sirius is 27,000 times farther away than the Sun. In contemporary terms, Sirius is then at a distance of 27,000 AU, or 0.44 lt-yr.
- Huygens's estimate is a factor of 19 too small compared to modern determinations, because Sirius is intrinsically 21 times more luminous than the Sun, the sky scatters only $\sim 20\%$ of the visible light of the Sun, and the human memory and eye are not faithful recording devices.

- A little after sunset in November

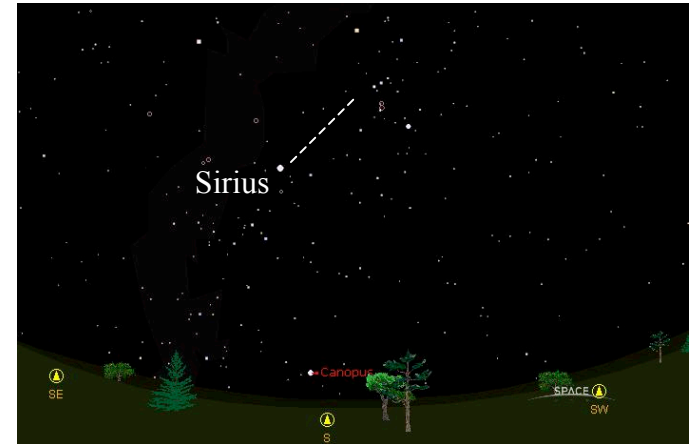

- Huygens's ingenious method provided a first hint of the enormous distances of even the closest stars. It indicated that *arcsecond*, not arcminute, positional accuracy would be needed if astronomers were to measure *stellar parallax*.

Sirius Has a White Dwarf Companion

Derivation

(extra material):

$$M + m = 3M_{\odot} \text{ from}$$

$$P^2 = \frac{4\pi^2 a^3}{G(M + m)}.$$

$$m = \frac{1}{2}M \text{ from}$$

Sirius B's orbit about CM being 2 times larger than Sirius A's.

- In 1718, Edmund Halley compared his measurements of the positions of Sirius, Arcturus, and Aldebaran with those given by Hipparchus and found that these three bright stars had moved by about half a degree (1800 arcsec) with respect to “stationary” background stars since Hipparchus’s time. For a given linear velocity across the line of sight, the “proper motion” is greater the closer is the object. Sirius’s large proper motion of 1.34 arcsec per year in a straight line is again an indicator of its proximity to the solar system.
- A century later Bessel (1784-1846) measured that Sirius has a trigonometric parallax close to the modern value 0.379 arcsec, i.e., Sirius lies at a distance of $1 \text{ AU}/0.379 \text{ arcsec} = 2.64 \text{ parsec} = 8.5 \text{ lt-yr}$ from the Earth. He also found that Sirius’s proper motion is not in a perfect straight line, but has a wobble. Sirius has an unseen orbiting companion! Masses: $M_A = 2 M_{\odot}$, $M_B = 1 M_{\odot}$, yet Sirius B is almost 10,000 times fainter than Sirius A. Sirius A and B have same color, i.e., T_e . Sirius B has 100 smaller radius than Sirius A; i.e., it has the mass of the Sun, but the size of the Earth! It is a white dwarf, with a mean density a million times greater than liquid water.

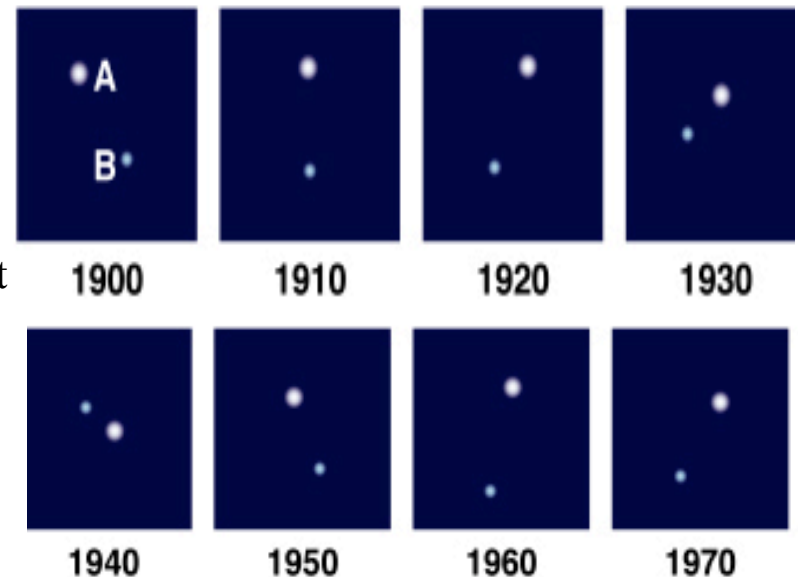
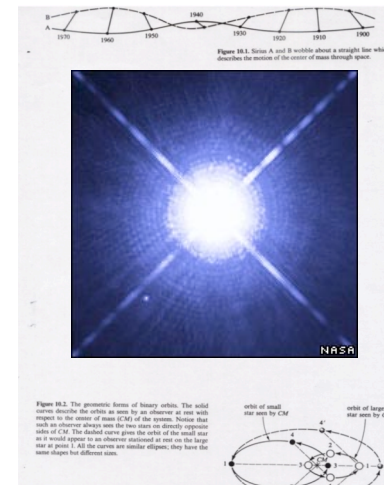

Theory of White Dwarfs

- Sugar cube of white dwarf matter weighs as much as a car. It is 50,000 times denser than depleted U.
- R. H. Fowler (1889-1944) proposes white dwarfs, made of element of mean atomic number Z and atomic weight A , are supported against self-gravity by electron degeneracy pressure \rightarrow mass-radius relationship such that $R \downarrow$ as $M \uparrow$:

$$R = 0.114 \frac{h^2}{G m_e m_p^{5/3}} \left(\frac{Z}{A} \right)^{5/3} M^{-1/3}.$$

- For $M = 1 M_\odot$ and $Z/A = 1/2$, R is somewhat smaller than radius of Earth.
- S. Chandrasekhar (1910-1995) includes effect of special relativity, finds $R \rightarrow 0$ as $M \rightarrow$ finite value (Chandrasekhar's limit).
- Controversy between Eddington and Chandrasekhar. Chandrasekhar leaves England for United States, settles in University of Chicago. Gave moving tribute in 1982 to commemorate 100th anniversary of Eddington's birth. Awarded Nobel Prize in Physics in 1984.

Difference between chocolate cakes and white dwarfs

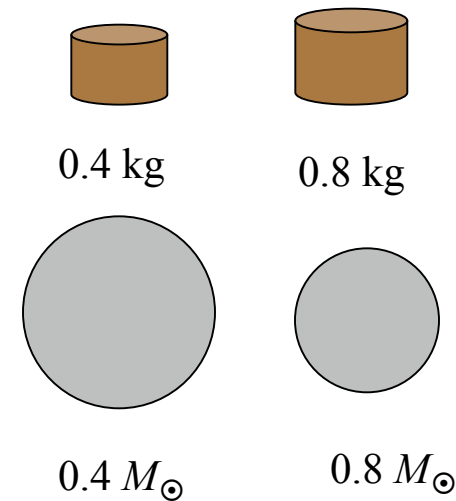

- As $M \uparrow$, $v_e \rightarrow c$, and P increases less quickly when density \uparrow . Radius $\rightarrow 0$

when $M \rightarrow M_{\text{Ch}}$ where

$$M_{\text{Ch}} = 0.20 \left(\frac{Z}{A} \right)^2 \left(\frac{hc}{G m_p^2} \right)^{3/2} m_p = 1.4 M_\odot$$

for $Z/A = 1/2$.

Mass-Radius Relationship of Cold, Self-Gravitating Bodies

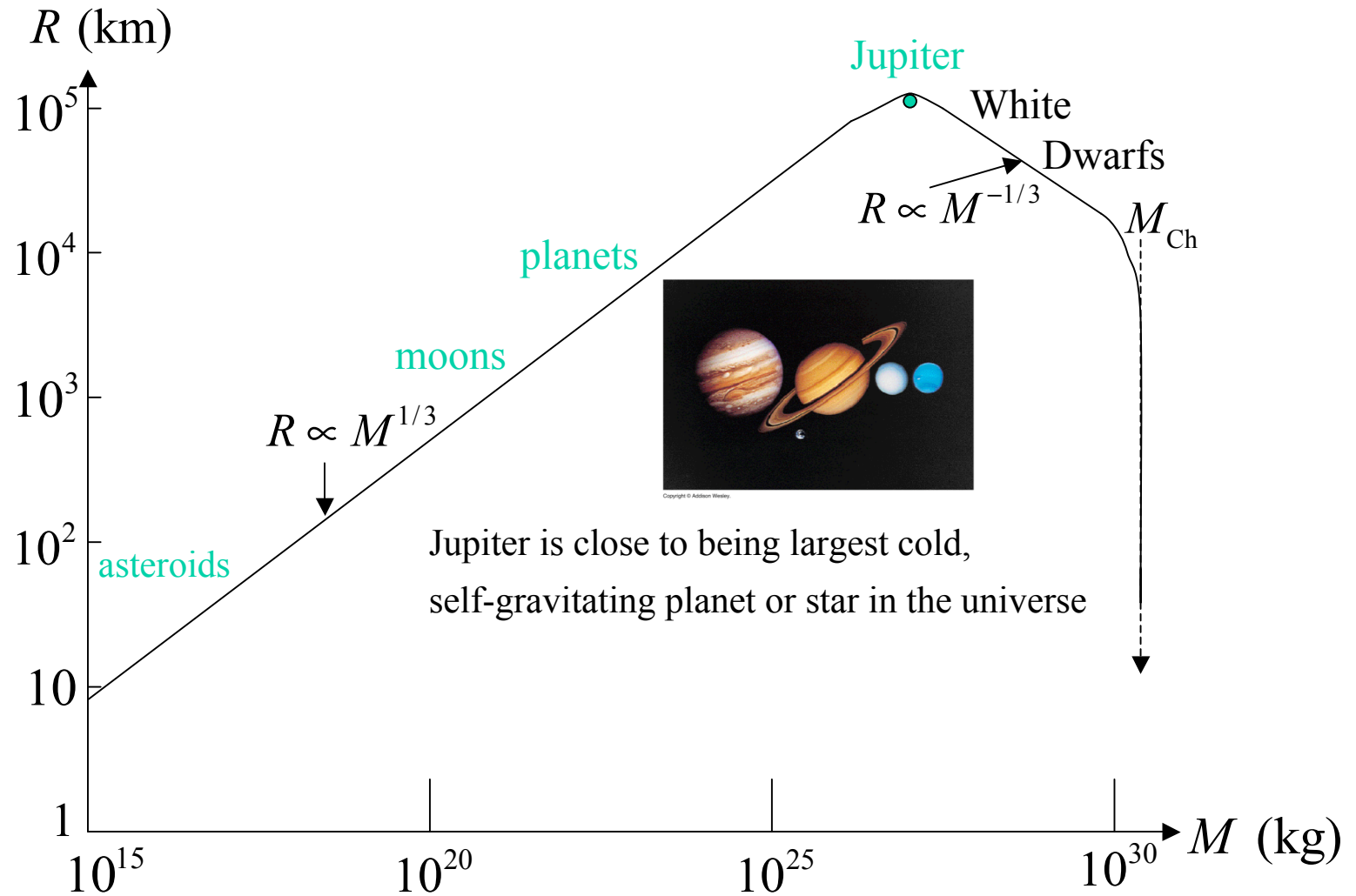

Similarity Between Cooling Ember and White Dwarf

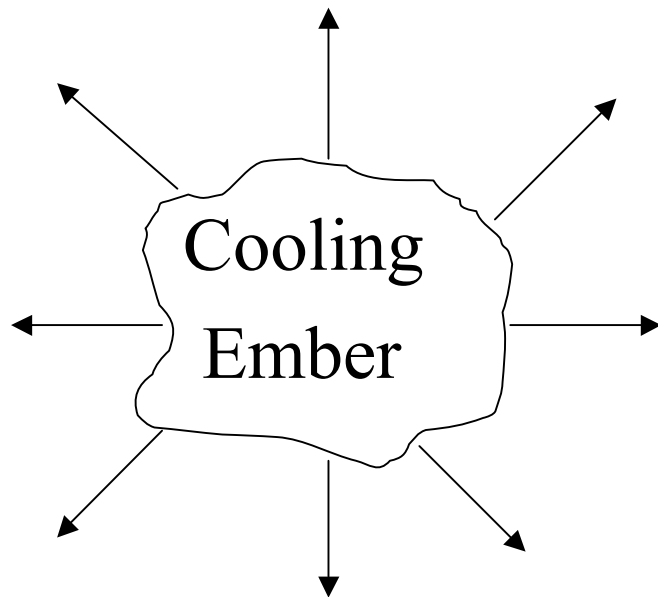

Radiates energy,
becomes cooler.

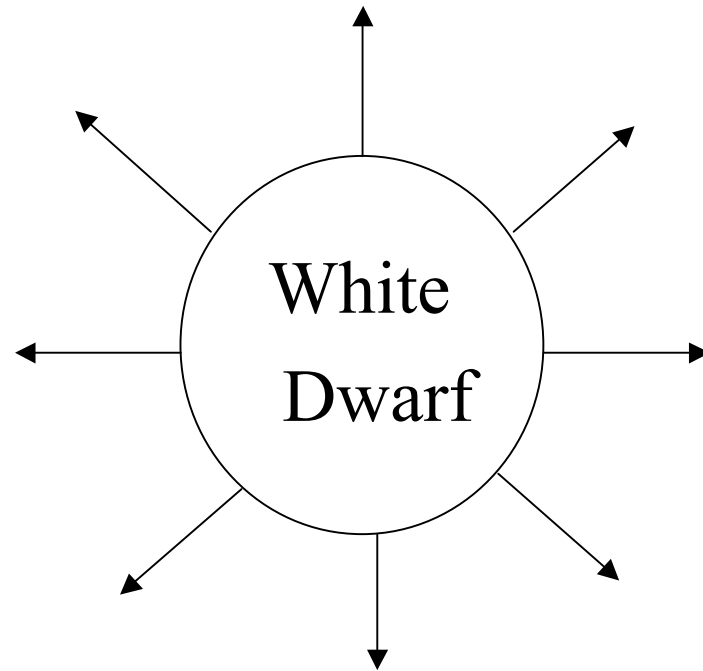

Radiates energy,
becomes cooler.

War between self-gravitation and thermodynamics can be mediated by quantum degeneracy of electrons. (It may be an uneasy peace, however.)

Path to Yet More Compact Objects

- If M were to exceed 1.4 solar masses, would R of a WD really shrink to zero?
- As ρ rises, electron degeneracy-energy becomes greater (electrons squeezed closer together must have greater momenta difference according to combination of Pauli exclusion and Heisenberg uncertainty principles). Eventually, extra degeneracy energy can make up the mass difference between a proton and a neutron (discovered by Chadwick in 1932).
- Electrons get “squashed” inside protons, and ions of a WD star become converted to neutrons.
- As ρ rises even more, neutrons become degenerate and are able to exert pressure at zero T .
- The balance of neutron degeneracy pressure and self-gravity gives rise to a new state of possible equilibrium, a *neutron star* (predicted by Lev Landau in 1932 shortly after he learned of Chadwick’s discovery of the neutron).
- **Simplest theory (extra material):**
In formula for WD

$$R = 0.114 \frac{h^2}{G m_e m_p^{5/3}} \left(\frac{Z}{A} \right)^{5/3} M^{-1/3}.$$
 replace m_e and m_p by m_n and Z/A by 1.
- For given stellar mass, white dwarf is larger than neutron star roughly by factor $2^{-5/3} m_n/m_e \sim 600$.
- **WD size of Earth, NS size of a city.**
- If neutrons stars are smaller than white dwarfs by a factor 600 and they have comparable masses, their mean density is higher than those of WD by factor of $600^3 \approx 2 \times 10^8$;
i.e., $\bar{\rho}_{\text{NS}} \approx 2 \times 10^{17} \text{ kg m}^{-3}$.

Neutron Stars

- $\bar{\rho} \approx 2 \times 10^{17} \text{ kg m}^{-3}$ is comparable to density of atomic nuclei.
- At such densities (nuclear densities), matter is very incompressible (because neutrons get pushed right up “one against another”), with the pressure rising rapidly as the density increases.
- Rate of rise of pressure with density = square of speed of sound. Speed of sound cannot exceed speed of light \rightarrow limit to how much matter, even nuclear matter, can resist gravity \rightarrow

$$M_{\text{NS}} < 3M_{\odot}.$$

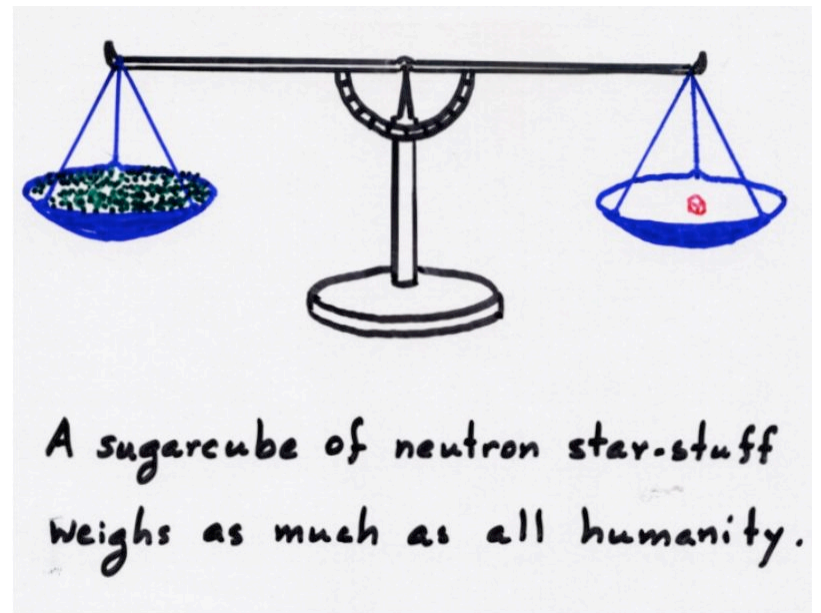

Another way to express the same thought:
If one were to squash orbital electrons into the nuclei of atoms (i.e., remove all the empty space that is in humans), all of humanity would fit into the volume of a sugar cube.

Detection of Neutron Stars as Pulsars

- Because of their small radiating surface areas, the *thermal radiation* from neutron stars was *not detectable* until fairly recently (by the Chandra X-Ray Observatory in 2001).
- However, many neutron stars possess *powerful magnetic fields*, with surface values a trillion or more times stronger than that on Earth (or, as an average, on the Sun).
- Many neutron stars also *spin rapidly* on axes that are not aligned with the magnetic field axes. Measured rotation periods are as short as milliseconds.
- This combination produces a time-variable magnetic field (as seen by an inertial observer), and a resultant *pulsed emission of nonthermal electromagnetic radiation*, giving the source its name, *pulsar*.
- Since the observed pulsed radiation, from radio waves to X-rays (in some sources), has frequencies much higher than the rotation frequency, the exact *mechanism of pulsar emission* remains elusive to the present day. The most promising ideas involve the generation of strong electric fields (from the rotationally induced time-varying magnetic fields) that accelerate charged particles off the surface of the neutron star, causing them to produce additional particles and antiparticles that radiate as a byproduct of the creation process.

Crab nebula,
site of SN
explosion
in 1054

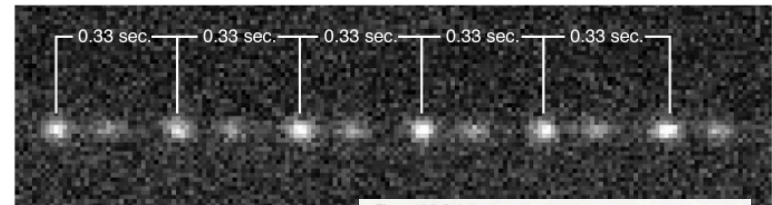
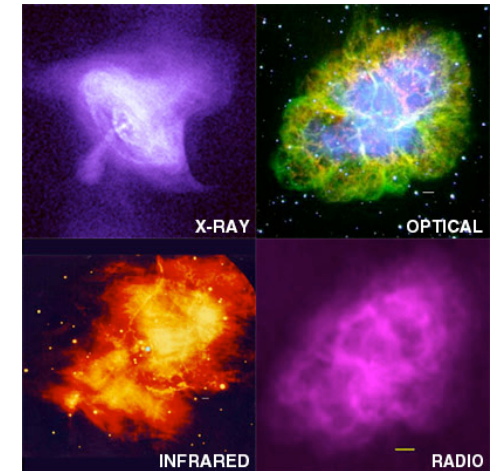

Figure 15.5 Pulsar

Copyright © Addison Wesley

Pulsars blink
like rotating
lighthouses



Copyright © Addison Wesley Longman, Inc.

Idea of Black Hole

- Consider the escape speed from the surface of a body of mass M and radius R :

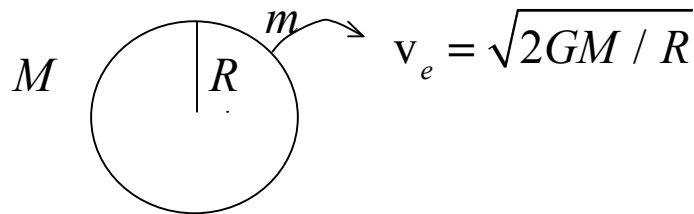

Derivation (extra material):

$$E = \frac{1}{2}mv^2 - \frac{GMm}{R} = 0 \quad \text{for} \quad v = v_e$$

- For a neutron star of mass $M = 1.4M_{\odot}$ and radius $R = 10^4$ m, we get

$$v_e = 1.9 \times 10^8 \text{ m/s,}$$

which is 63% the speed of light c !

- The above calculation motivates us to ask a question first asked by Pierre Laplace (1749-1827): For given M , what R would yield an escape speed equal to c ? Answer:

$$R = \frac{2GM}{c^2}.$$

- This is the correct answer, but the reasoning is incorrect on two counts.
 - First, Newtonian mechanics giving the equation for a marginally bound orbit (see extra material) does not apply to photons of zero rest mass m and speed c .
 - Second, Newtonian concepts about gravity do not apply to a situation where the gravitational field of a body is so strong that even light finds it difficult to escape its clutches.
- Two mistakes combine to give the right looking answer! Correct derivation based on [Einstein's theory of general relativity](#) first given by Karl Schwarzschild (1873-1916) as he lay dying on Russian front in WW I.

Event Horizon of Black Hole

Black Hole

- Given M , what R would require escape speed $= c$?

Laplace: $R = 2GM/c^2$

- Schwarzschild's analysis: Photon with wavelength λ at event horizon of black hole will emerge at infinity with its wavelength infinitely redshifted

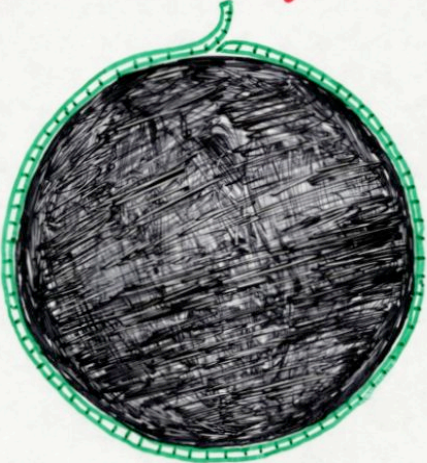

Schwarzschild: circumference of event horizon $= 2\pi R$

where $R = 2GM/c^2$. For $M = 3M_{\odot}$, $R_{Sch} = 9 \text{ km}$

- Two Views of Gravitation

- Newton:

- Gravity is a force which pulls on all things with mass.
 - Mass acts as the source that generates the force of gravitation.

- Einstein:

- There is no such thing as the force of gravity. Gravitation arises when spacetime has curvature; indeed gravitation is spacetime curvature.
 - Mass-energy and stress (e.g., pressure) act as the sources that generate spacetime curvature.

Notice that Einstein's geometric view of gravitation is a partial vindication of Aristotle's philosophy!

Basic Postulates of General Relativity

- In special relativity, nothing can travel faster than the speed of light.
- In Newton's theory of gravitation, the information concerning the force of gravitation $F = GMm/r^2$ travels instantaneously to all separation distances even as masses move: "action at a distance."
- Einstein therefore knows that Newton's theory, despite its great success in the regime when $v \ll c$, is flawed at its foundation.
- What can replace this foundation? Go back to Galileo.

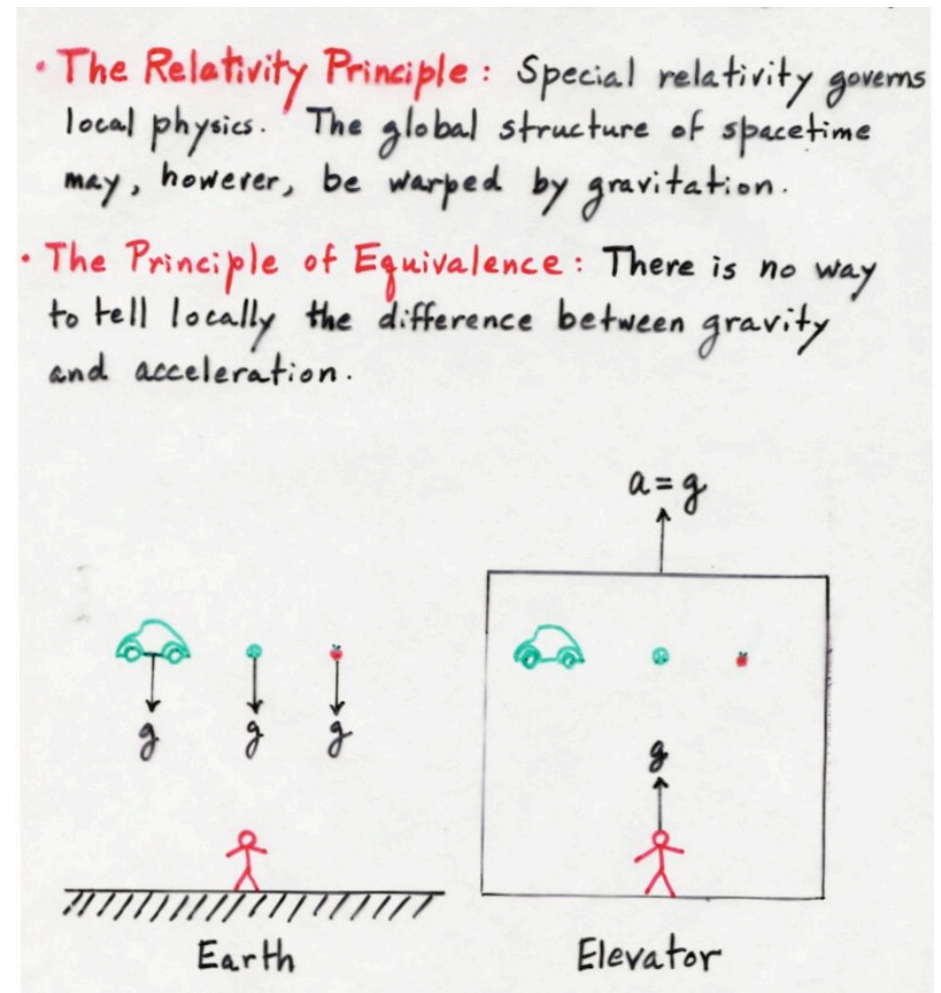

Bending of Light

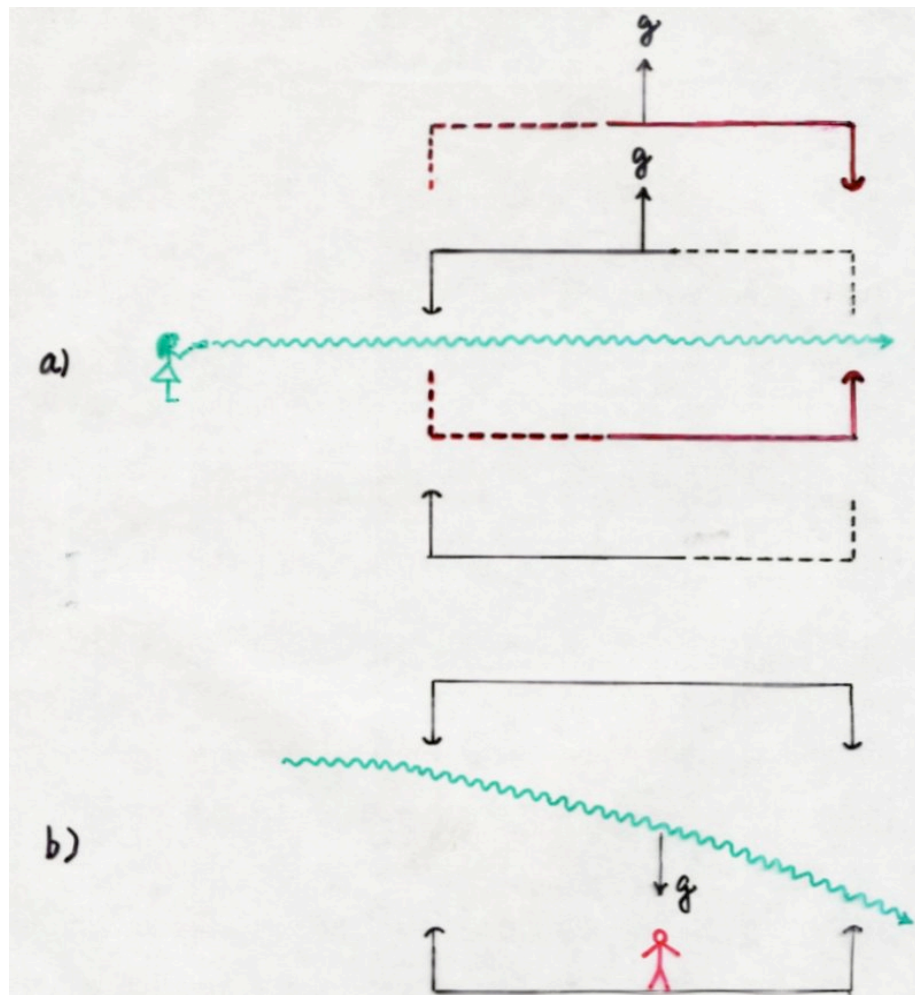

- Woman in unaccelerating inertial space sees that light travels in straight lines.
- Man in accelerating elevator sees light bend relative to windows of elevator.
- By the equivalence principle, he thinks he lives in the gravitational field of the Earth, and therefore he concludes that the gravity of the Earth can bend light.
- Who is right? **They both are!**
- But what do we then mean by straight if that is not the path that light takes?
- **Maybe it's space (and time) that's warped by gravitation!**

Ant Analogy for Bending of Light

- Newton:
 - Gravity is a force which pulls on all things with mass (even light corpuscles?).
 - Mass acts as the source that generates the force of gravitation.
- Einstein:
 - There is no such thing as the force of gravity. Gravitation arises when spacetime has curvature; indeed gravitation is spacetime curvature.
 - Mass-energy and stress (e.g., pressure) act as the sources that generate spacetime curvature.

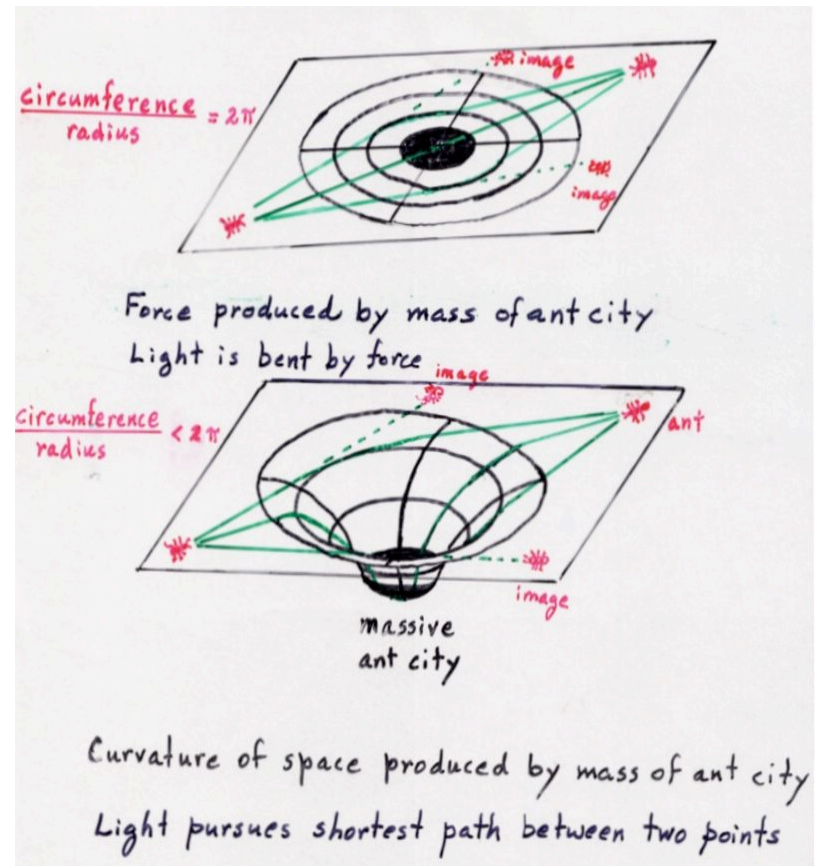

Amount of bending predicted by Einstein's viewpoint is twice Newtonian picture. Reason: time slows down near the massive ant city, and light has more time to make bend.

Gravitational Bending of Light by Sun

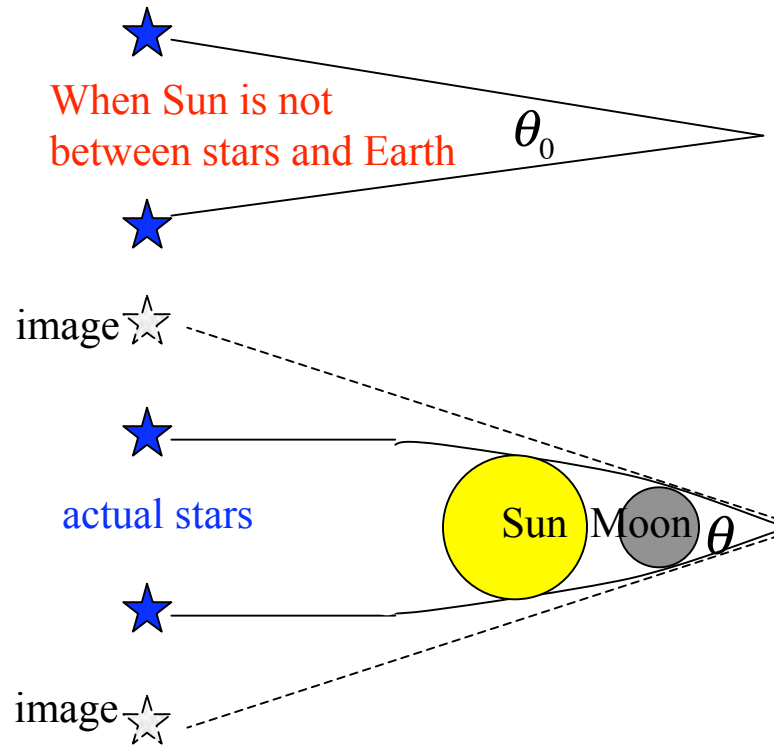

$\theta > \theta_0$, difference predicted by Einstein twice as big as would have been predicted by Newton

Without Moon to block light from Sun, cannot see background stars. Eclipse expedition of 1919 headed by Eddington at end of World War I to test prediction of general relativity.
Reaction of Einstein on hearing the news.



London Times November 7, 1919: Revolution in Science, New Theory of the Universe, Newtonian Ideas Overthrown

Microlensing by Massive Compact Halo Objects, Probably WDs (extra material)

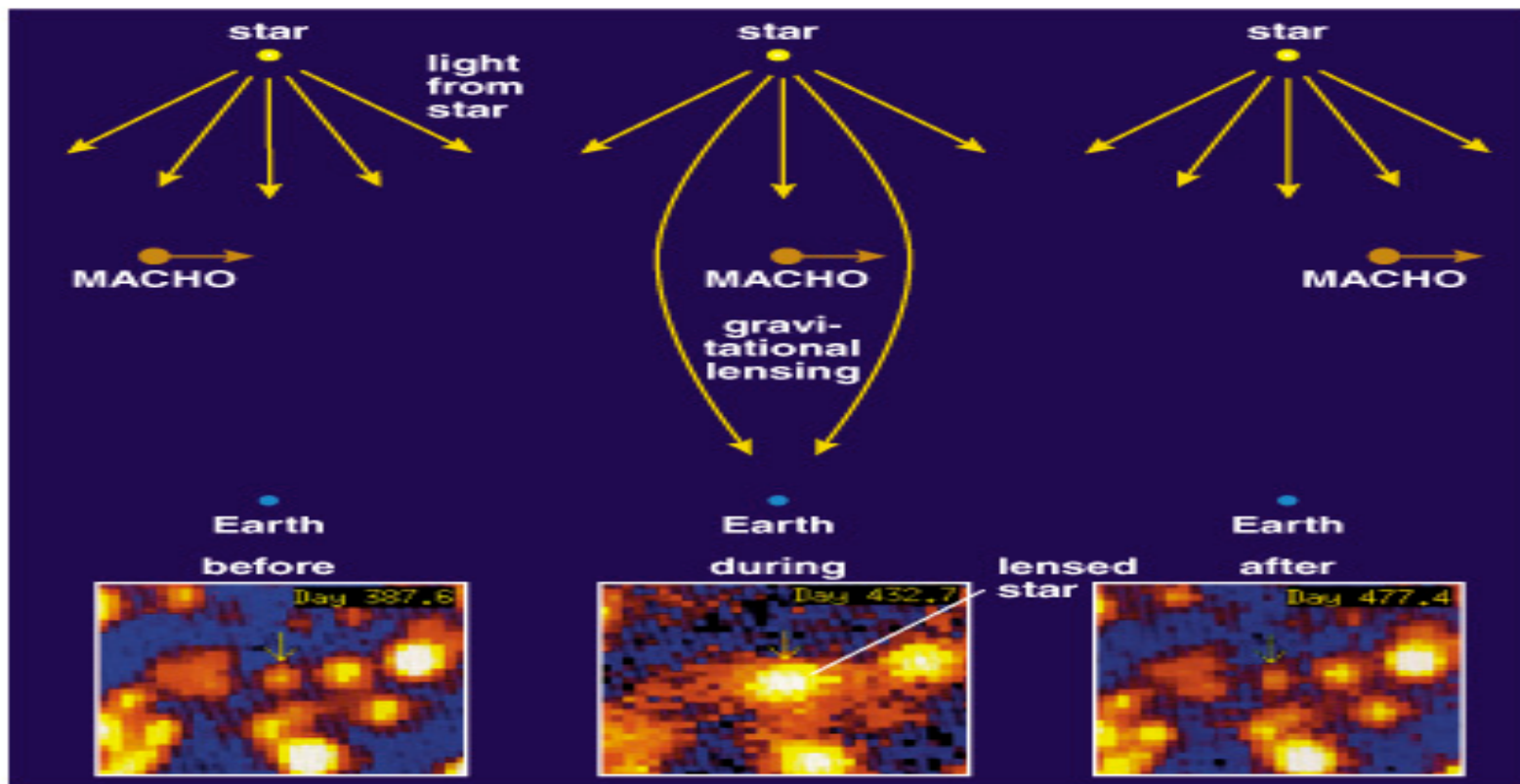

Copyright © Addison Wesley.

Kim Greist of UCSD is one of world experts on microlensing

Lensing of Background Galaxies by Galaxy Cluster (extra material)

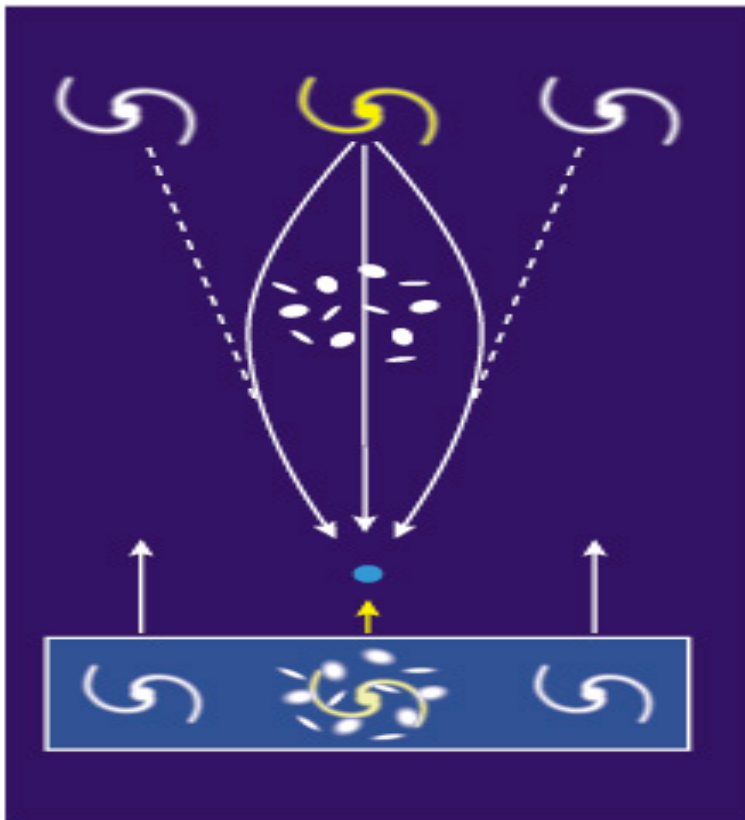

Copyright © Addison Wesley.

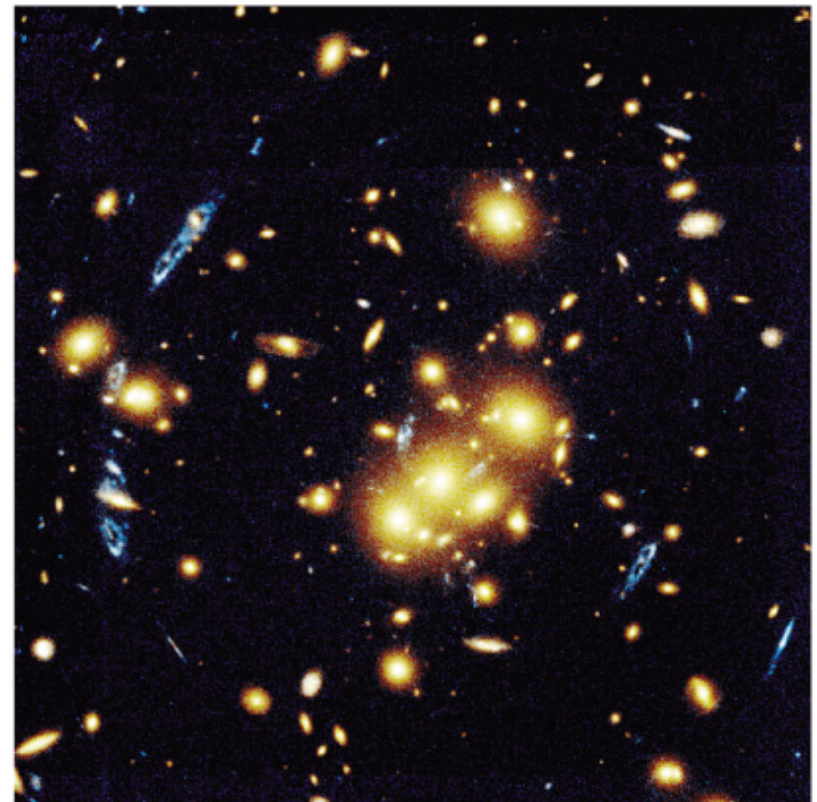

Copyright © Addison Wesley.

Flight Circles about a Black Hole

- $R_{\text{Sch}} = 9$ km for a 3 solar-mass BH.
- Start with flight circle of circumference = $2\pi \cdot 90$ km.
- You deduce you're 90 km radially from BH. Don't jump to conclusions.
- Lower yourself inward radially by 32 km.
- Fly around; measure circumference = $2\pi \cdot 60$ km. (?)
- Lower yourself inward radially by another 33.75 km.
- Fly around; measure circumference = $2\pi \cdot 30$ km. (?)
- Lower yourself inward radially by another 19.8 km.
- You compute $32 + 33.75 + 19.8 = 85.55$. Subtracted from original 90, won't this bring you inside $R_{\text{Sch}} = 9$ km? (!)
- Don't worry; lower yourself by 19.8 km as we requested.
- Fly around; measure circumference = $2\pi \cdot 15$ km. Whew!
- All flight circles are in a single plane. Clearly, presence of a 3 solar-mass point-mass at center has warped our usual (Euclidean) sense of geometry.

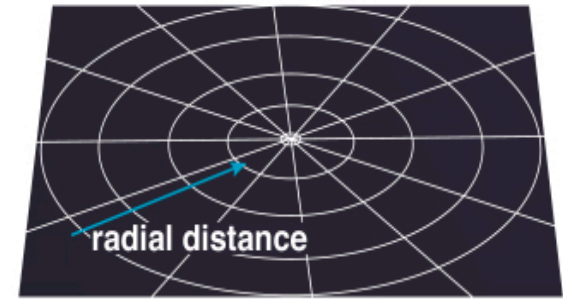

(a) Relationship between flight circles in a single plane and radial distance in Euclidean geometry

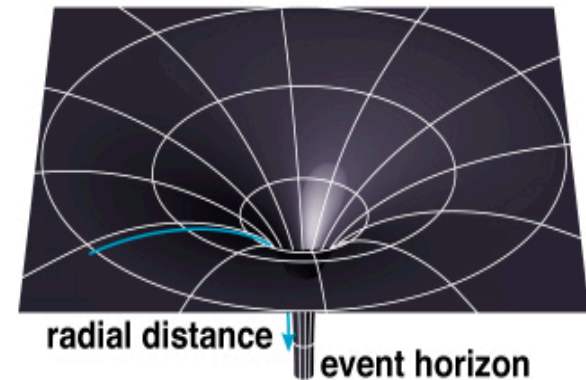

(b) Same relationship when space is curved and punctured by gravitation of a black hole.

Reversal of Space and Time Across Event Horizon of a Black Hole

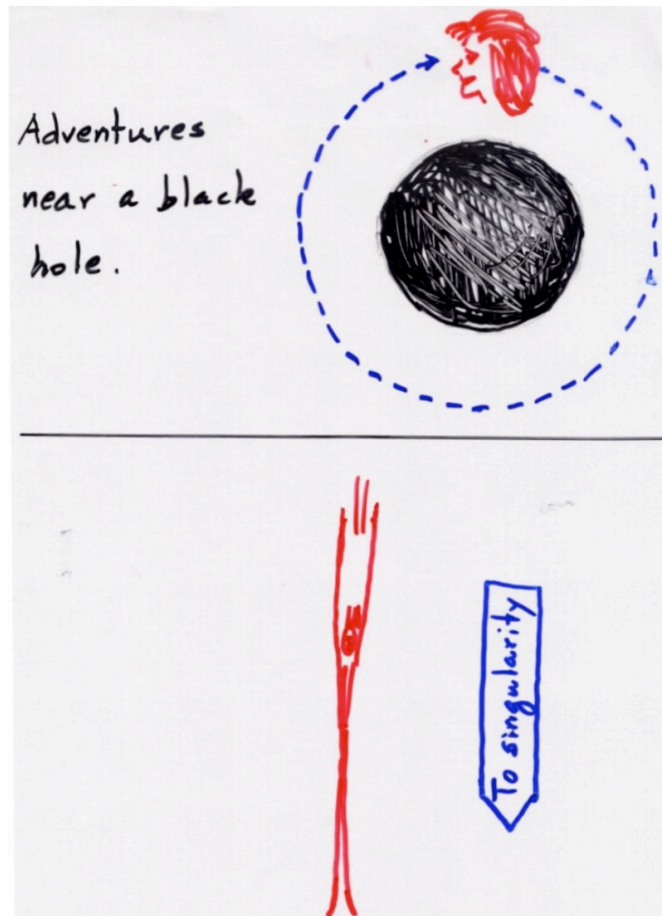

- Outside event horizon, by exerting enough force on the rope, I can hold your position stationary with respect to center of BH. But there is nothing I can do to stop the forward progression of time for you (or, for that matter, for myself).
- As I lower you toward event horizon, your perception of stars begin to change and blur. Are you getting a sinking feeling?
- When you get close enough to the event horizon, no rope – no matter how strong – can stand the strain. It will snap and break, and you will begin an inexorable fall toward the black hole.
- For you, it takes only a few milliseconds for you to reach and cross the event horizon of the BH. But for me, it seems that you formally take an eternity to reach the event horizon.
- In other words, as you draw near to the event horizon, there is nothing I can do to stop your forward progression through space. But for me, time seems to have stopped moving for you! In some sense, for me on the outside, time and space seem to reverse roles as you approach the event horizon. When you cross it, you will reach a different space and time than the one that we on the outside occupy. In a certain sense, BHs may be portals to other spacetimes and other universes!

Speculation 1-- Wormholes: Shortcuts through Space? (extra material)

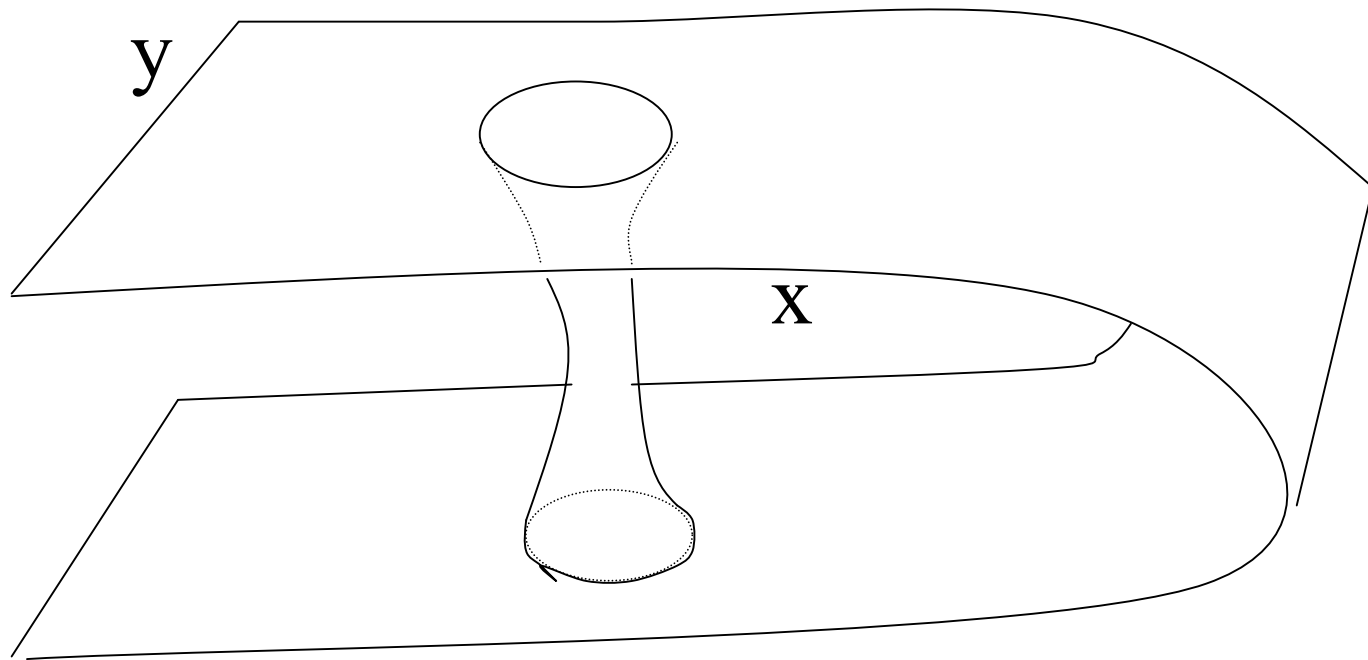

Speculation 2 -- Wormholes: Machines through Time? (extra material)

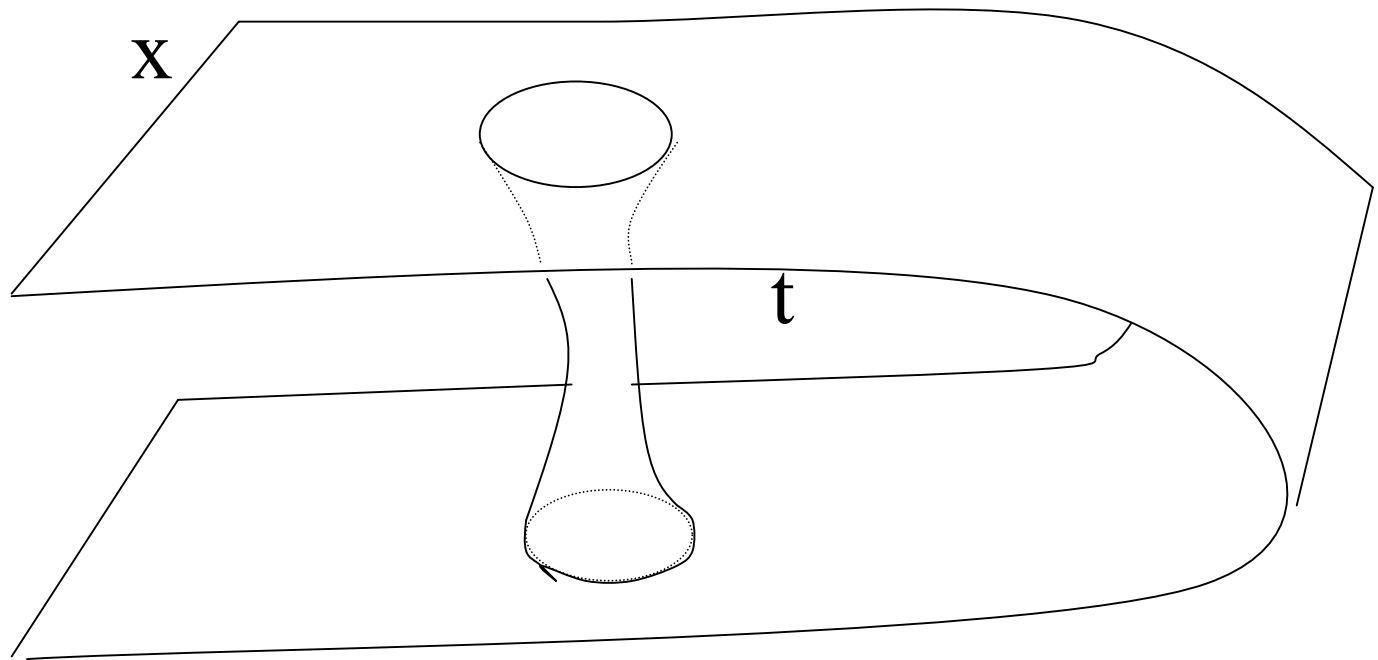

Detectability of Black Holes

- Since black holes allow nothing to escape from their “surfaces,” not even photons, how can we detect them or verify their existence?
- One technique examines the radiation from matter drawn from a closely orbiting star before this material falls into the black hole in binary X-ray sources. Radiation is associated with an *accretion disk* surrounding the black hole.
- Famous example -- Cygnus X-1: Inference for *compact (unseen) companion in excess of 3 solar masses* orbiting a normal star.
- Data accumulated over the past several years show the somewhat surprising result that most *stellar-mass black holes* found in this manner have a fairly narrow range of masses of around *7 solar masses*.

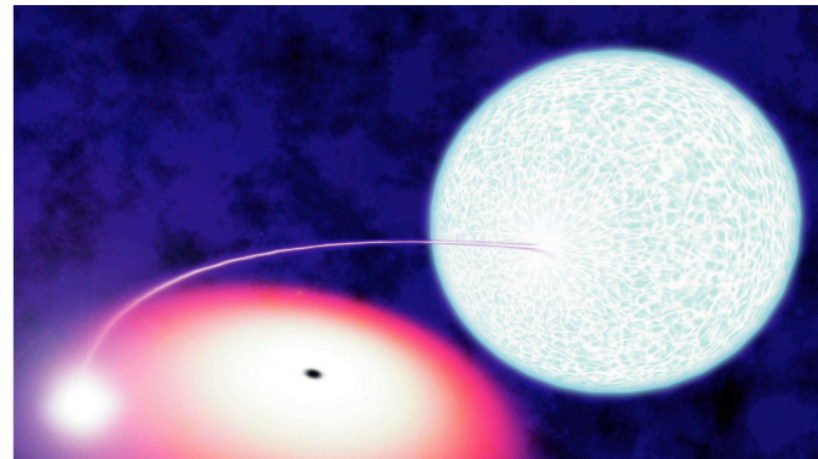
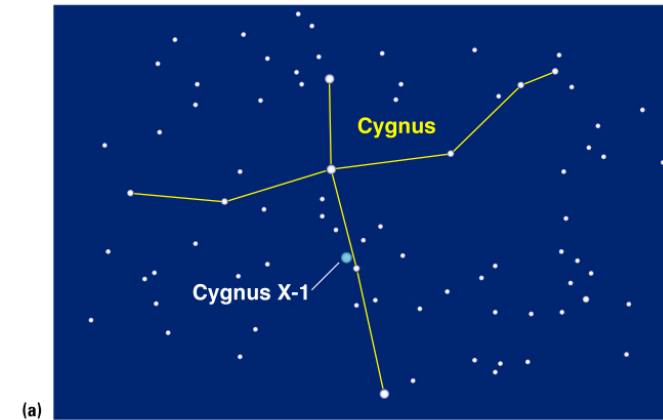

Model of Cygnus X-1

Final Stellar States in War between Gravity & Thermodynamics

White Dwarf	Truce mediated by quantum behavior of electrons
Neutron Star	Truce mediated by quantum behavior of neutrons
Black Hole	Final victory for gravity over thermodynamics
Nothing Left	Final victory of thermodynamics over gravity (only true equilibrium?)

Speculation 3: Evaporation of BHs? (extra material)

- Currently popular theoretical view: Proton is a long-lived, but ultimately unstable particle, which will decay into positron plus other particles in some 10^{32} years or so.
- If this speculation is correct, then ultimately all the protons (and neutrons, which will decay into protons if the latter disappear) in WDs and NSs will turn into positrons that will annihilate with the electrons present in these compact objects. The resulting photons (and other massless particles) will then escape at the speed of light and disappear into the universe.
- Even BHs may ultimately evaporate completely away if Stephen Hawking (1943-) is correct. According to Hawking, (nonrotating) BHs of a mass M have a nonzero surface temperature T given by the formula:

$$kT = \frac{\hbar c^3}{8\pi GM}.$$

True End State of Universe?

(extra material)

- Today, BHs preferentially pull in matter and become more massive. But eventually (and this may take a long, long time), when all the neighboring matter is gone and the night sky has become even darker than it is now, BHs will begin to slowly lose mass and energy back into the universe.
- Since T is inversely proportional to M , this process will accelerate with time as M becomes smaller and smaller, until the BH disappears in a final outburst of light (leaving behind, perhaps, only a Planck-mass remnant – more later).
- The whole story of stellar evolution is to turn normal stars into more and more compact objects, ultimately producing WDs, NSs, or BHs. However, if current theoretical ideas are correct that most forms of matter are ultimately unstable toward decay into lighter particles, with even black holes not immune from the disease, then the end game of the evolution of the universe will see a redispersal of the gravitationally bound “final states” of stellar evolution.
- Is the grand scheme of the cosmos then merely a mechanism to turn matter into energy? This would be an ironic end if current ideas are also correct, that all matter in the universe originally began in the big bang as pure energy.